



Dealers Industrial Equipment

No.:

Date: 13-SEP-2016

Customer :

TECHNICAL PROPOSAL

Three-phase induction motor - Squirrel cage rotor

Product line : W01 (Rolled Steel) General Purpose ODP

Catalog Number : 00736OT3E184T-SG

List Price : \$1,090

Notes:

Downloaded from <http://dealerselectric.com>

Generated for Model #00736OT3E184T-SG

Performed by:

Checked:



Dealers Industrial Equipment

No.:

Date: 13-SEP-2016

DATA SHEET Three-phase induction motor - Squirrel cage rotor

Customer :
Product line : W01 (Rolled Steel) General Purpose ODP

Frame : 182/4T
Output : 7.5 HP
Frequency : 60 Hz
Poles : 2
Full load speed : 3500 rpm
Slip : 2.78 %
Voltage : 208-230/460 V
Rated current : 19.2-17.3/8.67 A
Locked rotor current : 128/64.2 A
Locked rotor current (I_L/I_n) : 7.4
No-load current : 6.43/3.22 A
Full load torque : 11.1 lb.ft
Locked rotor torque : 180 %
Breakdown torque : 290 %
Design : B
Insulation class : F
Temperature rise : 80 K
Locked rotor time : 10 s (hot)
Service factor : 1.15
Duty cycle : S1
Ambient temperature : -20°C - +40°C
Altitude : 1000 m
Degree of Protection : ODP
Approximate weight : 70 lb
Moment of inertia : 0.18177 sq.ft.lb
Noise level : 65 dB(A)

	D.E.	N.D.E.
Bearings	6206 ZZ	6205 ZZ
Regreasing interval	---	---
Grease amount	---	---

Load	Power factor	Efficiency (%)
100%	0.90	88.5
75%	0.85	88.5
50%	0.76	88.5

Notes:
Downloaded from <http://dealerselectric.com>
Generated for Model #00736OT3E184T-SG

Performed by

Checked



Dealers Industrial Equipment

No.:

Date: 13-SEP-2016

PERFORMANCE CURVES RELATED TO RATED OUTPUT

Three-phase induction motor - Squirrel cage rotor

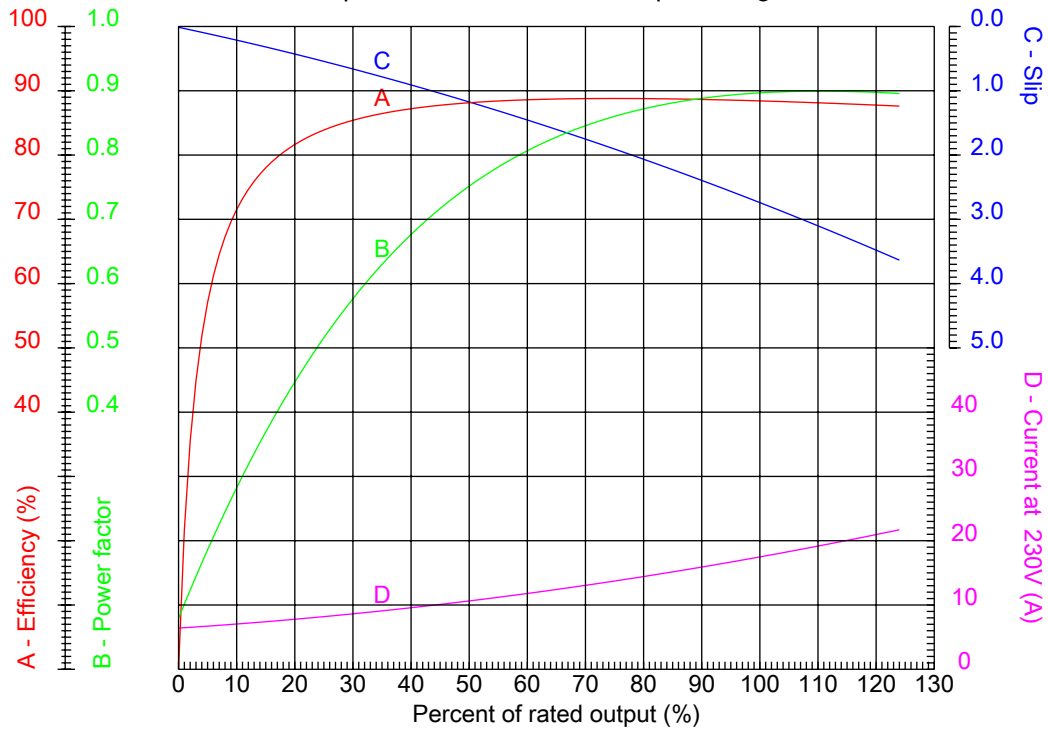

Customer :
Product line : W01 (Rolled Steel) General Purpose ODP

Frame : 182/4T	Locked rotor current (I _L /I _n) : 7.4
Output : 7.5 HP	Duty cycle : S1
Frequency : 60 Hz	Service factor : 1.15
Full load speed : 3500 rpm	Design : B
Voltage : 208-230/460 V	Locked rotor torque : 180 %
Rated current : 19.2-17.3/8.67 A	Breakdown torque : 290 %
Insulation class : F	

Notes:
Downloaded from <http://dealerselectric.com>
Generated for Model #00736OT3E184T-SG

Performed by

Checked



CHARACTERISTIC CURVES RELATED TO SPEED

Three-phase induction motor - Squirrel cage rotor

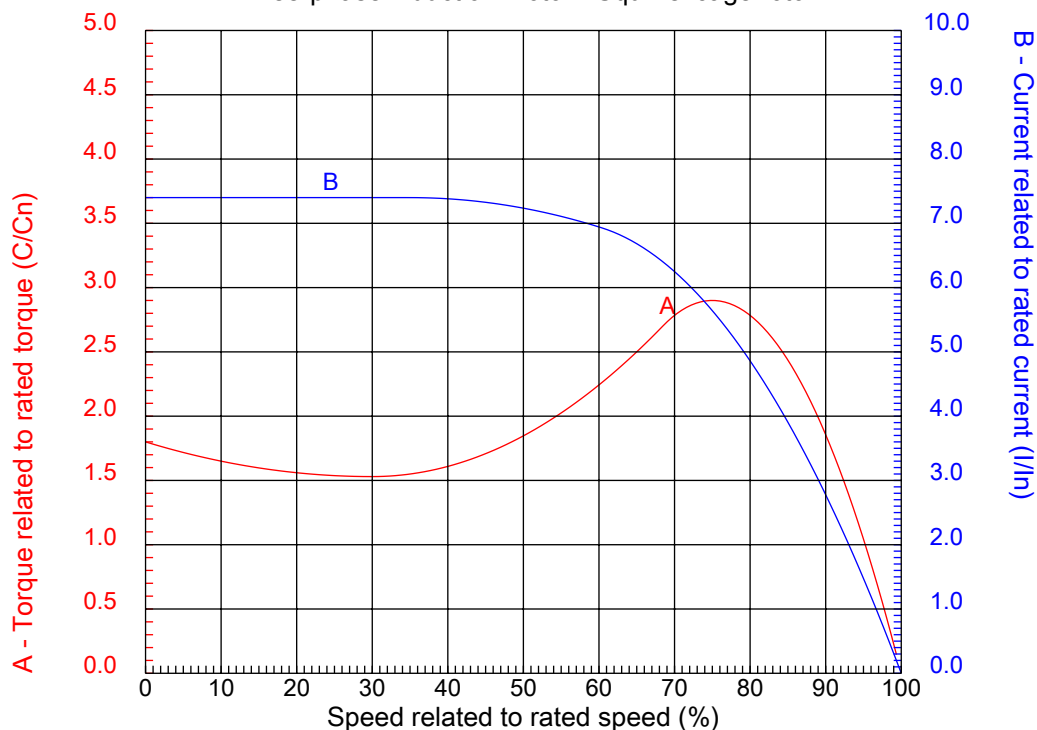

Customer :
Product line : W01 (Rolled Steel) General Purpose ODP

Frame	: 182/4T	Locked rotor current (I _l /I _n)	: 7.4
Output	: 7.5 HP	Duty cycle	: S1
Frequency	: 60 Hz	Service factor	: 1.15
Full load speed	: 3500 rpm	Design	: B
Voltage	: 208-230/460 V	Locked rotor torque	: 180 %
Rated current	: 19.2-17.3/8.67 A	Breakdown torque	: 290 %
Insulation class	: F		

Notes:
Downloaded from <http://dealerselectric.com>
Generated for Model #00736OT3E184T-SG

Performed by

Checked

1 2 3 4 5 6 7 8

A

B

C

D

E

F

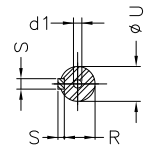
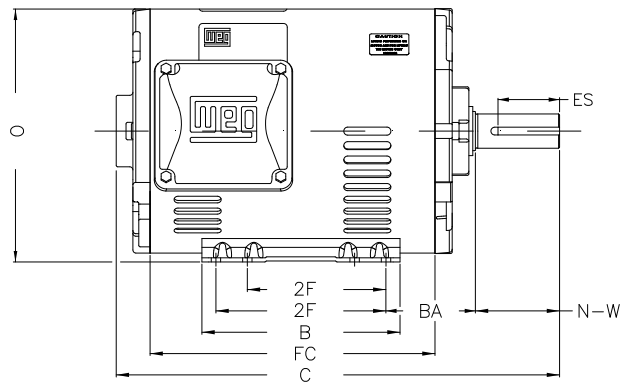
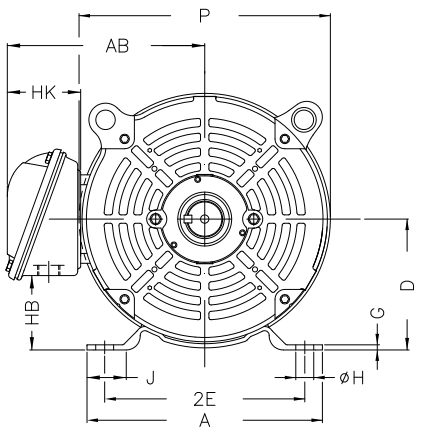
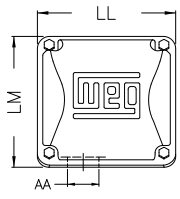

Notes: Downloaded from <http://dealerselectric.com>
Generated for Model #007360T3E184T-SG

Performed by:

Checked:

Customer:

W01 (Rolled Steel) General Purpose ODP

Three-phase induction motor
Frame 182/4T - ODP

13-SEP-2016



P	AB	J	2E	A
8.114	6.696	1.299	7.500	8.661
H	G	HB	HK	O
0.406	0.167	2.784	2.629	8.557
FC	2F	B	C	BA
9.055	4.500/5.500	6.299	15.157	2.750
N-W	ES	d1	S	U
2.750	1.969	A 3,15	0.250	1.125
AA	depth	R	LL	LM
1.118"	0.250	0.984	4.563	4.090
BB	D	CH		
0.000	4.500	1.377		

1 2 3 4 5 6 7 8

LOW VOLTAGE

HIGH VOLTAGE

A
B
C
D
E
F

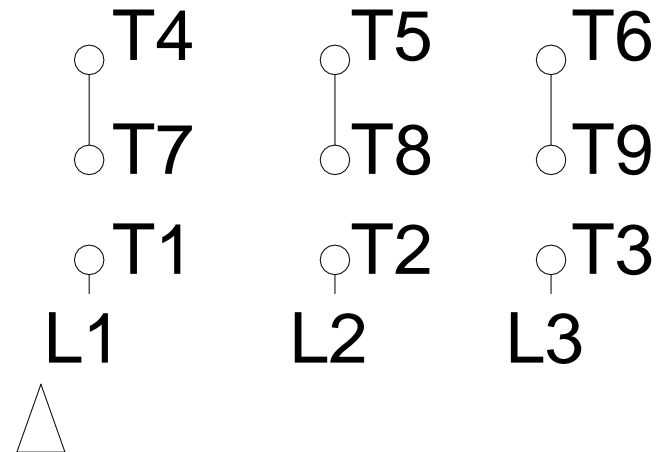

Notes: Downloaded from http://dealerselectric.com Generated for Model #007360T3E184T-SG		
Performed by:		
Checked:		
Customer:		
W01 (Rolled Steel) General Purpose ODP		
Three-phase induction motor Frame 182/4T - IP21	13-SEP-2016	