



Dealers Industrial Equipment

No.:

Date: 13-SEP-2016

Customer :

TECHNICAL PROPOSAL

Three-phase induction motor - Squirrel cage rotor

Product line : Three Phase: W01 (Rolled Steel) - TEFC - NEMA Premium Efficiency

Catalog Number : 00736ET3H213T-S

List Price : \$980

Notes:

Downloaded from <http://dealerselectric.com>

Generated for Model #00736ET3H213T-S

Performed by:

Checked:



Dealers Industrial Equipment

No.:

Date: 13-SEP-2016

DATA SHEET Three-phase induction motor - Squirrel cage rotor

Customer :
 Product line : Three Phase: W01 (Rolled Steel) - TEFC - NEMA Premium Efficiency

Frame : 213/5T
 Output : 7.5 HP
 Frequency : 60 Hz
 Poles : 2
 Full load speed : 3530 rpm
 Slip : 1.94 %
 Voltage : 575 V
 Rated current : 6.94 A
 Locked rotor current : 52.7 A
 Locked rotor current (I_L/I_n) : 7.6
 No-load current : 2.65 A
 Full load torque : 11.0 lb.ft
 Locked rotor torque : 260 %
 Breakdown torque : 300 %
 Design : B
 Insulation class : F
 Temperature rise : 80 K
 Locked rotor time : 15 s (hot)
 Service factor : 1.15
 Duty cycle : S1
 Ambient temperature : -20°C - +40°C
 Altitude : 1000 m
 Degree of Protection : IP55
 Approximate weight : 133 lb
 Moment of inertia : 0.54959 sq.ft.lb
 Noise level : 70 dB(A)

	D.E.	N.D.E.
Bearings	6208 ZZ	6206 ZZ
Regreasing interval	---	---
Grease amount	---	---

Load	Power factor	Efficiency (%)
100%	0.89	89.5
75%	0.85	88.5
50%	0.76	87.5

Notes:
 Downloaded from <http://dealerselectric.com>
 Generated for Model #00736ET3H213T-S

Performed by

Checked



Dealers Industrial Equipment

No.:

Date: 13-SEP-2016

PERFORMANCE CURVES RELATED TO RATED OUTPUT

Three-phase induction motor - Squirrel cage rotor

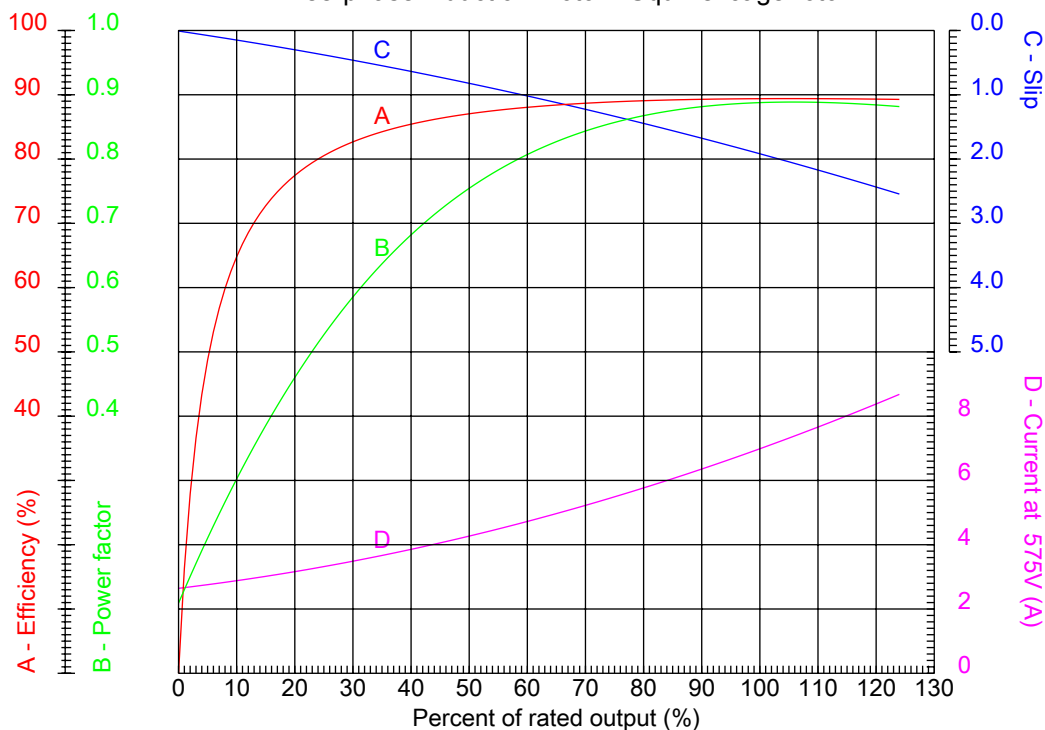

Customer :
Product line : Three Phase: W01 (Rolled Steel) - TEFC - NEMA Premium Efficiency

Frame : 213/5T	Locked rotor current (I _l /I _n) : 7.6
Output : 7.5 HP	Duty cycle : S1
Frequency : 60 Hz	Service factor : 1.15
Full load speed : 3530 rpm	Design : B
Voltage : 575 V	Locked rotor torque : 260 %
Rated current : 6.94 A	Breakdown torque : 300 %
Insulation class : F	

Notes:
Downloaded from <http://dealerselectric.com>
Generated for Model #00736ET3H213T-S

Performed by

Checked



Dealers Industrial Equipment

No.:

Date: 13-SEP-2016

CHARACTERISTIC CURVES RELATED TO SPEED

Three-phase induction motor - Squirrel cage rotor

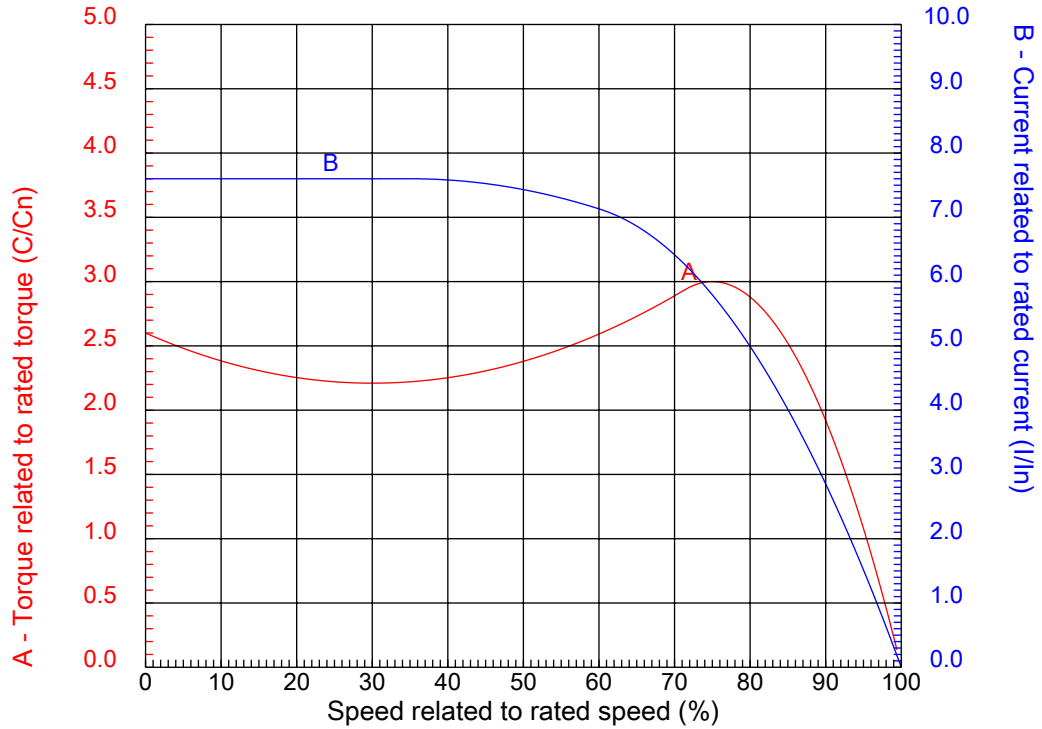

Customer :
Product line : Three Phase: W01 (Rolled Steel) - TEFC - NEMA Premium Efficiency

Frame	: 213/5T	Locked rotor current (I _l /I _n)	: 7.6
Output	: 7.5 HP	Duty cycle	: S1
Frequency	: 60 Hz	Service factor	: 1.15
Full load speed	: 3530 rpm	Design	: B
Voltage	: 575 V	Locked rotor torque	: 260 %
Rated current	: 6.94 A	Breakdown torque	: 300 %
Insulation class	: F		

Notes:
Downloaded from <http://dealerselectric.com>
Generated for Model #00736ET3H213T-S

Performed by

Checked

1 2 3 4 5 6 7 8

A

B

C

D

E

F

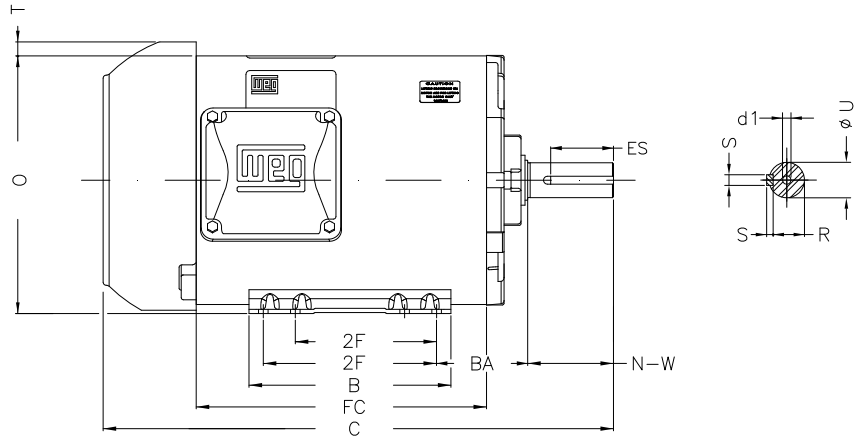
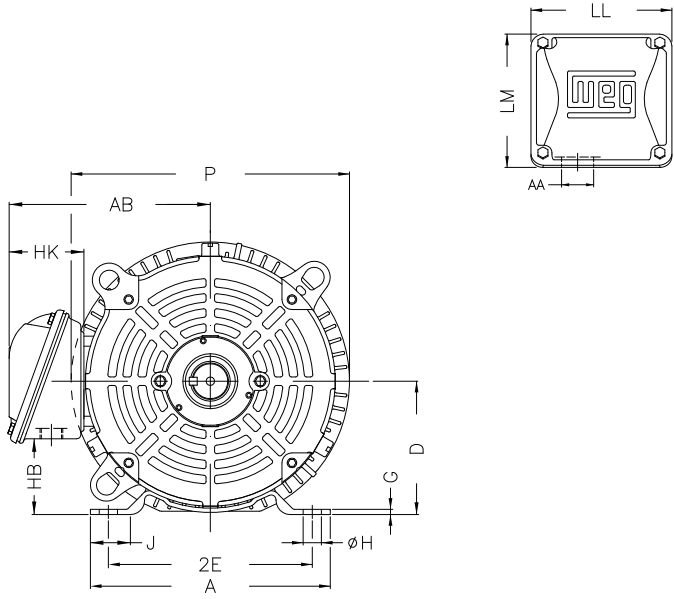

Notes: Downloaded from <http://dealerselectric.com>
Generated for Model #00736ET3H213T-S

Performed by:

Checked:

Customer:

Three Phase: W01 (Rolled Steel) - TEFC - NEMA Premium Efficiency

Three-phase induction motor
Frame 213/5T - IP55

13-SEP-2016



P	AB	J	2E	A
10.965	7.973	1.575	8.500	9.449
H	G	HB	HK	T
0.406	0.167	2.982	3.022	0.761
O	FC	2F	B	C
10.144	11.417	5.500/7.000	7.953	20.079
BA	N-W	ES	d1	S
3.500	3.380	2.480	A4	0.313
U	AA	depth	R	LL
1.375	1.377"	0.313	1.203	5.551
LM	BB	D	CH	
5.250	0.761	5.250	1.929	

1 2 3 4 5 6 7 8

A

B

C

D

E

F



Notes: Downloaded from <http://dealerselectric.com>
Generated for Model #00736ET3H213T-S

Performed by:

Checked:

Customer:

Three Phase: W01 (Rolled Steel) - TEFC - NEMA Premium Efficiency

Three-phase induction motor
Frame 213/5T - IP55

13-SEP-2016

