



Dealers Industrial Equipment

No.:

Date: 13-SEP-2016

Customer :

TECHNICAL PROPOSAL

Three-phase induction motor - Squirrel cage rotor

Product line : Close Coupled Pump: Three-Phase - W01 (Rolled Steel) "JP" Type - TEFC - High Efficiency
Catalog Number : 00736EP3E213JP-S
List Price : \$1,303

Notes:
Downloaded from <http://dealerselectric.com>
Generated for Model #00736EP3E213JP-S

Performed by:

Checked:



Dealers Industrial Equipment

No.:

Date: 13-SEP-2016

DATA SHEET Three-phase induction motor - Squirrel cage rotor

Customer :
 Product line : Close Coupled Pump: Three-Phase - W01 (Rolled Steel) "JP" Type - TEFC - High Efficiency

Frame : 213/5JP
 Output : 7.5 HP
 Frequency : 60 Hz
 Poles : 2
 Full load speed : 3525 rpm
 Slip : 2.08 %
 Voltage : 208-230/460 V
 Rated current : 19.4-17.5/8.76 A
 Locked rotor current : 123/61.3 A
 Locked rotor current (I_L/I_n) : 7.0
 No-load current : 6.94/3.47 A
 Full load torque : 11.0 lb.ft
 Locked rotor torque : 240 %
 Breakdown torque : 310 %
 Design : B
 Insulation class : F
 Temperature rise : 80 K
 Locked rotor time : 13 s (hot)
 Service factor : 1.15
 Duty cycle : S1
 Ambient temperature : -20°C - +40°C
 Altitude : 1000 m
 Degree of Protection : IP55
 Approximate weight : 118 lb
 Moment of inertia : 0.46653 sq.ft.lb
 Noise level : 70 dB(A)

	D.E.	N.D.E.	Load	Power factor	Efficiency (%)
Bearings	6209 ZZ	6206 ZZ	100%	0.89	88.5
Regreasing interval	---	---	75%	0.84	88.5
Grease amount	---	---	50%	0.75	86.5

Notes:
 Downloaded from <http://dealerselectric.com>
 Generated for Model #00736EP3E213JP-S

Performed by

Checked



Dealers Industrial Equipment

No.:

Date: 13-SEP-2016

PERFORMANCE CURVES RELATED TO RATED OUTPUT

Three-phase induction motor - Squirrel cage rotor

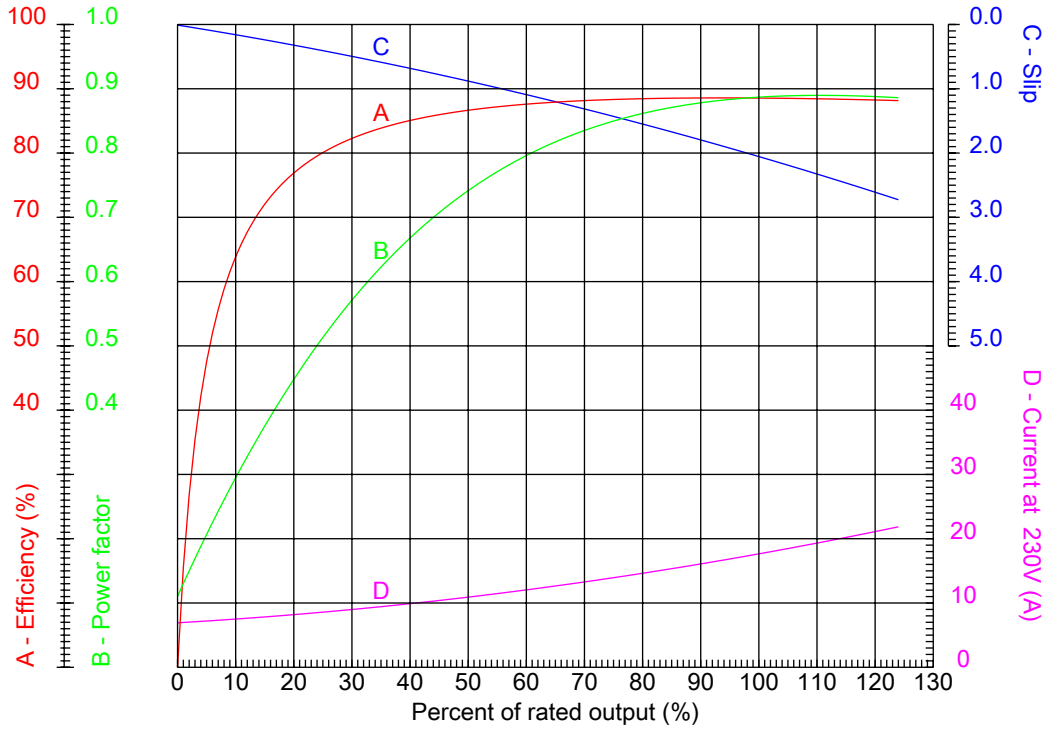

Customer :
 Product line : Close Coupled Pump: Three-Phase - W01 (Rolled Steel) "JP" Type - TEFC - High Efficiency

Frame	: 213/5JP	Locked rotor current (I _l /I _n)	: 7.0
Output	: 7.5 HP	Duty cycle	: S1
Frequency	: 60 Hz	Service factor	: 1.15
Full load speed	: 3525 rpm	Design	: B
Voltage	: 208-230/460 V	Locked rotor torque	: 240 %
Rated current	: 19.4-17.5/8.76 A	Breakdown torque	: 310 %
Insulation class	: F		

Notes:
 Downloaded from <http://dealerselectric.com>
 Generated for Model #00736EP3E213JP-S

Performed by

Checked



Dealers Industrial Equipment

No.:

Date: 13-SEP-2016

CHARACTERISTIC CURVES RELATED TO SPEED

Three-phase induction motor - Squirrel cage rotor

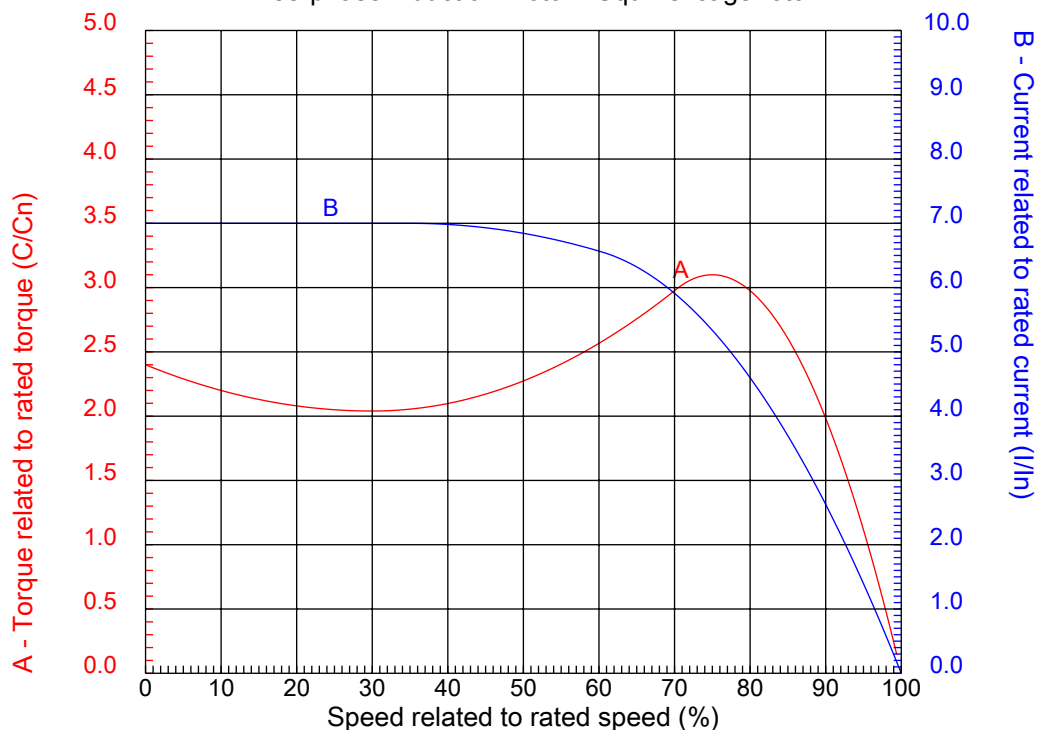

Customer :
Product line : Close Coupled Pump: Three-Phase - W01 (Rolled Steel) "JP" Type - TEFC - High Efficiency

Frame	: 213/5JP	Locked rotor current (I _l /I _n)	: 7.0
Output	: 7.5 HP	Duty cycle	: S1
Frequency	: 60 Hz	Service factor	: 1.15
Full load speed	: 3525 rpm	Design	: B
Voltage	: 208-230/460 V	Locked rotor torque	: 240 %
Rated current	: 19.4-17.5/8.76 A	Breakdown torque	: 310 %
Insulation class	: F		

Notes:
Downloaded from <http://dealerselectric.com>
Generated for Model #00736EP3E213JP-S

Performed by

Checked

1 2 3 4 5 6 7 8

A

B

C

D

E

F

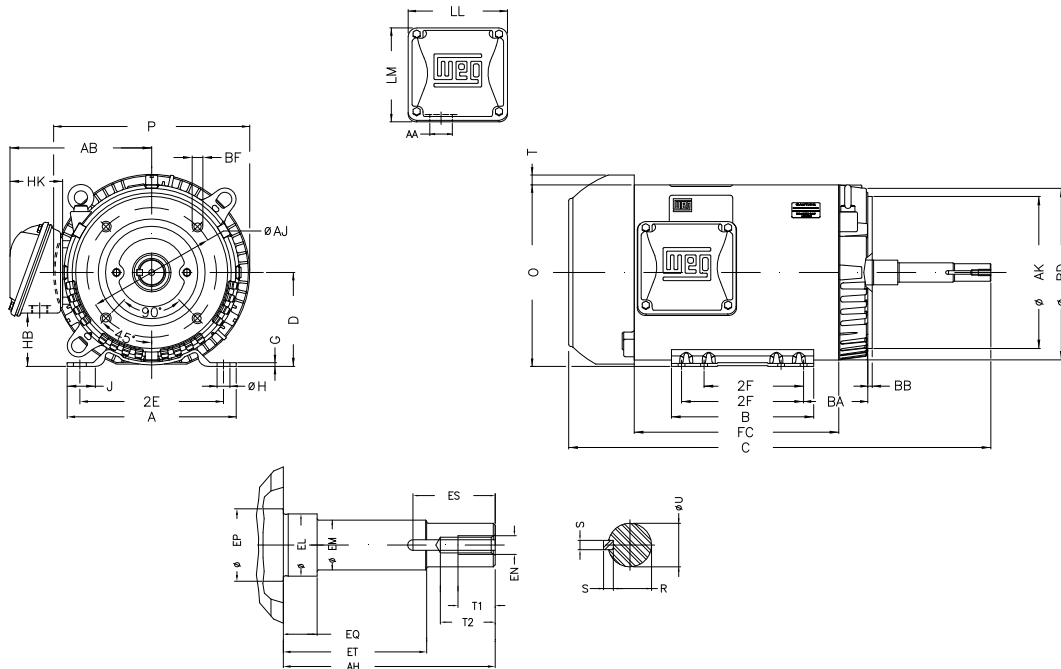

Notes: Downloaded from <http://dealerselectric.com>
Generated for Model #00736EP3E213JP-S

2E 8.500	J 1.575	A 9.449	P 10.965	AB 7.973
2F 5.500/7.000	B 7.953	BA 4.250	D 5.250	G 0.167
O 10.144	T 0.761	H 0.406	AA 1.377"	ER 8.149
EQ 2.374	ET 5.886	U 1.250	EM 1.375	EL 1.750
EP 1.769	ES 2.560	t1 0.984	t2 1.496	C 24.291
CH 1.929	FC 10.630	Flange FC-184	AJ 7.250	AK 8.500
BD 9.401	BF UNC 1/2"x13	BB 0.250	AH 8.130	

Performed by:	
Checked:	
Customer:	
Close Coupled Pump: Three-Phase - W01 (Rolled Steel) "JP" Type - TEFC - High	
Three-phase induction motor Frame 213/5JP - IP55	13-SEP-2016



1 2 3 4 5 6 7 8

LOW VOLTAGE

HIGH VOLTAGE

A
B
C
D
E
F

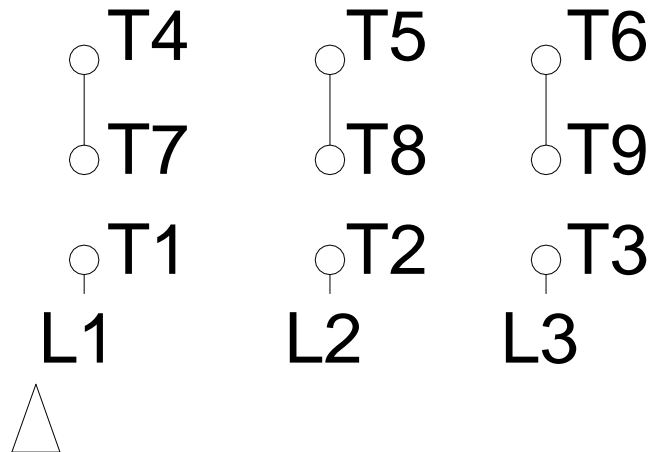
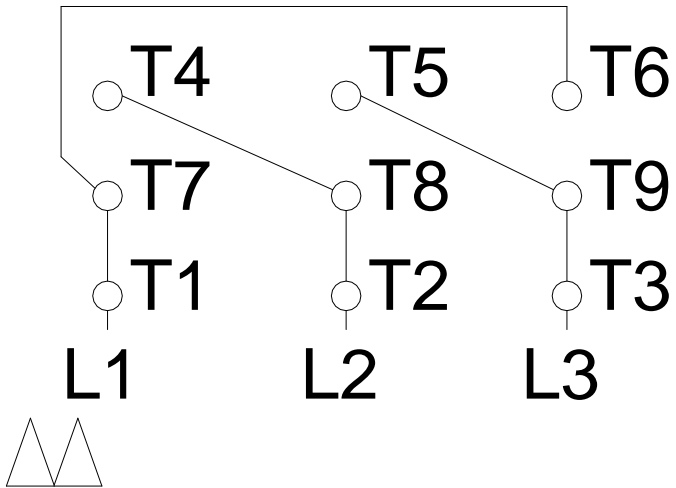

Notes: Downloaded from <http://dealerselectric.com>
 Generated for Model #00736EP3E213JP-S

Performed by:

Checked:

Customer:

Close Coupled Pump: Three-Phase - W01 (Rolled Steel) "JP" Type - TEFC - High

Three-phase induction motor
 Frame 213/5JP - IP55

13-SEP-2016

