



Dealers Industrial Equipment

No.:

Date: 13-SEP-2016

Customer :

TECHNICAL PROPOSAL

Three-phase induction motor - Squirrel cage rotor

Product line : Three-Phase : Explosion Proof - NEMA Premium

Catalog Number : 00718XT3E213TC

List Price : \$2,080

Notes:

Downloaded from <http://dealerselectric.com>

Generated for Model #00718XT3E213TC

Performed by:

Checked:



Dealers Industrial Equipment

No.:

Date: 13-SEP-2016

DATA SHEET Three-phase induction motor - Squirrel cage rotor

Customer :
Product line : Three-Phase : Explosion Proof - NEMA Premium

Frame : 213T
Output : 7.5 HP
Frequency : 60 Hz
Poles : 4
Full load speed : 1765 rpm
Slip : 1.94 %
Voltage : 208-230/460 V
Rated current : 20.8-18.8/9.41 A
Locked rotor current : 126/63.0 A
Locked rotor current (I_L/I_n) : 6.7
No-load current : 9.00/4.50 A
Full load torque : 22.0 lb.ft
Locked rotor torque : 240 %
Breakdown torque : 280 %
Design : B
Insulation class : F
Temperature rise : 80 K
Locked rotor time : 12 s (hot)
Service factor : 1.15
Duty cycle : S1
Ambient temperature : -20°C - +40°C
Altitude : 1000 m
Degree of Protection : IP55
Approximate weight : 152 lb
Moment of inertia : 1.3799 sq.ft.lb
Noise level : 58 dB(A)

	D.E.	N.D.E.
Bearings	6308 2RS	6207 2RS
Regreasing interval	---	---
Grease amount	---	---

Load	Power factor	Efficiency (%)
100%	0.80	91.7
75%	0.73	90.2
50%	0.60	88.5

Notes:
Downloaded from <http://dealerselectric.com>
Generated for Model #00718XT3E213TC

Performed by

Checked



Dealers Industrial Equipment

No.:

Date: 13-SEP-2016

PERFORMANCE CURVES RELATED TO RATED OUTPUT

Three-phase induction motor - Squirrel cage rotor

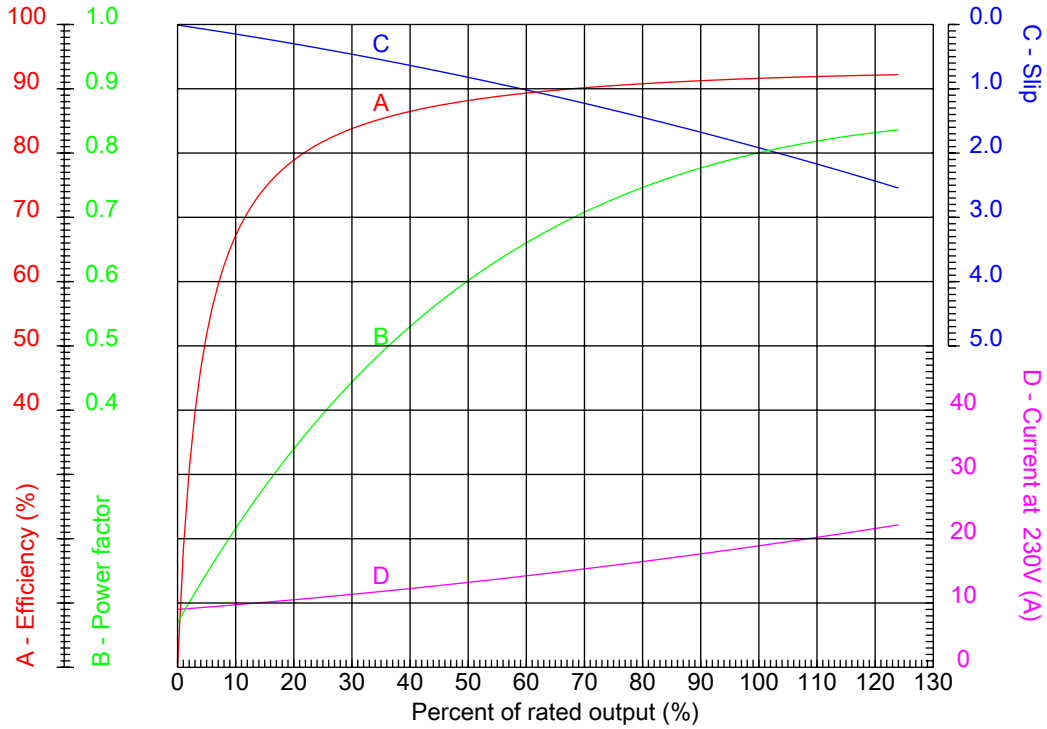

Customer :
 Product line : Three-Phase : Explosion Proof - NEMA Premium

Frame : 213T	Locked rotor current (I _L /I _n) : 6.7
Output : 7.5 HP	Duty cycle : S1
Frequency : 60 Hz	Service factor : 1.15
Full load speed : 1765 rpm	Design : B
Voltage : 208-230/460 V	Locked rotor torque : 240 %
Rated current : 20.8-18.8/9.41 A	Breakdown torque : 280 %
Insulation class : F	

Notes:
 Downloaded from <http://dealerselectric.com>
 Generated for Model #00718XT3E213TC

Performed by

Checked



Dealers Industrial Equipment

No.:

Date: 13-SEP-2016

CHARACTERISTIC CURVES RELATED TO SPEED

Three-phase induction motor - Squirrel cage rotor

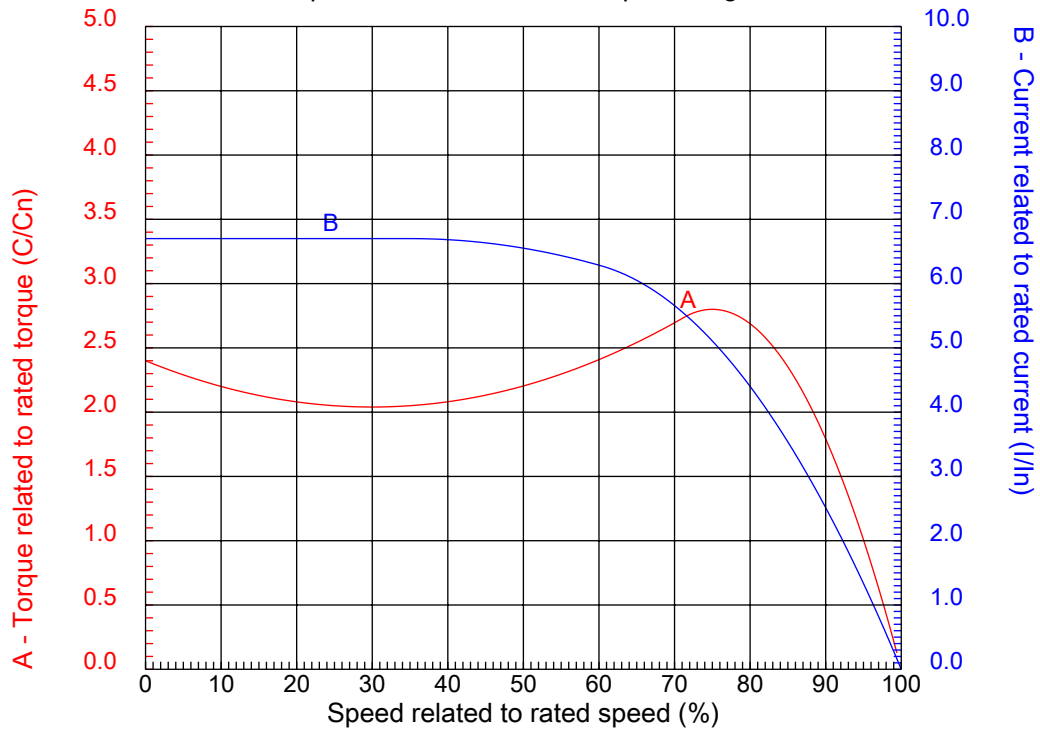

Customer :
Product line : Three-Phase : Explosion Proof - NEMA Premium

Frame	: 213T	Locked rotor current (I _l /I _n)	: 6.7
Output	: 7.5 HP	Duty cycle	: S1
Frequency	: 60 Hz	Service factor	: 1.15
Full load speed	: 1765 rpm	Design	: B
Voltage	: 208-230/460 V	Locked rotor torque	: 240 %
Rated current	: 20.8-18.8/9.41 A	Breakdown torque	: 280 %
Insulation class	: F		

Notes:
Downloaded from <http://dealerselectric.com>
Generated for Model #00718XT3E213TC

Performed by

Checked

1 2 3 4 5 6 7 8

A
B
C
D
E
F

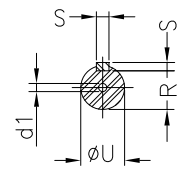
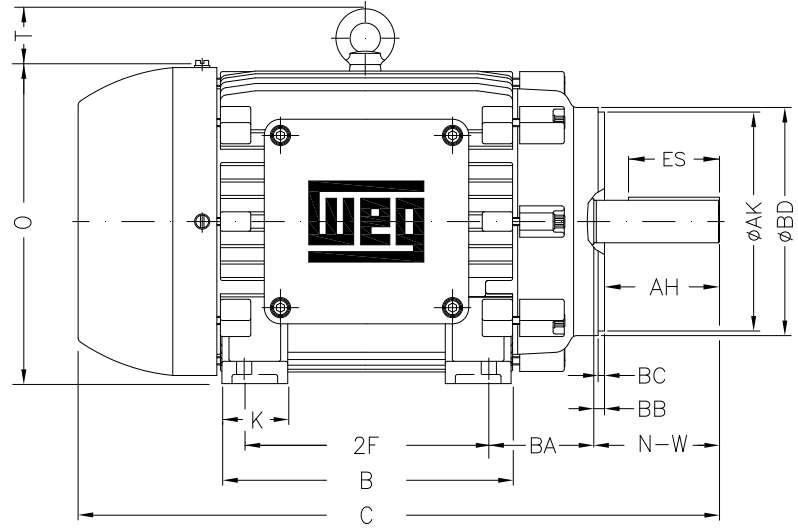
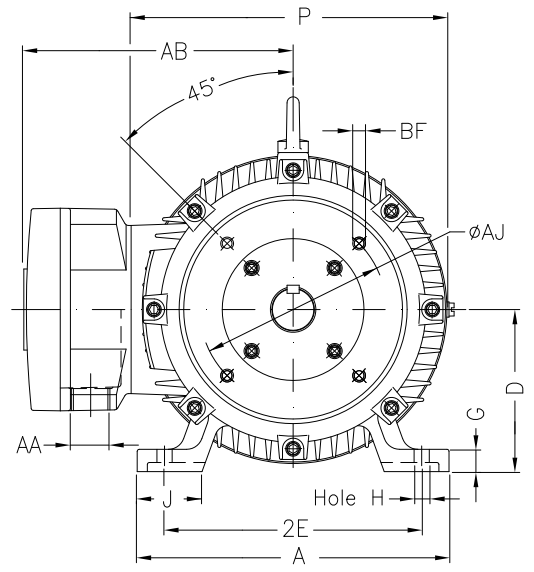

Notes: Downloaded from <http://dealerselectric.com>
Generated for Model #00718XT3E213TC

2E 8.500	A 9.764	2F 5.500	B 7.402	BA 3.500
J 2.008	K 2.165	P 10.709	ES 2.480	depth 0.313
S 0.313	N-W 3.375	U 1.375	R 1.203	AB 9.252
D 5.250	G 0.827	O 11.156	T 1.772	H 0.406
C 17.952	AA NPT 1"	d1 A 4	d2 A 4	Flange FC-184
AJ 7.250	AK 8.500	BD 8.875	BF UNC 1/2"x13	BB 0.250
BC 0.250	AH 3.125			

Performed by:

Checked:

Customer:

Three-Phase : Explosion Proof - NEMA Premium

Three-phase induction motor
Frame 213T - IP55

13-SEP-2016



1 2 3 4 5 6 7 8

LOW VOLTAGE

HIGH VOLTAGE

A
B
C
D
E
F

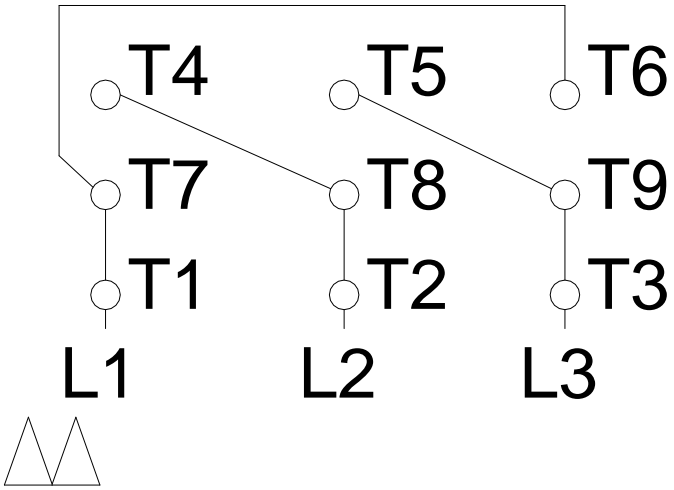

Notes: Downloaded from <http://dealerselectric.com>
 Generated for Model #00718XT3E213TC

Performed by:

Checked:

Customer:

Three-Phase : Explosion Proof - NEMA Premium

Three-phase induction motor
 Frame 213T - IP55

13-SEP-2016

