



Dealers Industrial Equipment

No.:

Date: 13-SEP-2016

Customer :

TECHNICAL PROPOSAL

Three-phase induction motor - Squirrel cage rotor

Product line : Three Phase: W01 (Rolled Steel) - TEFC - NEMA Premium Efficiency

Catalog Number : 00536ET3E184T-S

List Price : \$760

Notes:

Downloaded from <http://dealerselectric.com>

Generated for Model #00536ET3E184T-S

Performed by:

Checked:



Dealers Industrial Equipment

No.:

Date: 13-SEP-2016

DATA SHEET Three-phase induction motor - Squirrel cage rotor

Customer :
 Product line : Three Phase: W01 (Rolled Steel) - TEFC - NEMA Premium Efficiency

Frame : 182/4T
 Output : 5 HP
 Frequency : 60 Hz
 Poles : 2
 Full load speed : 3500 rpm
 Slip : 2.78 %
 Voltage : 208-230/460 V
 Rated current : 13.1-11.8/5.90 A
 Locked rotor current : 92.0/46.0 A
 Locked rotor current (I_L/I_n) : 7.8
 No-load current : 4.40/2.20 A
 Full load torque : 7.40 lb.ft
 Locked rotor torque : 220 %
 Breakdown torque : 300 %
 Design : B
 Insulation class : F
 Temperature rise : 80 K
 Locked rotor time : 17 s (hot)
 Service factor : 1.15
 Duty cycle : S1
 Ambient temperature : -20°C - +40°C
 Altitude : 1000 m
 Degree of Protection : IP55
 Approximate weight : 78 lb
 Moment of inertia : 0.20787 sq.ft.lb
 Noise level : 68 dB(A)

	D.E.	N.D.E.
Bearings	6206 ZZ	6205 ZZ
Regreasing interval	---	---
Grease amount	---	---

Load	Power factor	Efficiency (%)
100%	0.89	88.5
75%	0.85	88.5
50%	0.76	87.5

Notes:
 Downloaded from <http://dealerselectric.com>
 Generated for Model #00536ET3E184T-S

Performed by

Checked



Dealers Industrial Equipment

No.:

Date: 13-SEP-2016

PERFORMANCE CURVES RELATED TO RATED OUTPUT

Three-phase induction motor - Squirrel cage rotor

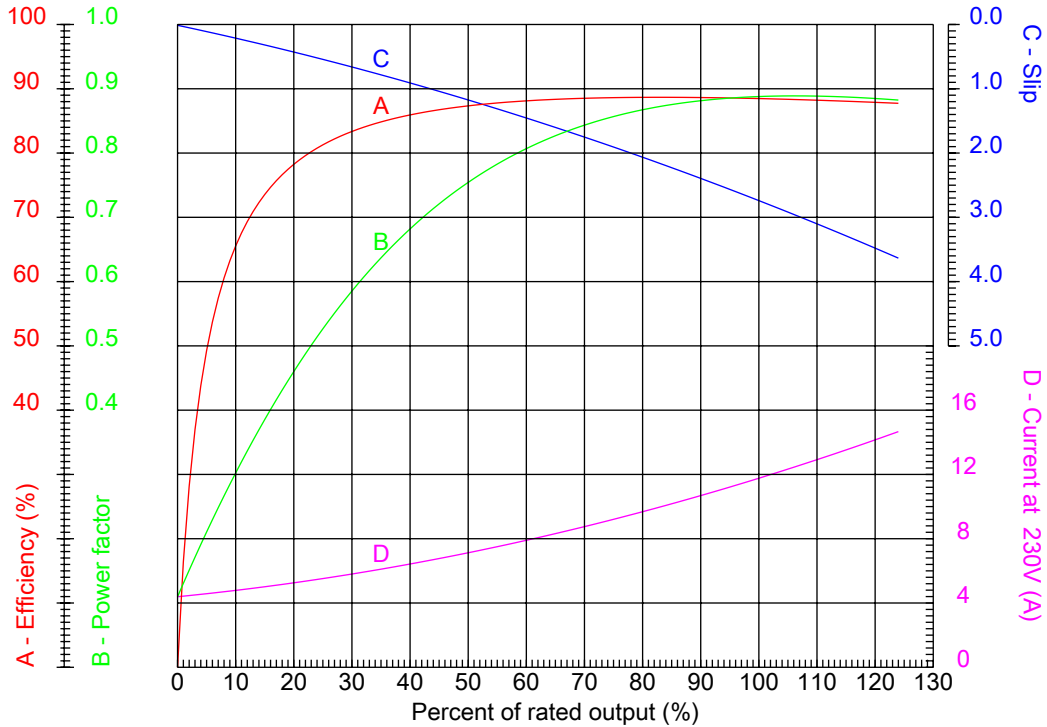

Customer :
 Product line : Three Phase: W01 (Rolled Steel) - TEFC - NEMA Premium Efficiency

Frame	: 182/4T	Locked rotor current (I _l /I _n)	: 7.8
Output	: 5 HP	Duty cycle	: S1
Frequency	: 60 Hz	Service factor	: 1.15
Full load speed	: 3500 rpm	Design	: B
Voltage	: 208-230/460 V	Locked rotor torque	: 220 %
Rated current	: 13.1-11.8/5.90 A	Breakdown torque	: 300 %
Insulation class	: F		

Notes:
 Downloaded from <http://dealerselectric.com>
 Generated for Model #00536ET3E184T-S

Performed by

Checked



Dealers Industrial Equipment

No.:

Date: 13-SEP-2016

CHARACTERISTIC CURVES RELATED TO SPEED

Three-phase induction motor - Squirrel cage rotor

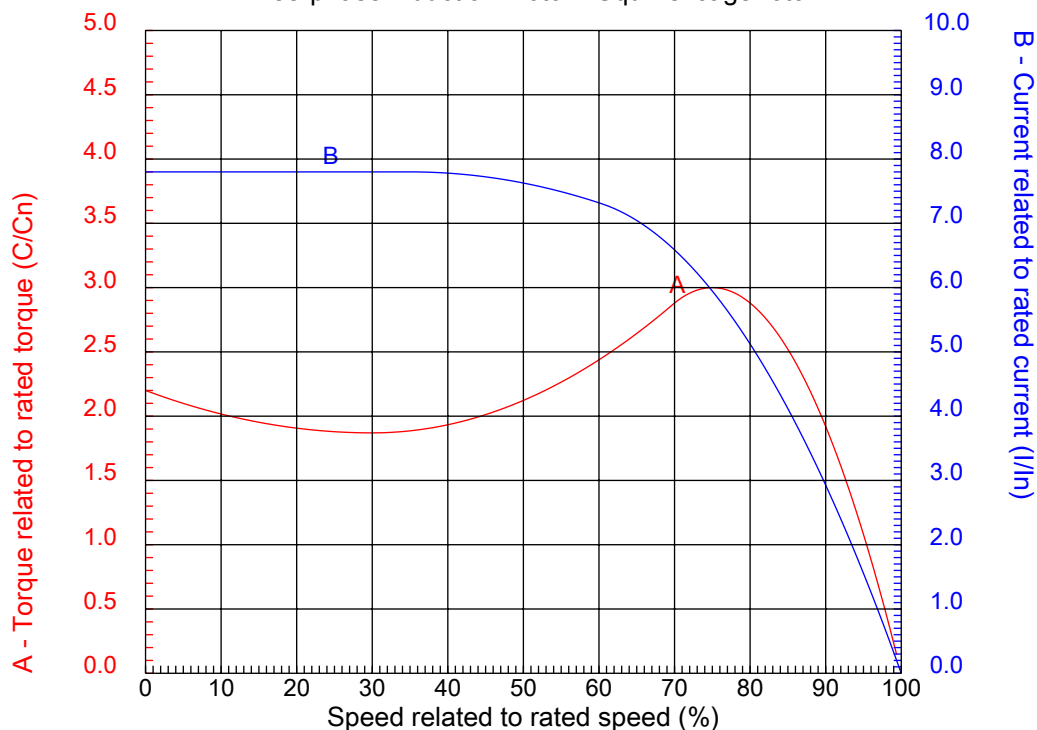

Customer :
Product line : Three Phase: W01 (Rolled Steel) - TEFC - NEMA Premium Efficiency

Frame	: 182/4T	Locked rotor current (I _l /I _n)	: 7.8
Output	: 5 HP	Duty cycle	: S1
Frequency	: 60 Hz	Service factor	: 1.15
Full load speed	: 3500 rpm	Design	: B
Voltage	: 208-230/460 V	Locked rotor torque	: 220 %
Rated current	: 13.1-11.8/5.90 A	Breakdown torque	: 300 %
Insulation class	: F		

Notes:
Downloaded from <http://dealerselectric.com>
Generated for Model #00536ET3E184T-S

Performed by

Checked

1 2 3 4 5 6 7 8

A

B

C

D

E

F

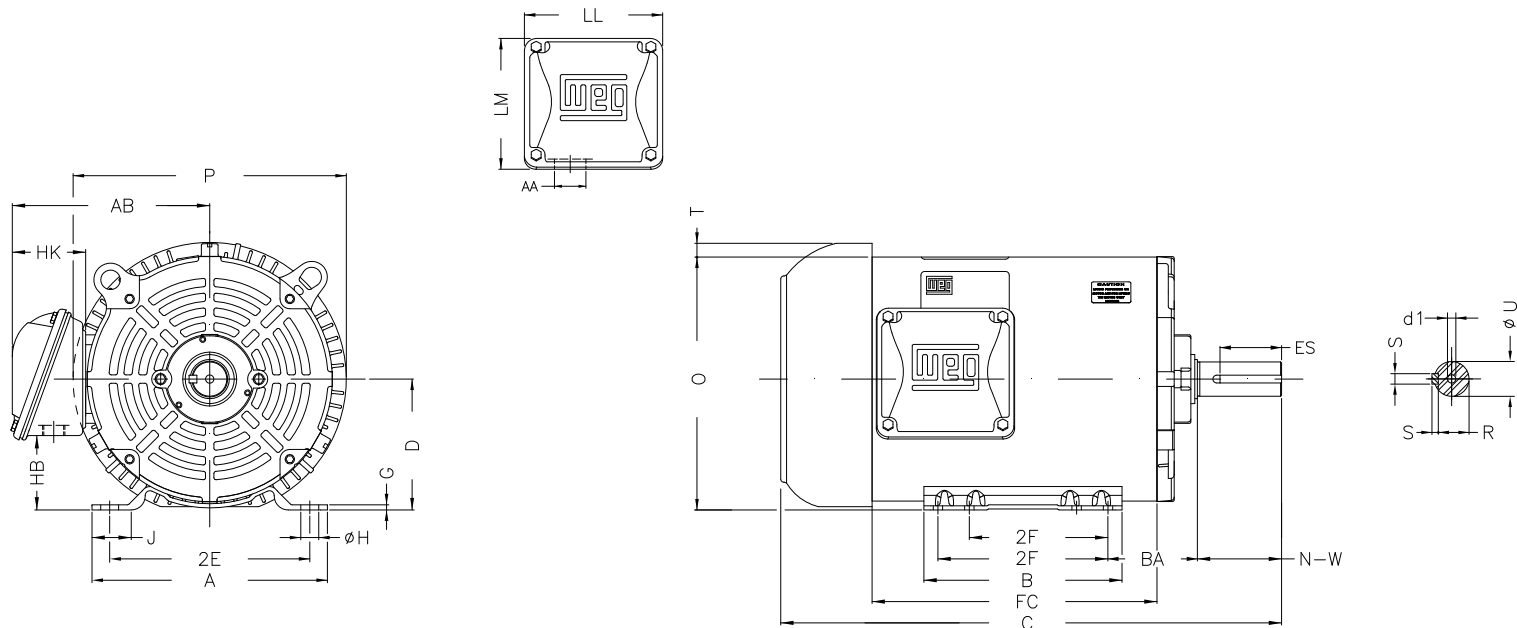

Notes: Downloaded from <http://dealerselectric.com>
Generated for Model #00536ET3E184T-S

Performed by:

Checked:

Customer:

Three Phase: W01 (Rolled Steel) - TEFC - NEMA Premium Efficiency

Three-phase induction motor
Frame 182/4T - IP55

13-SEP-2016



P	AB	J	2E	A
9.435	6.696	1.299	7.500	8.661
H	G	HB	HK	T
0.406	0.167	2.784	2.629	0.661
O	FC	2F	B	C
8.557	10.236	4.500/5.500	6.299	17.913
BA	N-W	ES	d1	S
2.750	2.750	1.969	A 3,15	0.250
U	AA	depth	R	LL
1.125	1.118"	0.250	0.984	4.563
LM	BB	D	CH	
4.090	0.661	4.500	1.377	

1 2 3 4 5 6 7 8

LOW VOLTAGE

HIGH VOLTAGE

A
B
C
D
E
F

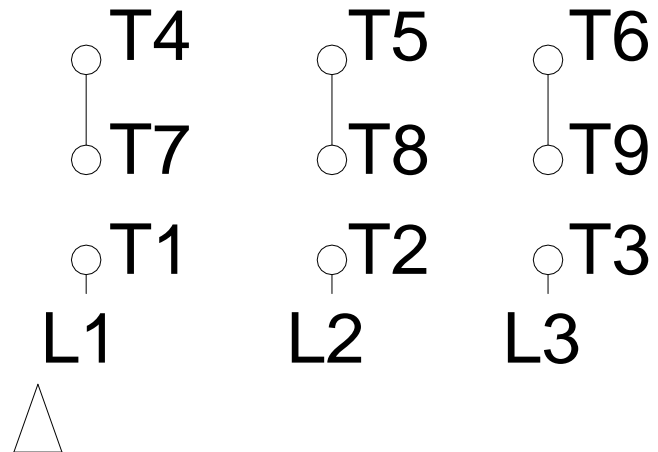
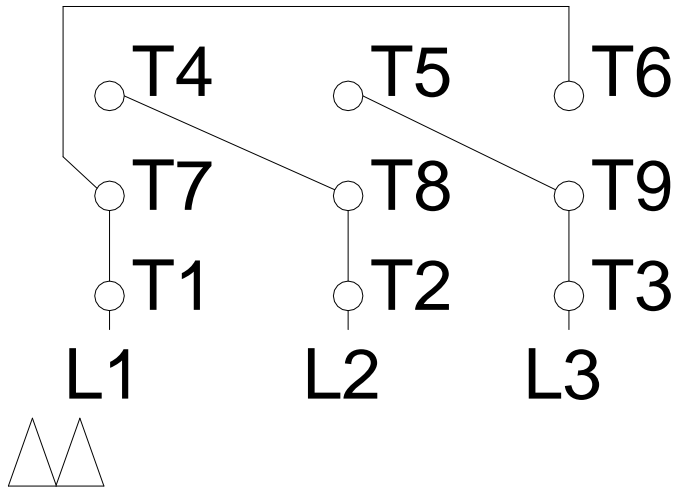

Notes: Downloaded from http://dealerselectric.com Generated for Model #00536ET3E184T-S		
Performed by:		
Checked:		
Customer:		
Three Phase: W01 (Rolled Steel) - TEFC - NEMA Premium Efficiency		
Three-phase induction motor Frame 182/4T - IP55	13-SEP-2016	