



Dealers Industrial Equipment

No.:

Date: 13-SEP-2016

Customer :

TECHNICAL PROPOSAL

Three-phase induction motor - Squirrel cage rotor

Product line : Close Coupled Pump: Three-Phase - W22 "JM" Type - TEFC - High Efficiency

Catalog Number : 00536EP3H184JM-W22

List Price : \$>(discontinued)

Notes:

Downloaded from <http://dealerselectric.com>

Generated for Model #00536EP3H184JM-W22

Performed by:

Checked:



Dealers Industrial Equipment

No.:

Date: 13-SEP-2016

DATA SHEET Three-phase induction motor - Squirrel cage rotor

Customer :
 Product line : Close Coupled Pump: Three-Phase - W22 "JM" Type - TEFC - High Efficiency

Frame : 182/4JM
 Output : 5 HP
 Frequency : 60 Hz
 Poles : 2
 Full load speed : 3490 rpm
 Slip : 3.06 %
 Voltage : 575 V
 Rated current : 4.72 A
 Locked rotor current : 34.5 A
 Locked rotor current (I_L/I_n) : 7.3
 No-load current : 1.68 A
 Full load torque : 7.42 lb.ft
 Locked rotor torque : 200 %
 Breakdown torque : 300 %
 Design : B
 Insulation class : F
 Temperature rise : 80 K
 Locked rotor time : 27 s (hot)
 Service factor : 1.25
 Duty cycle : S1
 Ambient temperature : -20°C - +40°C
 Altitude : 1000 m
 Degree of Protection : IP55
 Approximate weight : 88 lb
 Moment of inertia : 0.19055 sq.ft.lb
 Noise level : 69 dB(A)

	D.E.	N.D.E.
Bearings	6307 ZZ	6206 ZZ
Regreasing interval	---	---
Grease amount	---	---

Load	Power factor	Efficiency (%)
100%	0.89	87.5
75%	0.86	87.5
50%	0.78	85.5

Notes:
 Downloaded from <http://dealerselectric.com>
 Generated for Model #00536EP3H184JM-W22

Performed by

Checked



Dealers Industrial Equipment

No.:

Date: 13-SEP-2016

PERFORMANCE CURVES RELATED TO RATED OUTPUT

Three-phase induction motor - Squirrel cage rotor

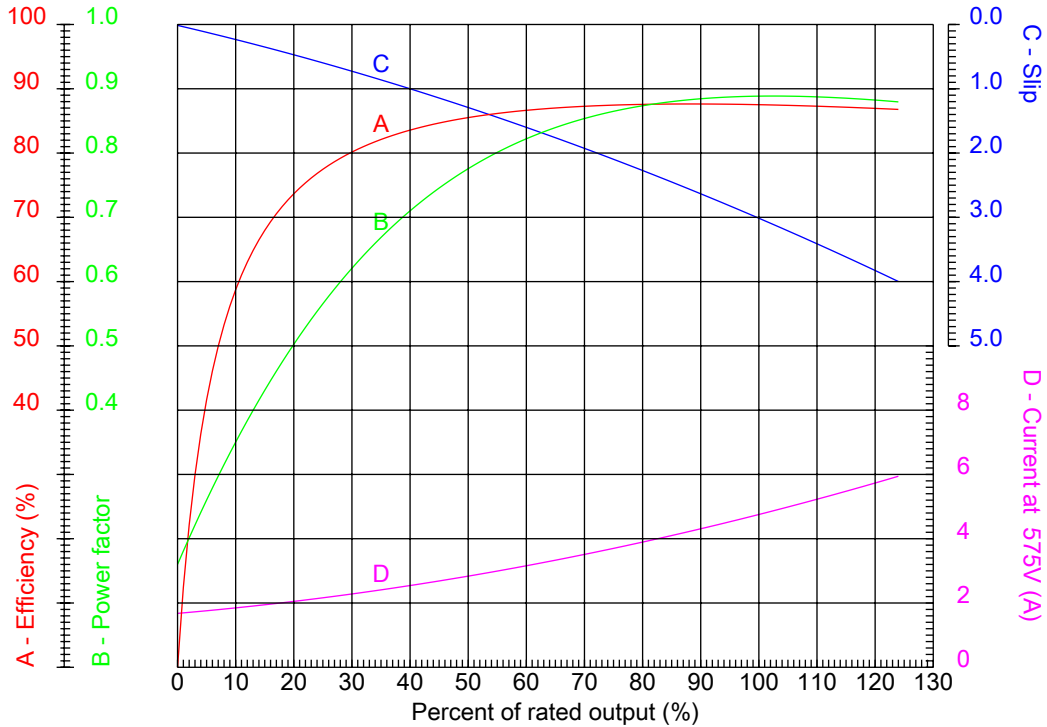

Customer :
 Product line : Close Coupled Pump: Three-Phase - W22 "JM" Type - TEFC - High Efficiency

Frame	: 182/4JM	Locked rotor current (I _l /I _n)	: 7.3
Output	: 5 HP	Duty cycle	: S1
Frequency	: 60 Hz	Service factor	: 1.25
Full load speed	: 3490 rpm	Design	: B
Voltage	: 575 V	Locked rotor torque	: 200 %
Rated current	: 4.72 A	Breakdown torque	: 300 %
Insulation class	: F		

Notes:
 Downloaded from <http://dealerselectric.com>
 Generated for Model #00536EP3H184JM-W22

Performed by

Checked



Dealers Industrial Equipment

No.:

Date: 13-SEP-2016

CHARACTERISTIC CURVES RELATED TO SPEED

Three-phase induction motor - Squirrel cage rotor

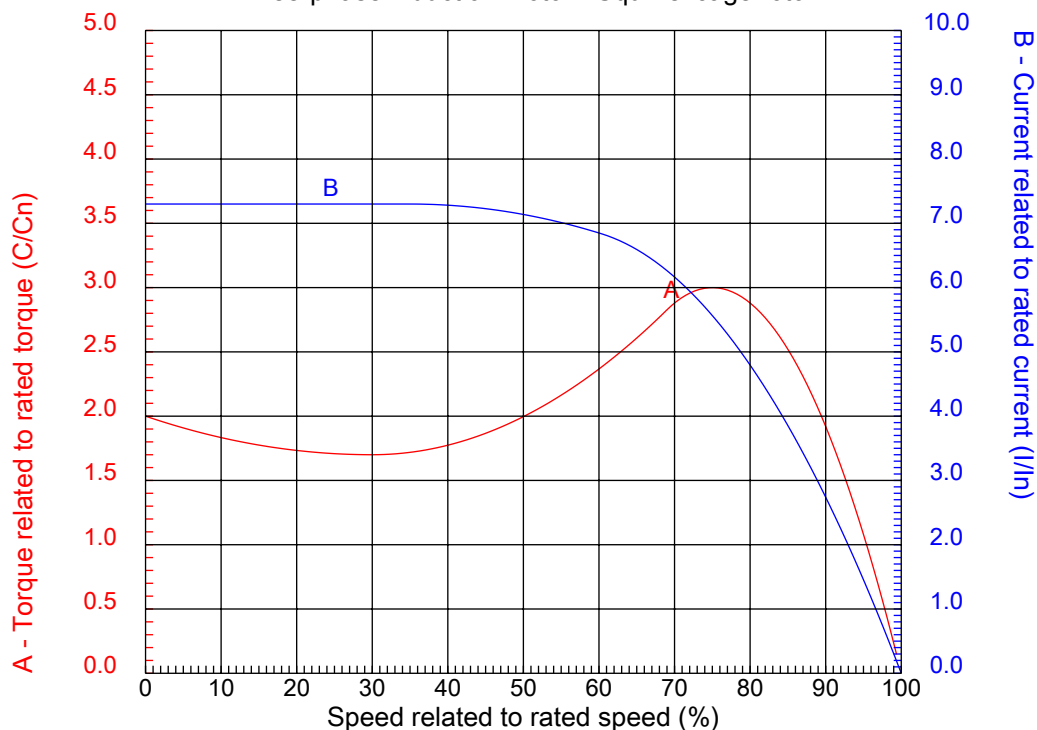

Customer :
Product line : Close Coupled Pump: Three-Phase - W22 "JM" Type - TEFC - High Efficiency

Frame	: 182/4JM	Locked rotor current (I _l /I _n)	: 7.3
Output	: 5 HP	Duty cycle	: S1
Frequency	: 60 Hz	Service factor	: 1.25
Full load speed	: 3490 rpm	Design	: B
Voltage	: 575 V	Locked rotor torque	: 200 %
Rated current	: 4.72 A	Breakdown torque	: 300 %
Insulation class	: F		

Notes:
Downloaded from <http://dealerselectric.com>
Generated for Model #00536EP3H184JM-W22

Performed by

Checked

1 2 3 4 5 6 7 8

A

B

C

D

E

F

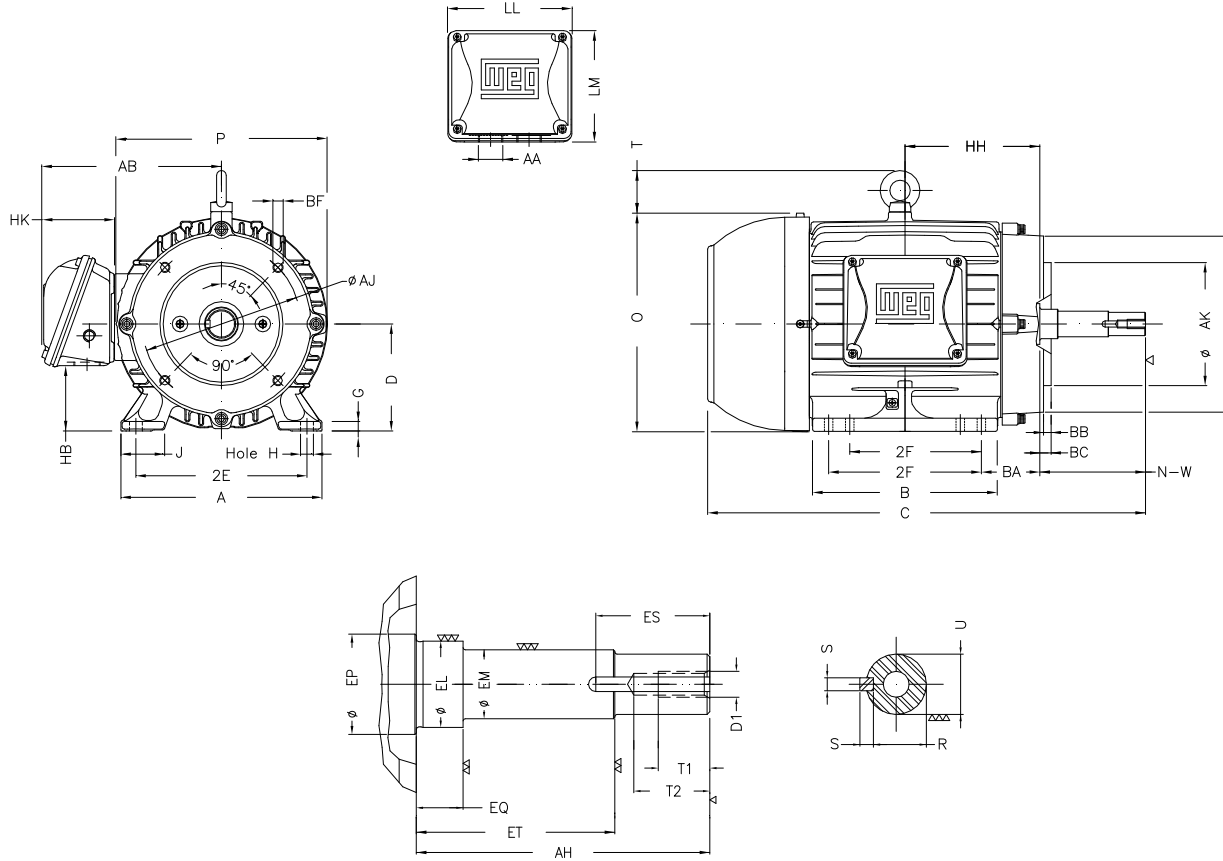

Notes: Downloaded from <http://dealerselectric.com>
Generated for Model #00536EP3H184JM-W22

Performed by:

Checked:

Customer:

Close Coupled Pump: Three-Phase - W22 "JM" Type - TEFC - High Efficiency

Three-phase induction motor
Frame 182/4JM - IP55

13-SEP-2016



2E 7.500	J 1.614	A 8.661	P 8.740	AB 7.565
2F 4.500/5.500	B 6.969	BA 2.750	D 4.500	G 0.394
O 9.343	T 1.772	H 0.406	AA NPT 1"	EQ 0.630
ET 2.880	U 0.874	EM 1.000	EL 1.250	EP 1.376
ES 1.575	t1 0.748	t2 1.102	C 17.411	d1 EUNC 3/8"-16
HH 5.500	HK 3.150	HB 2.236	LL 5.512	LM 5.236
S 0.187	R 0.768	Flange FC-149	AJ 5.874	AK 4.500
BD 6.496	BF UNC 3/8"x16	BB 0.157	AH 4.258	

1 2 3 4 5 6 7 8

A

B

C

D

E

F



Notes: Downloaded from <http://dealerselectric.com>
Generated for Model #00536EP3H184JM-W22

Performed by:

Checked:

Customer:

Close Coupled Pump: Three-Phase - W22 "JM" Type - TEFC - High Efficiency

Three-phase induction motor
Frame 182/4JM - IP55

13-SEP-2016

