



Dealers Industrial Equipment

No.:

Date: 13-SEP-2016

Customer :

TECHNICAL PROPOSAL

Three-phase induction motor - Squirrel cage rotor

Product line : Brake Motors : Three-Phase - High Efficiency
Catalog Number : 00536EP3EBM184T
List Price : \$>(discontinued)

Notes:
Downloaded from <http://dealerselectric.com>
Generated for Model #00536EP3EBM184T

Performed by:

Checked:



Dealers Industrial Equipment

No.:

Date: 13-SEP-2016

DATA SHEET Three-phase induction motor - Squirrel cage rotor

Customer :
 Product line : Brake Motors : Three-Phase - High Efficiency

Frame : 184T
 Output : 5 HP
 Frequency : 60 Hz
 Poles : 2
 Full load speed : 3480 rpm
 Slip : 3.33 %
 Voltage : 230/460 V
 Rated current : 11.8/5.90 A
 Locked rotor current : 90.9/45.4 A
 Locked rotor current (I_L/I_n) : 7.7
 No-load current : 3.60/1.80 A
 Full load torque : 7.44 lb.ft
 Locked rotor torque : 230 %
 Breakdown torque : 330 %
 Design : B
 Insulation class : F
 Temperature rise : 80 K
 Locked rotor time : 23 s (hot)
 Service factor : 1.25
 Duty cycle : S1
 Ambient temperature : -20°C - +40°C
 Altitude : 1000 m
 Degree of Protection : IP55
 Approximate weight : 116 lb
 Moment of inertia : 0.19981 sq.ft.lb
 Noise level : 69 dB(A)

	D.E.	N.D.E.
Bearings	6307 ZZ	6206 ZZ
Regreasing interval	---	---
Grease amount	---	---

Load	Power factor	Efficiency (%)
100%	0.90	87.5
75%	0.86	86.5
50%	0.80	84.0

Notes:
 Downloaded from <http://dealerselectric.com>
 Generated for Model #00536EP3EBM184T

Performed by

Checked



Dealers Industrial Equipment

No.:

Date: 13-SEP-2016

PERFORMANCE CURVES RELATED TO RATED OUTPUT

Three-phase induction motor - Squirrel cage rotor

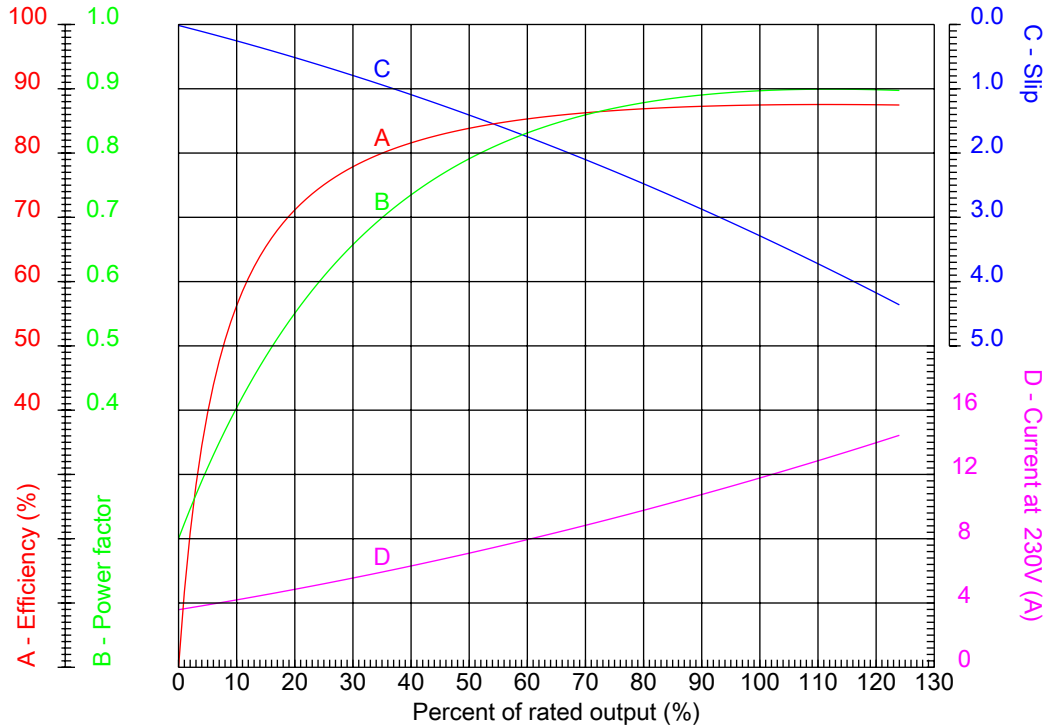

Customer :
 Product line : Brake Motors : Three-Phase - High Efficiency

Frame	: 184T	Locked rotor current (I _l /I _n)	: 7.7
Output	: 5 HP	Duty cycle	: S1
Frequency	: 60 Hz	Service factor	: 1.25
Full load speed	: 3480 rpm	Design	: B
Voltage	: 230/460 V	Locked rotor torque	: 230 %
Rated current	: 11.8/5.90 A	Breakdown torque	: 330 %
Insulation class	: F		

Notes:
 Downloaded from <http://dealerselectric.com>
 Generated for Model #00536EP3EBM184T

Performed by

Checked



Dealers Industrial Equipment

No.:

Date: 13-SEP-2016

CHARACTERISTIC CURVES RELATED TO SPEED

Three-phase induction motor - Squirrel cage rotor

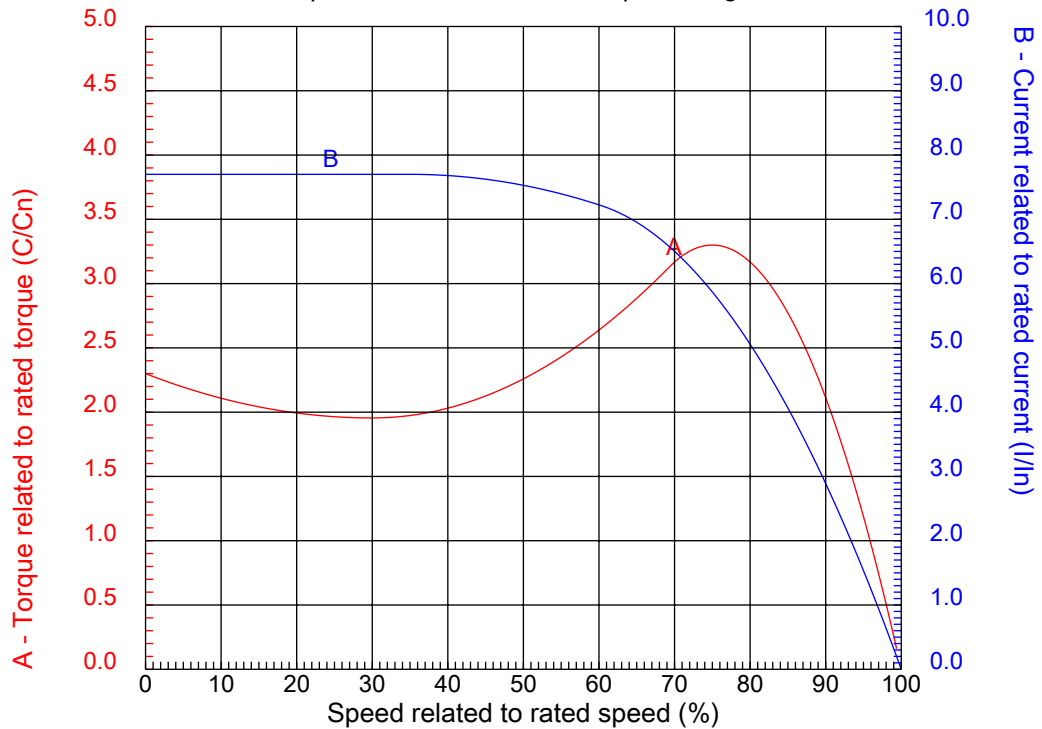

Customer :
Product line : Brake Motors : Three-Phase - High Efficiency

Frame	: 184T	Locked rotor current (I _l /I _n)	: 7.7
Output	: 5 HP	Duty cycle	: S1
Frequency	: 60 Hz	Service factor	: 1.25
Full load speed	: 3480 rpm	Design	: B
Voltage	: 230/460 V	Locked rotor torque	: 230 %
Rated current	: 11.8/5.90 A	Breakdown torque	: 330 %
Insulation class	: F		

Notes:
Downloaded from <http://dealerselectric.com>
Generated for Model #00536EP3EBM184T

Performed by

Checked

1 2 3 4 5 6 7 8

A

B

C

D

E

F

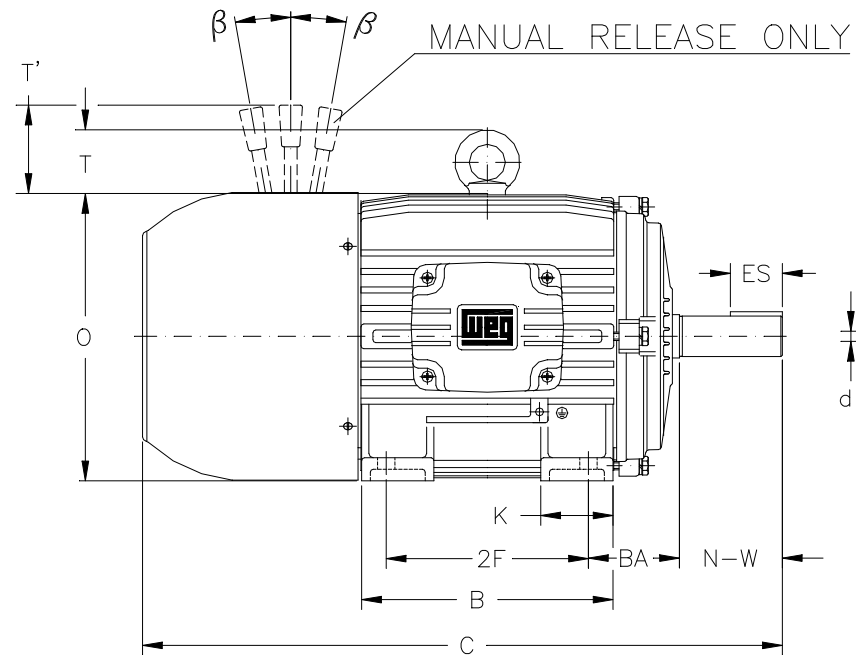
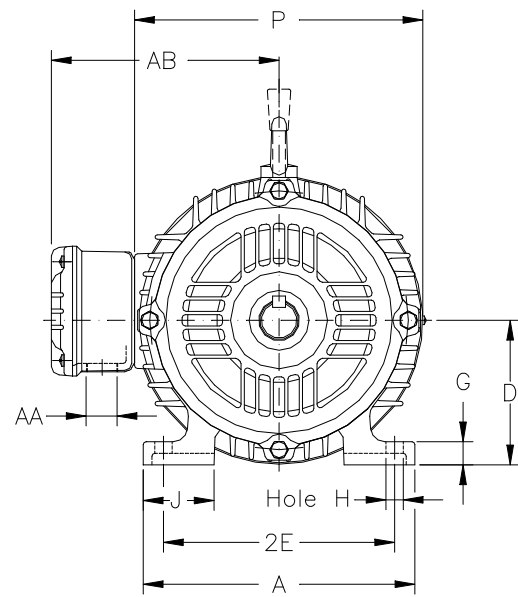

Notes: Downloaded from <http://dealerselectric.com>
Generated for Model #00536EP3EBM184T

Performed by:

Checked:

Customer:

Brake Motors : Three-Phase - High Efficiency

Three-phase induction motor
Frame 184T - IP55

13-SEP-2016



2E 7.500	A 8.661	2F 5.500	B 6.969	BA 2.750
J 1.890	K 1.969	P 8.740	ES 1.969	depth 0.250
S 0.250	N-W 2.750	U 1.125	R 0.984	AB 7.047
D 4.500	G 0.799	O 9.343	T 1.772	H 0.406
C 19.246	AA NPT 1"	d1 A 4	d2 A 4	

1 2 3 4 5 6 7 8

LOW VOLTAGE

HIGH VOLTAGE

A
B
C
D
E
F

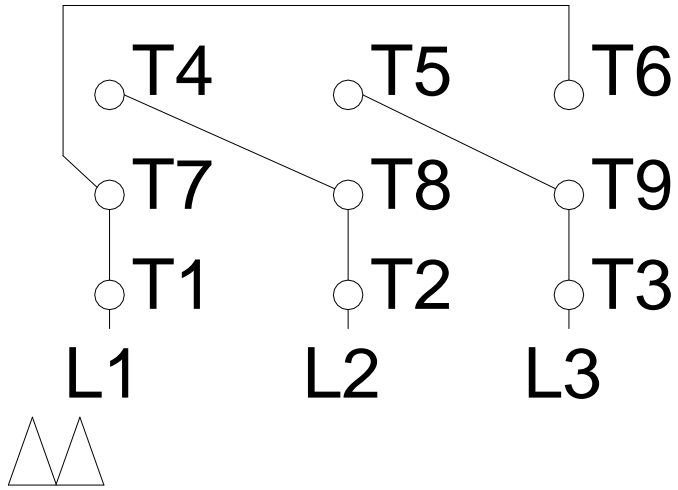

Notes: Downloaded from http://dealerselectric.com Generated for Model #00536EP3EBM184T		
Performed by:		
Checked:		
Customer:		
Brake Motors : Three-Phase - High Efficiency		
Three-phase induction motor Frame 184T - IP55	13-SEP-2016	