



Dealers Industrial Equipment

No.:

Date: 13-SEP-2016

Customer :

TECHNICAL PROPOSAL

Three-phase induction motor - Squirrel cage rotor

Product line : W01 (Rolled Steel) Close Coupled Pump TEFC - JM Type

Catalog Number : 00518ET3E184JM-SG

List Price : \$1,331

Notes:

Downloaded from <http://dealerselectric.com>

Generated for Model #00518ET3E184JM-SG

Performed by:

Checked:



Dealers Industrial Equipment

No.:

Date: 13-SEP-2016

DATA SHEET Three-phase induction motor - Squirrel cage rotor

Customer :
Product line : W01 (Rolled Steel) Close Coupled Pump TEFC - JM Type

Frame : 182/4JM
Output : 5 HP
Frequency : 60 Hz
Poles : 4
Full load speed : 1750 rpm
Slip : 2.78 %
Voltage : 208-230/460 V
Rated current : 14.4-13.0/6.49 A
Locked rotor current : 90.9/45.4 A
Locked rotor current (I_L/I_n) : 7.0
No-load current : 6.89/3.44 A
Full load torque : 14.8 lb.ft
Locked rotor torque : 220 %
Breakdown torque : 300 %
Design : B
Insulation class : F
Temperature rise : 80 K
Locked rotor time : 16 s (hot)
Service factor : 1.15
Duty cycle : S1
Ambient temperature : -20°C - +40°C
Altitude : 1000 m
Degree of Protection : IP55
Approximate weight : 71 lb
Moment of inertia : 0.30802 sq.ft.lb
Noise level : 56 dB(A)

	D.E.	N.D.E.
Bearings	6207 ZZ	6205 ZZ
Regreasing interval	---	---
Grease amount	---	---

Load	Power factor	Efficiency (%)
100%	0.80	89.5
75%	0.73	89.5
50%	0.60	88.5

Notes:
Downloaded from <http://dealerselectric.com>
Generated for Model #00518ET3E184JM-SG

Performed by

Checked



Dealers Industrial Equipment

No.:

Date: 13-SEP-2016

PERFORMANCE CURVES RELATED TO RATED OUTPUT

Three-phase induction motor - Squirrel cage rotor

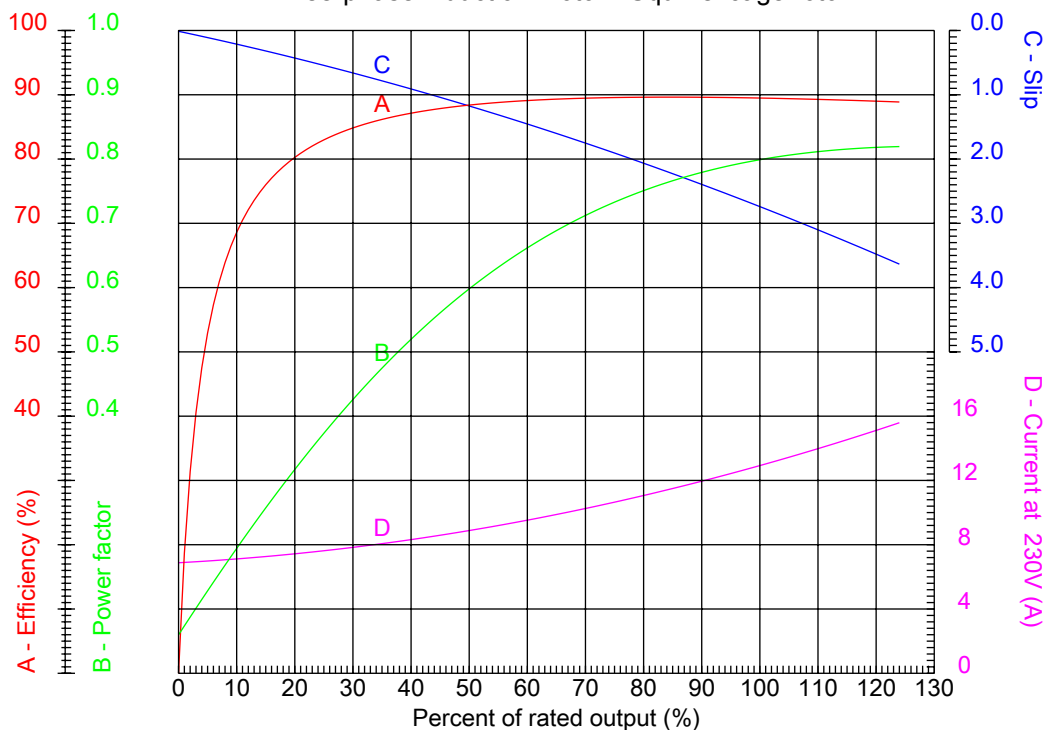

Customer :
Product line : W01 (Rolled Steel) Close Coupled Pump TEFC - JM Type

Frame	: 182/4JM	Locked rotor current (I _l /I _n)	: 7.0
Output	: 5 HP	Duty cycle	: S1
Frequency	: 60 Hz	Service factor	: 1.15
Full load speed	: 1750 rpm	Design	: B
Voltage	: 208-230/460 V	Locked rotor torque	: 220 %
Rated current	: 14.4-13.0/6.49 A	Breakdown torque	: 300 %
Insulation class	: F		

Notes:
Downloaded from <http://dealerselectric.com>
Generated for Model #00518ET3E184JM-SG

Performed by

Checked



Dealers Industrial Equipment

No.:

Date: 13-SEP-2016

CHARACTERISTIC CURVES RELATED TO SPEED

Three-phase induction motor - Squirrel cage rotor

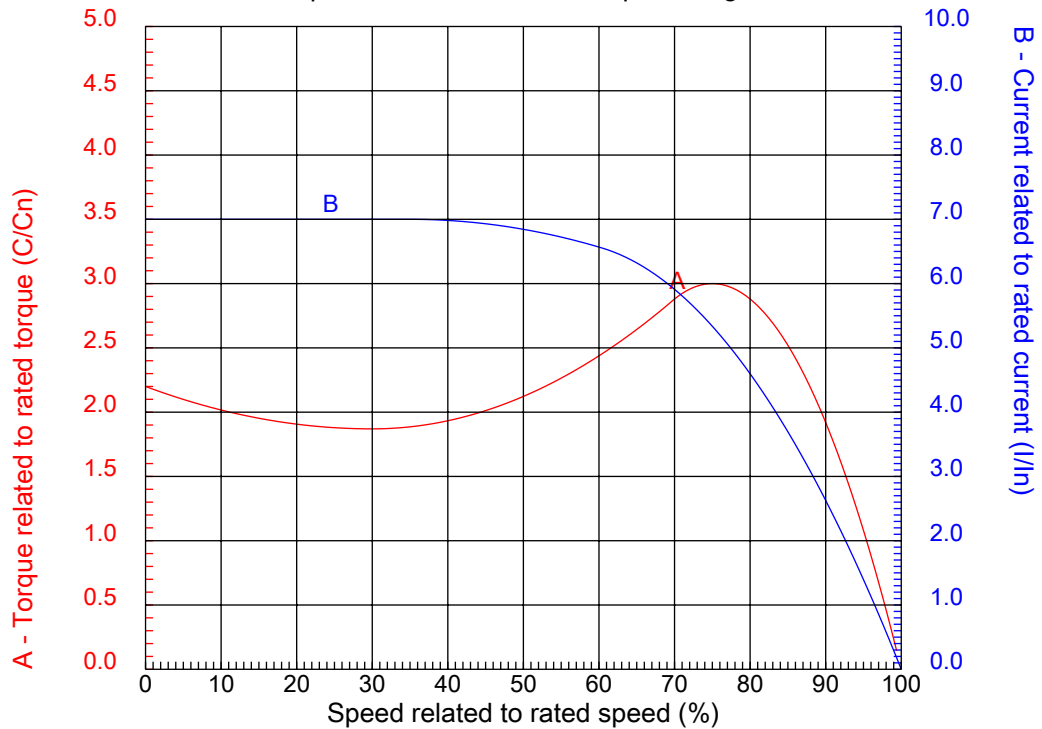

Customer :
Product line : W01 (Rolled Steel) Close Coupled Pump TEFC - JM Type

Frame	: 182/4JM	Locked rotor current (I _l /I _n)	: 7.0
Output	: 5 HP	Duty cycle	: S1
Frequency	: 60 Hz	Service factor	: 1.15
Full load speed	: 1750 rpm	Design	: B
Voltage	: 208-230/460 V	Locked rotor torque	: 220 %
Rated current	: 14.4-13.0/6.49 A	Breakdown torque	: 300 %
Insulation class	: F		

Notes:
Downloaded from <http://dealerselectric.com>
Generated for Model #00518ET3E184JM-SG

Performed by

Checked

1 2 3 4 5 6 7 8

A

B

C

D

E

F

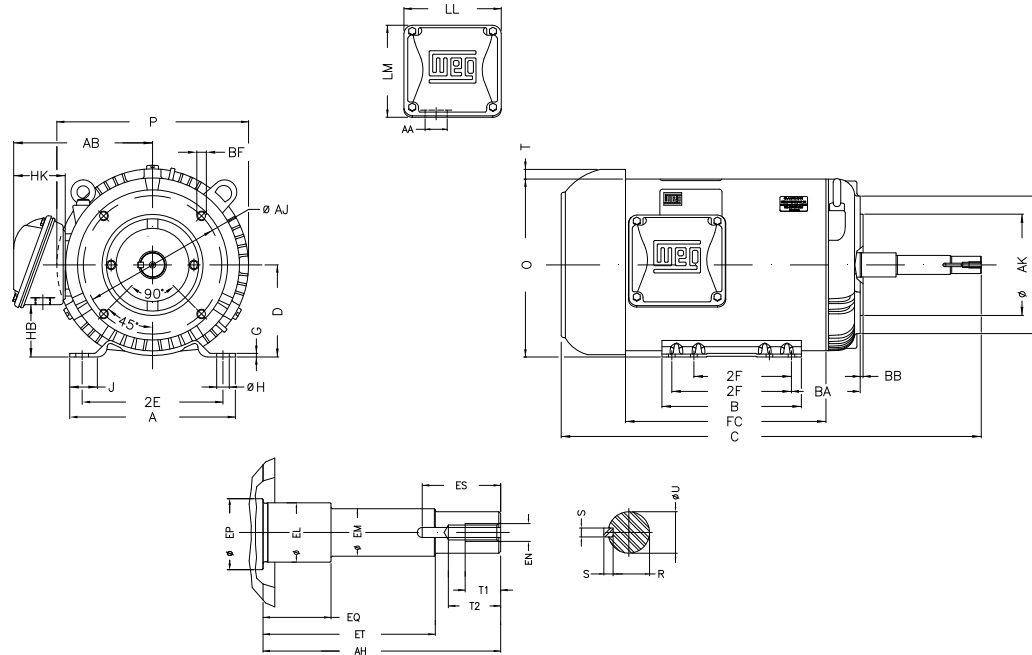

Notes: Downloaded from <http://dealerselectric.com>
Generated for Model #00518ET3E184JM-SG

2E 7.500	J 1.299	A 8.661	P 9.435	AB 6.696
2F 4.500/5.500	B 6.299	BA 3.500	D 4.500	G 0.167
O 8.557	T 0.661	H 0.406	AA 1.118"	ER 4.258
EQ 0.630	ET 2.880	U 0.8745	EM 1.000	EL 1.250
EP 1.376	ES 1.575	t1 0.748	t2 1.102	C 19.409
CH 1.377	FC 10.236	Flange FC-149	AJ 5.874	AK 4.500
BD 6.496	BF UNC 3/8"x16	BB 0.157	AH 4.258	

Performed by:	
Checked:	
Customer:	W01 (Rolled Steel) Close Coupled Pump TEFC - JM Type
Three-phase induction motor Frame 182/4JM - IP55	13-SEP-2016



1 2 3 4 5 6 7 8

LOW VOLTAGE

HIGH VOLTAGE

A
B
C
D
E
F

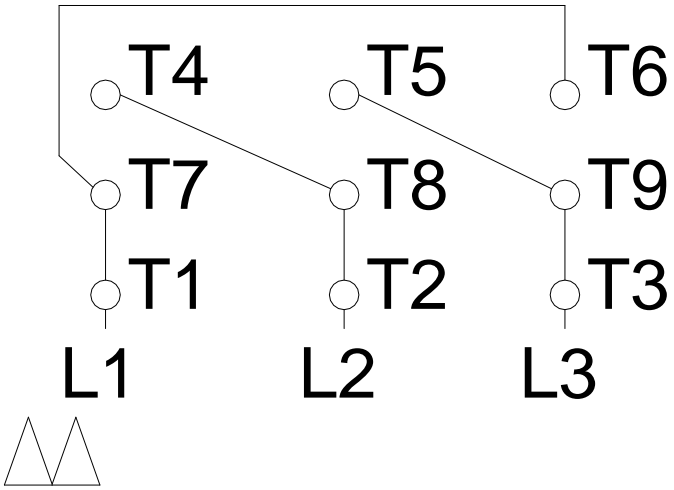

Notes: Downloaded from http://dealerselectric.com Generated for Model #00518ET3E184JM-SG		
Performed by:		
Checked:		
Customer:		
W01 (Rolled Steel) Close Coupled Pump TEFC - JM Type		
Three-phase induction motor Frame 182/4JM - IP55	13-SEP-2016	