



Dealers Industrial Equipment

No.:

Date: 13-SEP-2016

Customer :

TECHNICAL PROPOSAL

Three-phase induction motor - Squirrel cage rotor

Product line : Three Phase: W01 (Rolled Steel) - TEFC - High Efficiency

Catalog Number : 00518EP3ER184TC-S

List Price : \$>(discontinued)

Notes:

Downloaded from <http://dealerselectric.com>

Generated for Model #00518EP3ER184TC-S

Performed by:

Checked:



Dealers Industrial Equipment

No.:

Date: 13-SEP-2016

DATA SHEET Three-phase induction motor - Squirrel cage rotor

Customer :
 Product line : Three Phase: W01 (Rolled Steel) - TEFC - High Efficiency

Frame : 182/4T
 Output : 5 HP
 Frequency : 60 Hz
 Poles : 4
 Full load speed : 1750 rpm
 Slip : 2.78 %
 Voltage : 208-230/460 V
 Rated current : 14.5-13.1/6.55 A
 Locked rotor current : 94.3/47.2 A
 Locked rotor current (I_L/I_n) : 7.2
 No-load current : 6.93/3.47 A
 Full load torque : 14.8 lb.ft
 Locked rotor torque : 200 %
 Breakdown torque : 300 %
 Design : B
 Insulation class : F
 Temperature rise : 80 K
 Locked rotor time : 8 s (hot)
 Service factor : 1.15
 Duty cycle : S1
 Ambient temperature : -20°C - +40°C
 Altitude : 1000 m
 Degree of Protection : IP55
 Approximate weight : 77 lb
 Moment of inertia : 0.36948 sq.ft.lb
 Noise level : 56 dB(A)

	D.E.	N.D.E.
Bearings	6206 ZZ	6205 ZZ
Regreasing interval	---	---
Grease amount	---	---

Load	Power factor	Efficiency (%)
100%	0.81	87.5
75%	0.74	87.5
50%	0.61	86.5

Notes:
 Downloaded from <http://dealerselectric.com>
 Generated for Model #00518EP3ER184TC-S

Performed by

Checked



Dealers Industrial Equipment

No.:

Date: 13-SEP-2016

PERFORMANCE CURVES RELATED TO RATED OUTPUT

Three-phase induction motor - Squirrel cage rotor

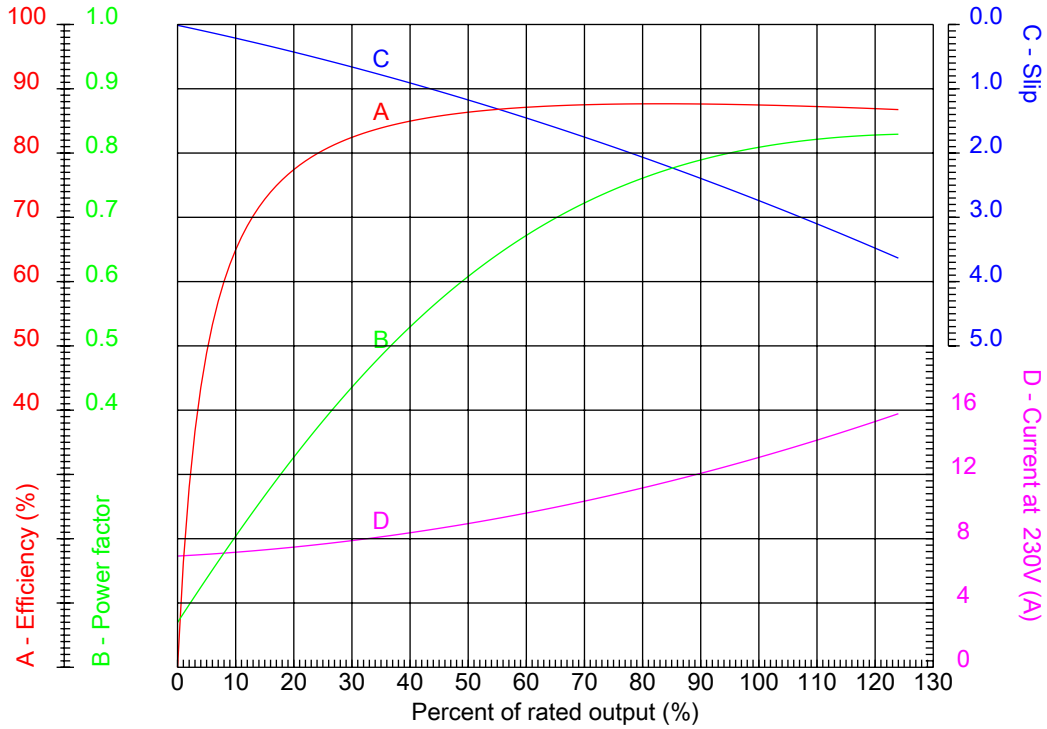

Customer :
 Product line : Three Phase: W01 (Rolled Steel) - TEFC - High Efficiency

Frame	: 182/4T	Locked rotor current (I _l /I _n)	: 7.2
Output	: 5 HP	Duty cycle	: S1
Frequency	: 60 Hz	Service factor	: 1.15
Full load speed	: 1750 rpm	Design	: B
Voltage	: 208-230/460 V	Locked rotor torque	: 200 %
Rated current	: 14.5-13.1/6.55 A	Breakdown torque	: 300 %
Insulation class	: F		

Notes:
 Downloaded from <http://dealerselectric.com>
 Generated for Model #00518EP3ER184TC-S

Performed by

Checked



Dealers Industrial Equipment

No.:

Date: 13-SEP-2016

CHARACTERISTIC CURVES RELATED TO SPEED

Three-phase induction motor - Squirrel cage rotor

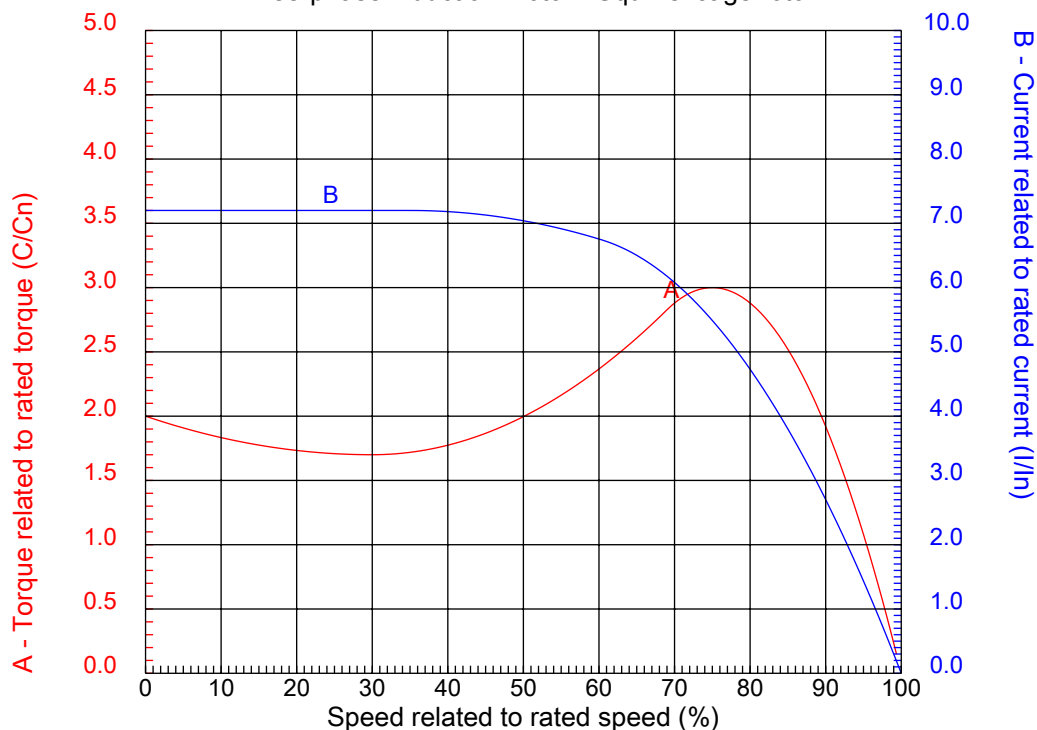

Customer :
Product line : Three Phase: W01 (Rolled Steel) - TEFC - High Efficiency

Frame	: 182/4T	Locked rotor current (I _l /I _n)	: 7.2
Output	: 5 HP	Duty cycle	: S1
Frequency	: 60 Hz	Service factor	: 1.15
Full load speed	: 1750 rpm	Design	: B
Voltage	: 208-230/460 V	Locked rotor torque	: 200 %
Rated current	: 14.5-13.1/6.55 A	Breakdown torque	: 300 %
Insulation class	: F		

Notes:
Downloaded from <http://dealerselectric.com>
Generated for Model #00518EP3ER184TC-S

Performed by

Checked

1 2 3 4 5 6 7 8

A

B

C

D

E

F

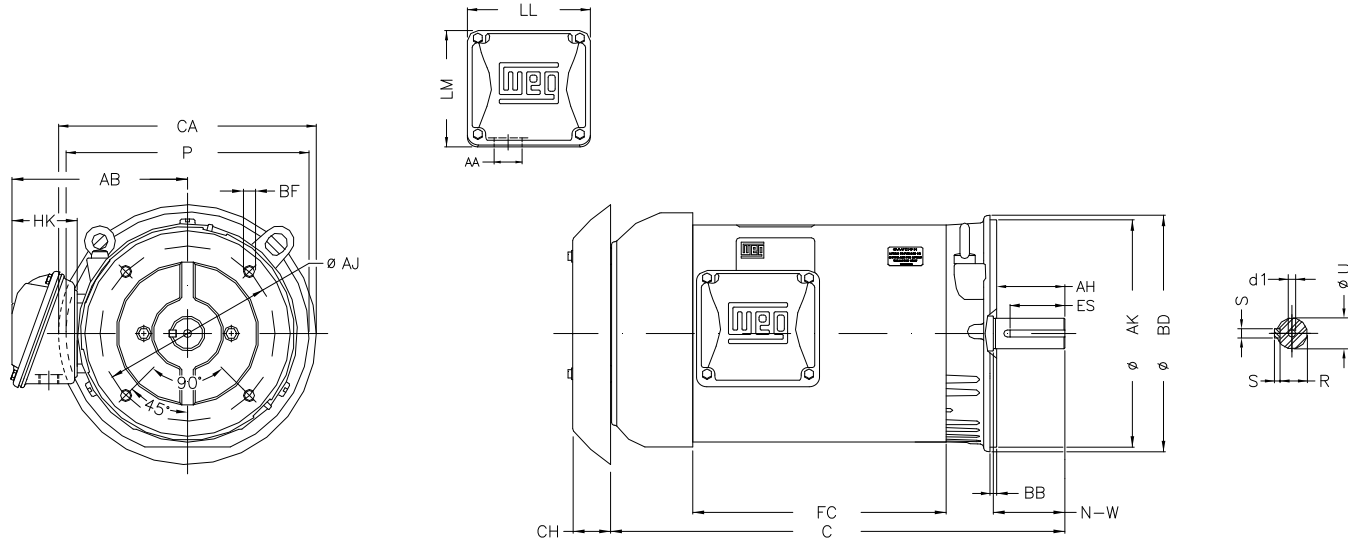

Notes: Downloaded from <http://dealerselectric.com>
Generated for Model #00518EP3ER184TC-S

Performed by:

Checked:

Customer:

Three Phase: W01 (Rolled Steel) - TEFC - High Efficiency

Three-phase induction motor
Frame 182/4T - IP55

13-SEP-2016



P 9.435	AB 6.696	HK 2.629	FC 10.236	C 17.913
N-W 2.750	ES 1.969	d1 A 3.15	S 0.250	U 1.125
AA 1.118"	depth 0.250	R 0.984	LL 4.563	LM 4.090
CH 1.377	Flange FC-184	AJ 7.250	AK 8.500	BD 8.846
BF UNC 1/2"x13	BB 0.250	AH 2.620		

1 2 3 4 5 6 7 8

LOW VOLTAGE

HIGH VOLTAGE

A
B
C
D
E
F



Notes: Downloaded from http://dealerselectric.com Generated for Model #00518EP3ER184TC-S		
Performed by:		
Checked:		
Customer:		
Three Phase: W01 (Rolled Steel) - TEFC - High Efficiency		
Three-phase induction motor Frame 182/4T - IP55	13-SEP-2016	