



Dealers Industrial Equipment

No.:

Date: 12-SEP-2016

Customer :

TECHNICAL PROPOSAL

Three-phase induction motor - Squirrel cage rotor

Product line : Close Coupled Pump: Three-Phase - W22 "JM" Type - TEFC - High Efficiency

Catalog Number : 00336EP3E182JM-W22

List Price : \$>(discontinued)

Notes:

Downloaded from <http://dealerselectric.com>

Generated for Model #00336EP3E182JM-W22

Performed by:

Checked:



Dealers Industrial Equipment

No.:

Date: 12-SEP-2016

DATA SHEET Three-phase induction motor - Squirrel cage rotor

Customer :
 Product line : Close Coupled Pump: Three-Phase - W22 "JM" Type - TEFC - High Efficiency

Frame : 182JM
 Output : 3 HP
 Frequency : 60 Hz
 Poles : 2
 Full load speed : 3500 rpm
 Slip : 2.78 %
 Voltage : 230/460 V
 Rated current : 7.34/3.67 A
 Locked rotor current : 52.8/26.4 A
 Locked rotor current (I_L/I_n) : 7.2
 No-load current : 2.60/1.30 A
 Full load torque : 4.44 lb.ft
 Locked rotor torque : 200 %
 Breakdown torque : 310 %
 Design : B
 Insulation class : F
 Temperature rise : 80 K
 Locked rotor time : 28 s (hot)
 Service factor : 1.25
 Duty cycle : S1
 Ambient temperature : -20°C - +40°C
 Altitude : 1000 m
 Degree of Protection : IP55
 Approximate weight : 85 lb
 Moment of inertia : 0.16445 sq.ft.lb
 Noise level : 69 dB(A)

	D.E.	N.D.E.
Bearings	6307 ZZ	6206 ZZ
Regreasing interval	---	---
Grease amount	---	---

Load	Power factor	Efficiency (%)
100%	0.88	85.5
75%	0.84	85.5
50%	0.76	82.5

Notes:
 Downloaded from <http://dealerselectric.com>
 Generated for Model #00336EP3E182JM-W22

Performed by

Checked



Dealers Industrial Equipment

No.:

Date: 12-SEP-2016

PERFORMANCE CURVES RELATED TO RATED OUTPUT

Three-phase induction motor - Squirrel cage rotor

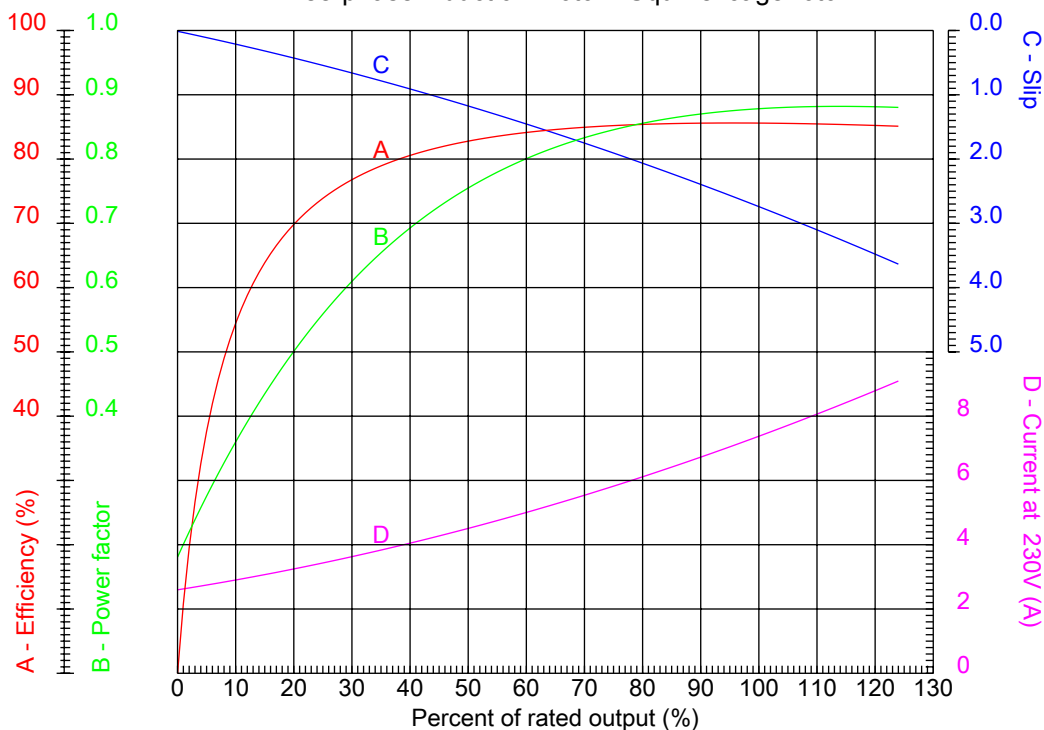

Customer :
 Product line : Close Coupled Pump: Three-Phase - W22 "JM" Type - TEFC - High Efficiency

Frame	: 182JM	Locked rotor current (I _l /I _n)	: 7.2
Output	: 3 HP	Duty cycle	: S1
Frequency	: 60 Hz	Service factor	: 1.25
Full load speed	: 3500 rpm	Design	: B
Voltage	: 230/460 V	Locked rotor torque	: 200 %
Rated current	: 7.34/3.67 A	Breakdown torque	: 310 %
Insulation class	: F		

Notes:
 Downloaded from <http://dealerselectric.com>
 Generated for Model #00336EP3E182JM-W22

Performed by

Checked



Dealers Industrial Equipment

No.:

Date: 12-SEP-2016

CHARACTERISTIC CURVES RELATED TO SPEED

Three-phase induction motor - Squirrel cage rotor

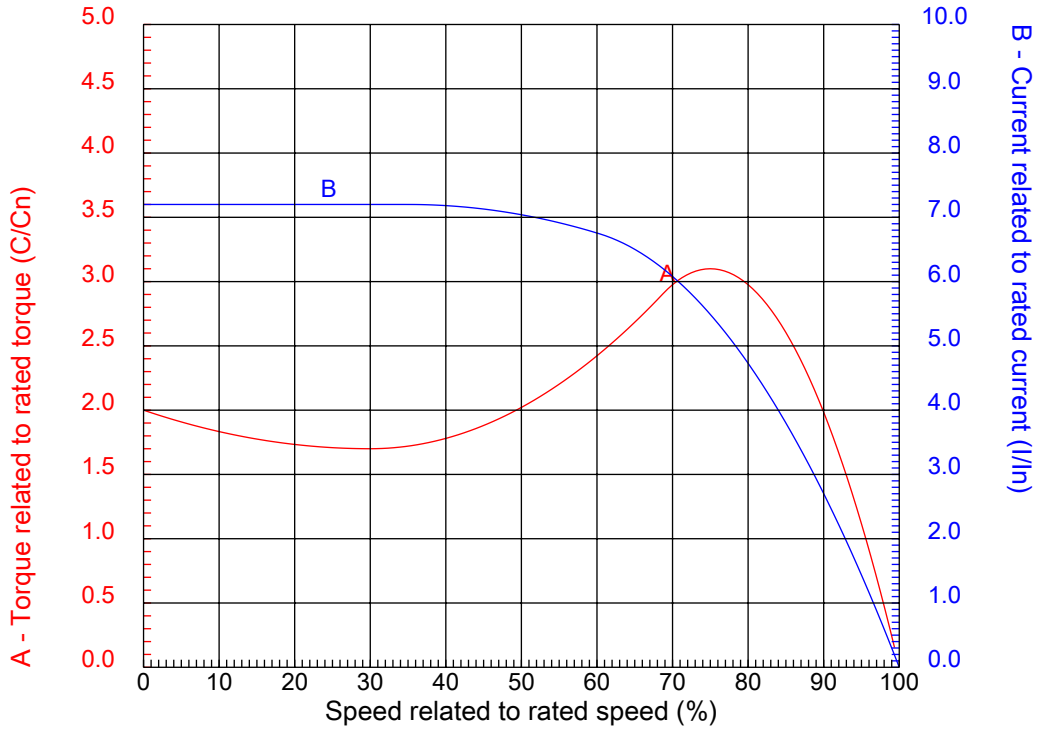

Customer :
 Product line : Close Coupled Pump: Three-Phase - W22 "JM" Type - TEFC - High Efficiency

Frame	: 182JM	Locked rotor current (I _l /I _n)	: 7.2
Output	: 3 HP	Duty cycle	: S1
Frequency	: 60 Hz	Service factor	: 1.25
Full load speed	: 3500 rpm	Design	: B
Voltage	: 230/460 V	Locked rotor torque	: 200 %
Rated current	: 7.34/3.67 A	Breakdown torque	: 310 %
Insulation class	: F		

Notes:
 Downloaded from <http://dealerselectric.com>
 Generated for Model #00336EP3E182JM-W22

Performed by

Checked

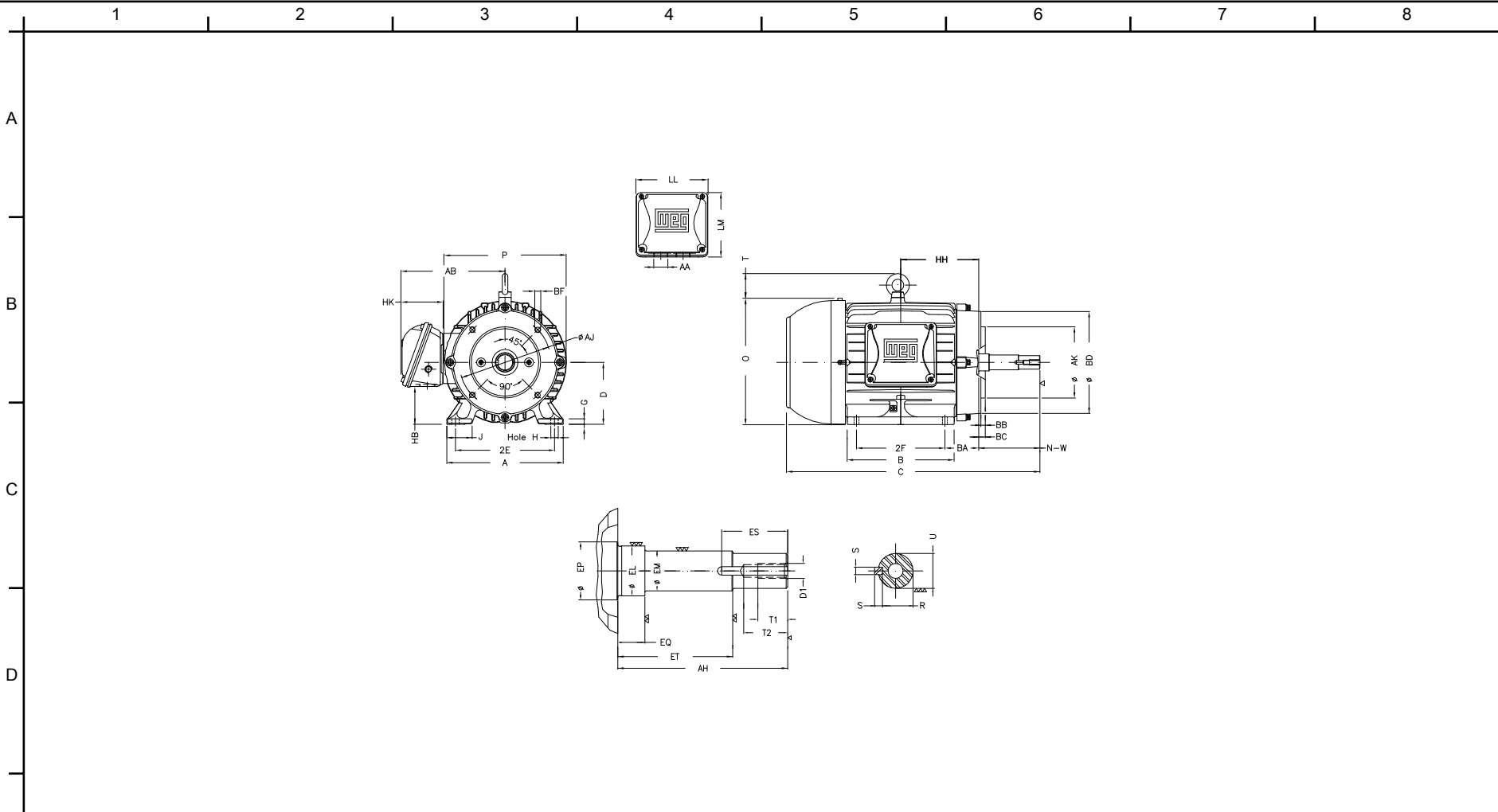

Notes: Downloaded from <http://dealerselectric.com>
 Generated for Model #00336EP3E182JM-W22

2E	J	A	P	AB
7.500	1.614	8.661	8.740	7.565
2F	B	BA	D	G
4.500	5.945	2.750	4.500	0.394
O	T	H	AA	EQ
9.343	1.772	0.406	NPT 1"	0.630
ET	U	EM	EL	EP
2.880	0.874	1.000	1.250	1.376
ES	t1	t2	C	d1
1.575	0.748	1.102	16.412	EUNC 3/8"-16
HH	HK	HB	LL	LM
5.000	3.150	2.236	5.512	5.236
S	R	Flange	AJ	AK
0.187	0.768	FC-149	5.874	4.500
BD	BF	BB	AH	
6.496	UNC 3/8"x16	0.157	4.258	

Performed by:

Checked:

Customer:

Close Coupled Pump: Three-Phase - W22 "JM" Type - TEFC - High Efficiency

Three-phase induction motor
 Frame 182JM - IP55

12-SEP-2016



1 2 3 4 5 6 7 8

LOW VOLTAGE

HIGH VOLTAGE

A
B
C
D
E
F

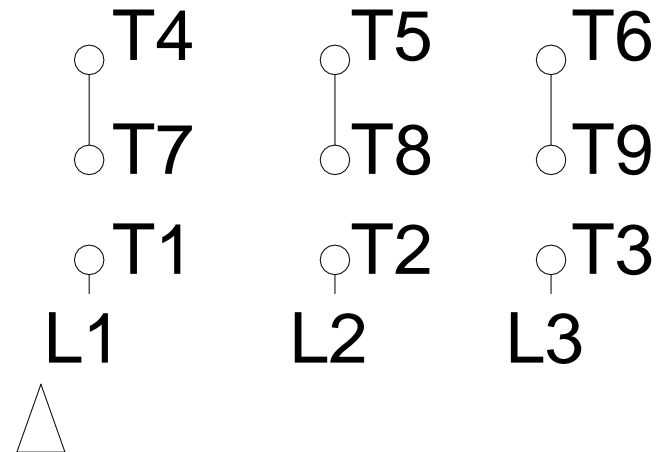

Notes: Downloaded from <http://dealerselectric.com>
 Generated for Model #00336EP3E182JM-W22

Performed by:

Checked:

Customer:

Close Coupled Pump: Three-Phase - W22 "JM" Type - TEFC - High Efficiency

Three-phase induction motor
 Frame 182JM - IP55

12-SEP-2016

