



Dealers Industrial Equipment

No.:

Date: 12-SEP-2016

Customer :

TECHNICAL PROPOSAL

Three-phase induction motor - Squirrel cage rotor

Product line : ODP – Open Induction Motors – NEMA Premium Efficiency

Catalog Number : 00318OT3H182T

List Price : \$524

Notes:

Downloaded from <http://dealerselectric.com>

Generated for Model #00318OT3H182T

Performed by:

Checked:



Dealers Industrial Equipment

No.:

Date: 12-SEP-2016

DATA SHEET Three-phase induction motor - Squirrel cage rotor

Customer :
 Product line : ODP – Open Induction Motors – NEMA Premium Efficiency

Frame : 182T
 Output : 3 HP
 Frequency : 60 Hz
 Poles : 4
 Full load speed : 1760 rpm
 Slip : 2.22 %
 Voltage : 575 V
 Rated current : 3.25 A
 Locked rotor current : 26.3 A
 Locked rotor current (I_L/I_n) : 8.1
 No-load current : 1.90 A
 Full load torque : 8.83 lb.ft
 Locked rotor torque : 240 %
 Breakdown torque : 300 %
 Design : B
 Insulation class : F
 Temperature rise : 80 K
 Locked rotor time : 12 s (hot)
 Service factor : 1.15
 Duty cycle : S1
 Ambient temperature : -20°C - +40°C
 Altitude : 1000 m
 Degree of Protection : IP21
 Approximate weight : 58 lb
 Moment of inertia : 0.25415 sq.ft.lb
 Noise level : ---

	D.E.	N.D.E.
Bearings	6206 ZZ	6205 ZZ
Regreasing interval	---	---
Grease amount	---	---

Load	Power factor	Efficiency (%)
100%	0.76	89.5
75%	0.68	88.5
50%	0.54	85.5

Notes:
 Downloaded from <http://dealerselectric.com>
 Generated for Model #00318OT3H182T

Performed by

Checked



Dealers Industrial Equipment

No.:

Date: 12-SEP-2016

PERFORMANCE CURVES RELATED TO RATED OUTPUT

Three-phase induction motor - Squirrel cage rotor

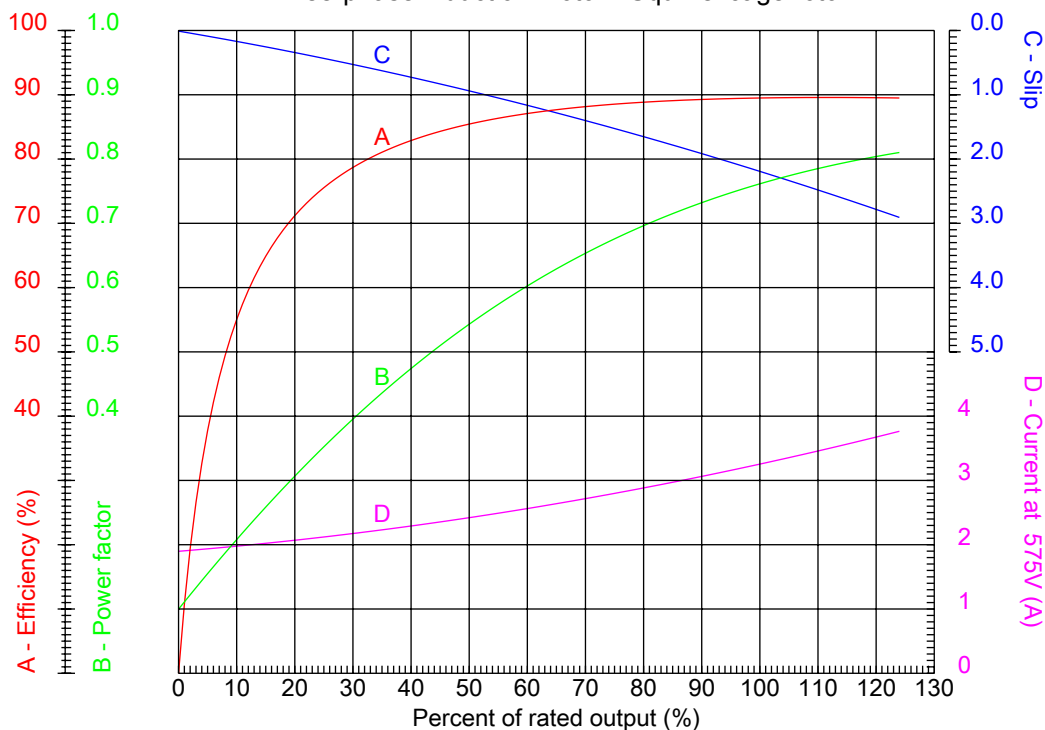

Customer :
 Product line : ODP – Open Induction Motors – NEMA Premium Efficiency

Frame : 182T	Locked rotor current (I _L /I _n) : 8.1
Output : 3 HP	Duty cycle : S1
Frequency : 60 Hz	Service factor : 1.15
Full load speed : 1760 rpm	Design : B
Voltage : 575 V	Locked rotor torque : 240 %
Rated current : 3.25 A	Breakdown torque : 300 %
Insulation class : F	

Notes:
 Downloaded from <http://dealerselectric.com>
 Generated for Model #00318OT3H182T

Performed by

Checked



Dealers Industrial Equipment

No.:

Date: 12-SEP-2016

CHARACTERISTIC CURVES RELATED TO SPEED

Three-phase induction motor - Squirrel cage rotor

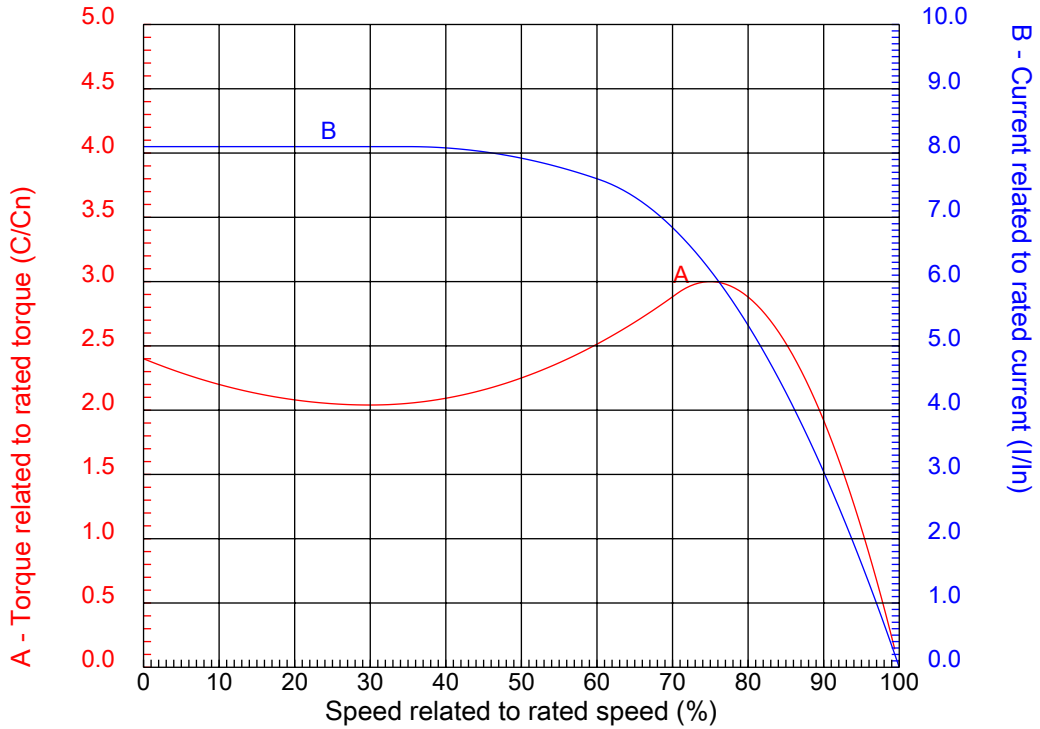

Customer :
 Product line : ODP – Open Induction Motors – NEMA Premium Efficiency

Frame	: 182T	Locked rotor current (I _l /I _n)	: 8.1
Output	: 3 HP	Duty cycle	: S1
Frequency	: 60 Hz	Service factor	: 1.15
Full load speed	: 1760 rpm	Design	: B
Voltage	: 575 V	Locked rotor torque	: 240 %
Rated current	: 3.25 A	Breakdown torque	: 300 %
Insulation class	: F		

Notes:
 Downloaded from <http://dealerselectric.com>
 Generated for Model #00318OT3H182T

Performed by

Checked

1 2 3 4 5 6 7 8

A

B

C

D

E

F

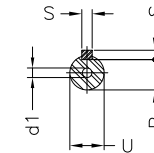
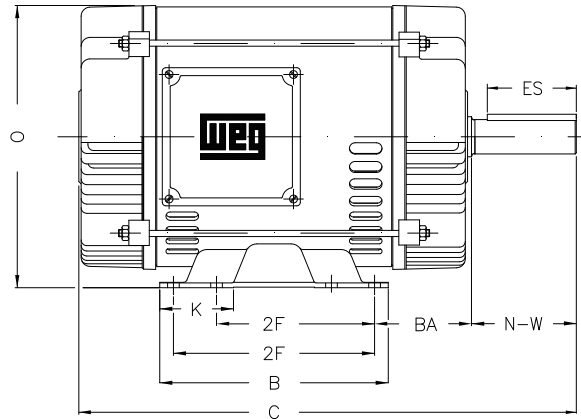
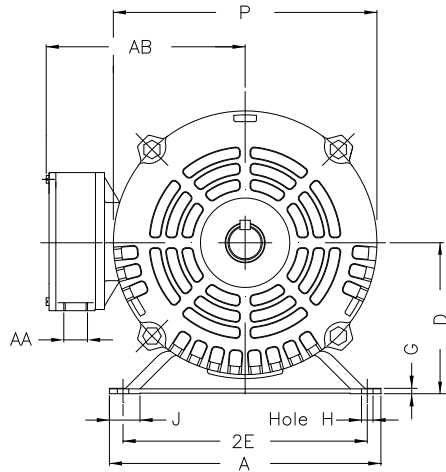

Notes: Downloaded from <http://dealerselectric.com>
Generated for Model #003180T3H182T

Performed by:

Checked:

Customer:

ODP – Open Induction Motors – NEMA Premium Efficiency

Three-phase induction motor
Frame 182T - IP21

12-SEP-2016



2E 7.500	J 1.171	A 8.661	P 7.637	AB 6.575
2F 4.500/5.500	K 1.988	B 6.299	BA 2.750	U 1.125
d1 A 4	N-W 2.750	ES 1.969	S 0.250	R 0.984
depth 0.250	D 4.500	G 0.187	O 8.307	H 0.406
C 13.504	AA NPT 3/4"			

1 2 3 4 5 6 7 8

A
B
C
D
E
F

RUN



ONLY FOR START



Notes: Downloaded from http://dealerselectric.com Generated for Model #00318OT3H182T		
Performed by:		
Checked:		
Customer:		
ODP – Open Induction Motors – NEMA Premium Efficiency		
Three-phase induction motor Frame 182T - IP21	12-SEP-2016	