



Dealers Industrial Equipment

No.:

Date: 12-SEP-2016

Customer :

TECHNICAL PROPOSAL

Three-phase induction motor - Squirrel cage rotor

Product line : Three Phase: W01 (Rolled Steel) - ODP - NEMA Premium Efficiency

Catalog Number : 00318OT3E182T-S

List Price : \$524

Notes:

Downloaded from <http://dealerselectric.com>

Generated for Model #00318OT3E182T-S

Performed by:

Checked:



Dealers Industrial Equipment

No.:

Date: 12-SEP-2016

DATA SHEET

Three-phase induction motor - Squirrel cage rotor

Customer :
 Product line : Three Phase: W01 (Rolled Steel) - ODP - NEMA Premium Efficiency

Frame : 182/4T
 Output : 3 HP
 Frequency : 60 Hz
 Poles : 4
 Full load speed : 1765 rpm
 Slip : 1.94 %
 Voltage : 208-230/460 V
 Rated current : 8.54-7.72/3.86 A
 Locked rotor current : 64.8/32.4 A
 Locked rotor current (I_L/I_n) : 8.4
 No-load current : 4.14/2.07 A
 Full load torque : 8.81 lb.ft
 Locked rotor torque : 220 %
 Breakdown torque : 330 %
 Design : B
 Insulation class : F
 Temperature rise : 80 K
 Locked rotor time : 15 s (hot)
 Service factor : 1.15
 Duty cycle : S1
 Ambient temperature : -20°C - +40°C
 Altitude : 1000 m
 Degree of Protection : ODP
 Approximate weight : 66 lb
 Moment of inertia : 0.30920 sq.ft.lb
 Noise level : 55 dB(A)

| | D.E. | N.D.E. |
|---------------------|---------|---------|
| Bearings | 6206 ZZ | 6205 ZZ |
| Regreasing interval | --- | --- |
| Grease amount | --- | --- |

| Load | Power factor | Efficiency (%) |
|------|--------------|----------------|
| 100% | 0.80 | 89.5 |
| 75% | 0.73 | 88.5 |
| 50% | 0.60 | 87.5 |

Notes:
 Downloaded from <http://dealerselectric.com>
 Generated for Model #003180T3E182T-S

Performed by

Checked



Dealers Industrial Equipment

No.:

Date: 12-SEP-2016

PERFORMANCE CURVES RELATED TO RATED OUTPUT

Three-phase induction motor - Squirrel cage rotor

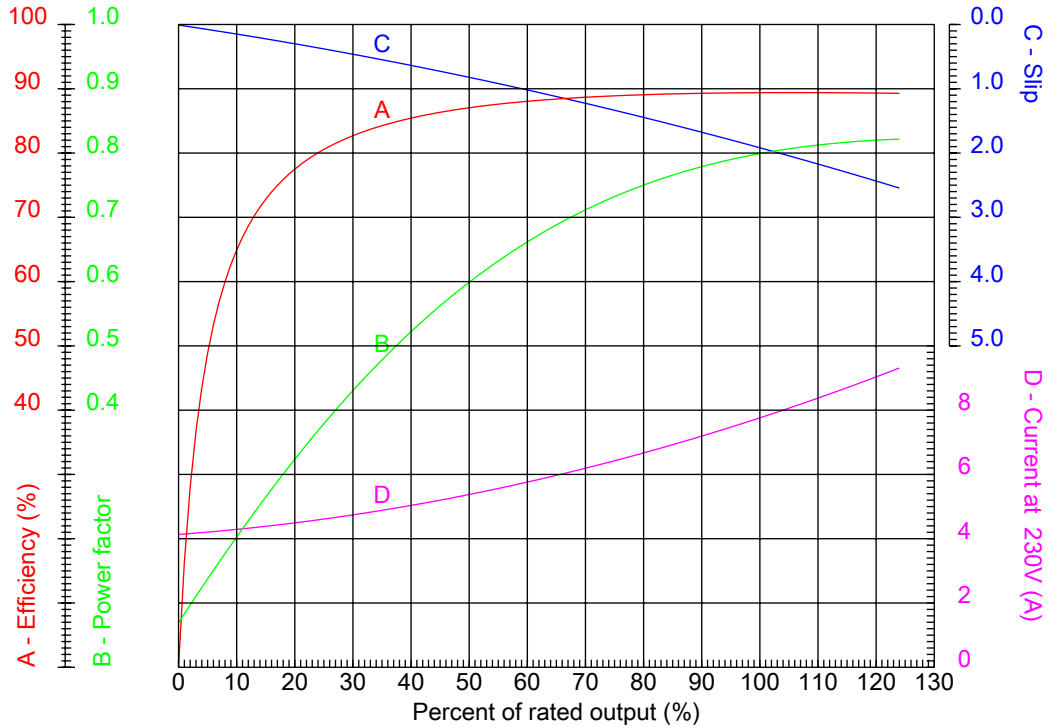

Customer :
Product line : Three Phase: W01 (Rolled Steel) - ODP - NEMA Premium Efficiency

| | | | |
|------------------|--------------------|--|---------|
| Frame | : 182/4T | Locked rotor current (I _l /I _n) | : 8.4 |
| Output | : 3 HP | Duty cycle | : S1 |
| Frequency | : 60 Hz | Service factor | : 1.15 |
| Full load speed | : 1765 rpm | Design | : B |
| Voltage | : 208-230/460 V | Locked rotor torque | : 220 % |
| Rated current | : 8.54-7.72/3.86 A | Breakdown torque | : 330 % |
| Insulation class | : F | | |

Notes:
Downloaded from <http://dealerselectric.com>
Generated for Model #00318OT3E182T-S

Performed by

Checked



Dealers Industrial Equipment

No.:

Date: 12-SEP-2016

CHARACTERISTIC CURVES RELATED TO SPEED

Three-phase induction motor - Squirrel cage rotor

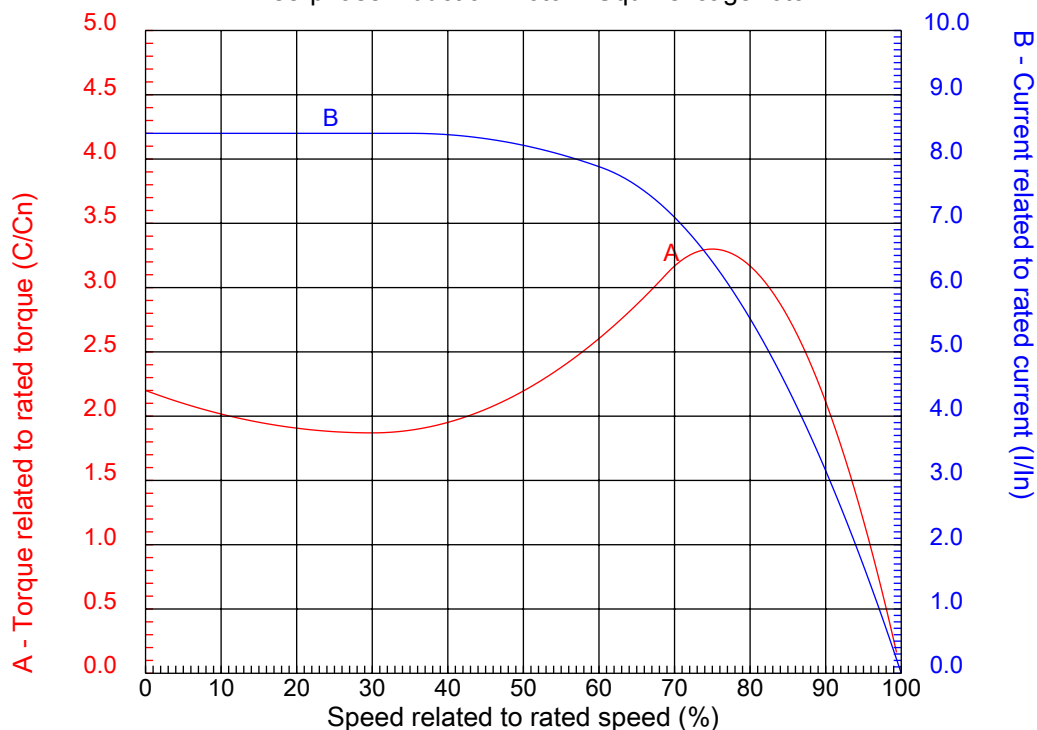

Customer :
Product line : Three Phase: W01 (Rolled Steel) - ODP - NEMA Premium Efficiency

| | | | |
|------------------|--------------------|--|---------|
| Frame | : 182/4T | Locked rotor current (I _l /I _n) | : 8.4 |
| Output | : 3 HP | Duty cycle | : S1 |
| Frequency | : 60 Hz | Service factor | : 1.15 |
| Full load speed | : 1765 rpm | Design | : B |
| Voltage | : 208-230/460 V | Locked rotor torque | : 220 % |
| Rated current | : 8.54-7.72/3.86 A | Breakdown torque | : 330 % |
| Insulation class | : F | | |

Notes:
Downloaded from <http://dealerselectric.com>
Generated for Model #00318OT3E182T-S

Performed by

Checked

1 2 3 4 5 6 7 8

A

B

C

D

E

F

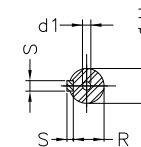
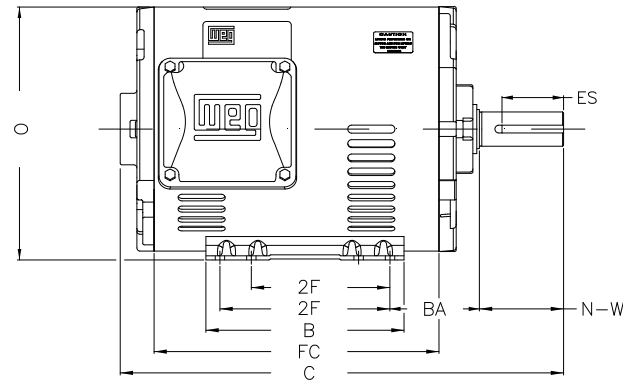
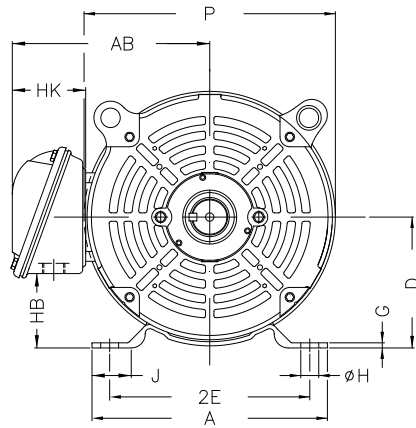
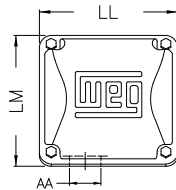

Notes: Downloaded from <http://dealerselectric.com>
Generated for Model #003180T3E182T-S

Performed by:

Checked:

Customer:

Three Phase: W01 (Rolled Steel) - ODP - NEMA Premium Efficiency

Three-phase induction motor
Frame 182/4T - ODP

12-SEP-2016



| | | | | |
|--------|-------------|--------|--------|-------|
| P | AB | J | 2E | A |
| 8.114 | 6.696 | 1.299 | 7.500 | 8.661 |
| H | G | HB | HK | O |
| 0.406 | 0.167 | 2.784 | 2.629 | 8.557 |
| FC | 2F | B | C | BA |
| 9.055 | 4.500/5.500 | 6.299 | 15.157 | 2.750 |
| N-W | ES | d1 | S | U |
| 2.750 | 1.969 | A 3,15 | 0.250 | 1.125 |
| AA | depth | R | LL | LM |
| 1.118" | 0.250 | 0.984 | 4.563 | 4.090 |
| BB | D | CH | | |
| 0.000 | 4.500 | 1.377 | | |

1 2 3 4 5 6 7 8

LOW VOLTAGE

HIGH VOLTAGE

A
B
C
D
E
F

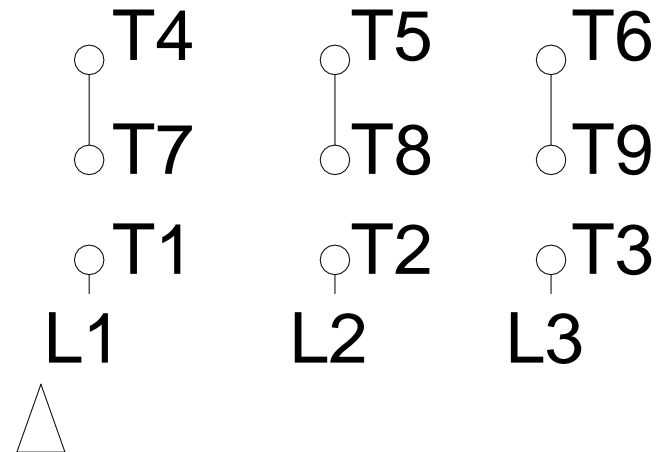

| | | |
|--|-------------|---|
| Notes: Downloaded from http://dealerselectric.com Generated for Model #003180T3E182T-S | | |
| Performed by: | | |
| Checked: | | |
| Customer: | | |
| Three Phase: W01 (Rolled Steel) - ODP - NEMA Premium Efficiency | | |
| Three-phase induction motor Frame 182/4T - IP21 | 12-SEP-2016 |  |