



Dealers Industrial Equipment

No.:

Date: 12-SEP-2016

Customer :

TECHNICAL PROPOSAL

Three-phase induction motor - Squirrel cage rotor

Product line : W22 NEMA Premium - Ball Bearings

Catalog Number : 00318ET3H182T-W22

List Price : \$663

Notes:

Downloaded from <http://dealerselectric.com>

Generated for Model #00318ET3H182T-W22

Performed by:

Checked:



Dealers Industrial Equipment

No.:

Date: 12-SEP-2016

DATA SHEET Three-phase induction motor - Squirrel cage rotor

Customer :
 Product line : W22 NEMA Premium - Ball Bearings

Frame : 182/4T
 Output : 3 HP
 Frequency : 60 Hz
 Poles : 4
 Full load speed : 1760 rpm
 Slip : 2.22 %
 Voltage : 575 V
 Rated current : 3.13 A
 Locked rotor current : 25.3 A
 Locked rotor current (I_L/I_n) : 8.1
 No-load current : 1.60 A
 Full load torque : 8.83 lb.ft
 Locked rotor torque : 230 %
 Breakdown torque : 340 %
 Design : B
 Insulation class : F
 Temperature rise : 80 K
 Locked rotor time : 23 s (hot)
 Service factor : 1.25
 Duty cycle : S1
 Ambient temperature : -20°C - +40°C
 Altitude : 1000 m
 Degree of Protection : IP55
 Approximate weight : 90 lb
 Moment of inertia : 0.34005 sq.ft.lb
 Noise level : 56 dB(A)

	D.E.	N.D.E.
Bearings	6207 ZZ	6206 ZZ
Regreasing interval	---	---
Grease amount	---	---

Load	Power factor	Efficiency (%)
100%	0.79	89.5
75%	0.73	88.5
50%	0.61	87.5

Notes:
 Downloaded from <http://dealerselectric.com>
 Generated for Model #00318ET3H182T-W22

Performed by

Checked



Dealers Industrial Equipment

No.:

Date: 12-SEP-2016

PERFORMANCE CURVES RELATED TO RATED OUTPUT

Three-phase induction motor - Squirrel cage rotor

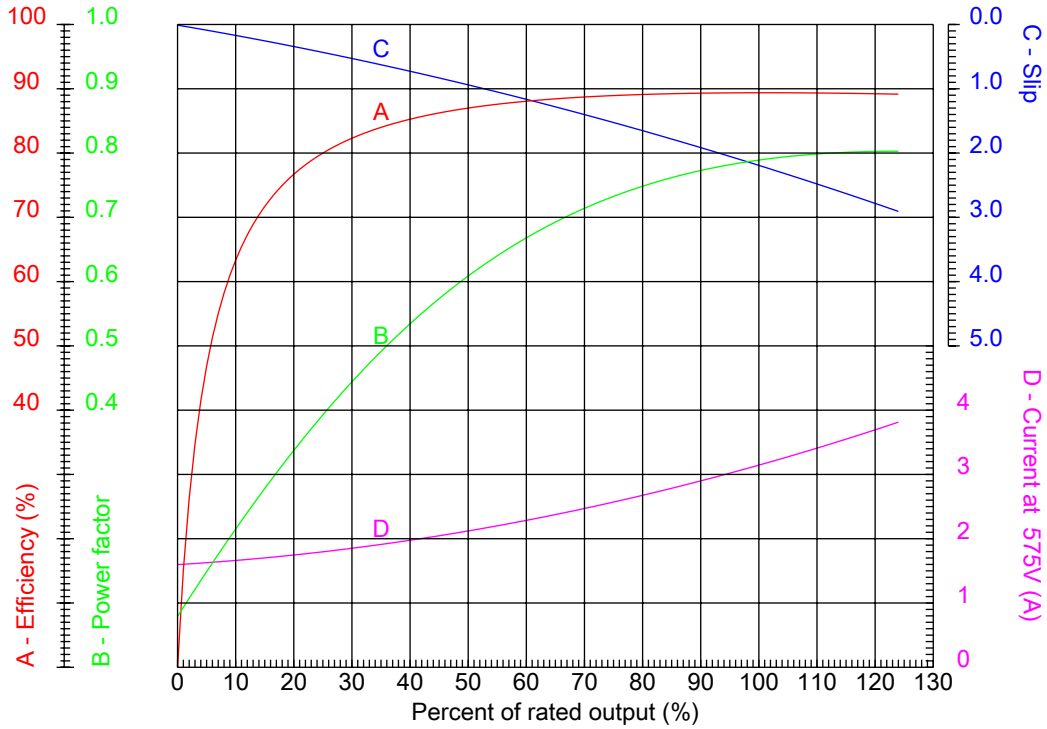

Customer :
 Product line : W22 NEMA Premium - Ball Bearings

Frame : 182/4T	Locked rotor current (I _L /I _n) : 8.1
Output : 3 HP	Duty cycle : S1
Frequency : 60 Hz	Service factor : 1.25
Full load speed : 1760 rpm	Design : B
Voltage : 575 V	Locked rotor torque : 230 %
Rated current : 3.13 A	Breakdown torque : 340 %
Insulation class : F	

Notes:
 Downloaded from <http://dealerselectric.com>
 Generated for Model #00318ET3H182T-W22

Performed by

Checked



Dealers Industrial Equipment

No.:

Date: 12-SEP-2016

CHARACTERISTIC CURVES RELATED TO SPEED

Three-phase induction motor - Squirrel cage rotor

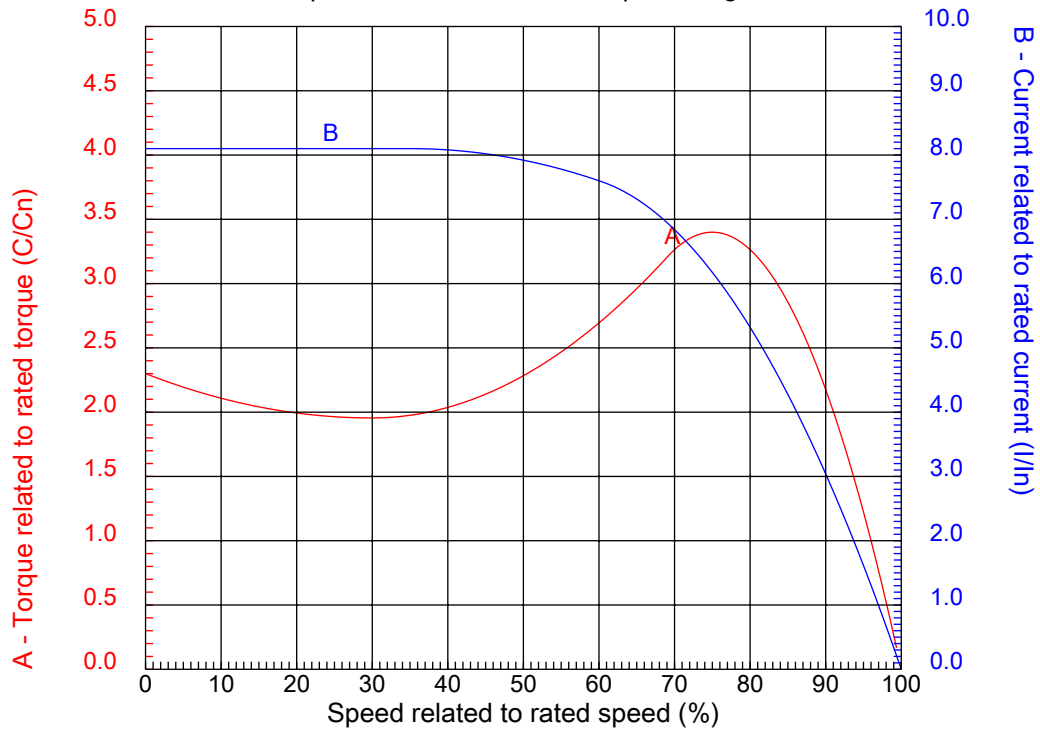

Customer :
Product line : W22 NEMA Premium - Ball Bearings

Frame	: 182/4T	Locked rotor current (I _l /I _n)	: 8.1
Output	: 3 HP	Duty cycle	: S1
Frequency	: 60 Hz	Service factor	: 1.25
Full load speed	: 1760 rpm	Design	: B
Voltage	: 575 V	Locked rotor torque	: 230 %
Rated current	: 3.13 A	Breakdown torque	: 340 %
Insulation class	: F		

Notes:
Downloaded from <http://dealerselectric.com>
Generated for Model #00318ET3H182T-W22

Performed by

Checked

1 2 3 4 5 6 7 8

A

B

C

D

E

F

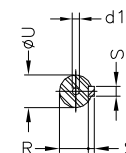
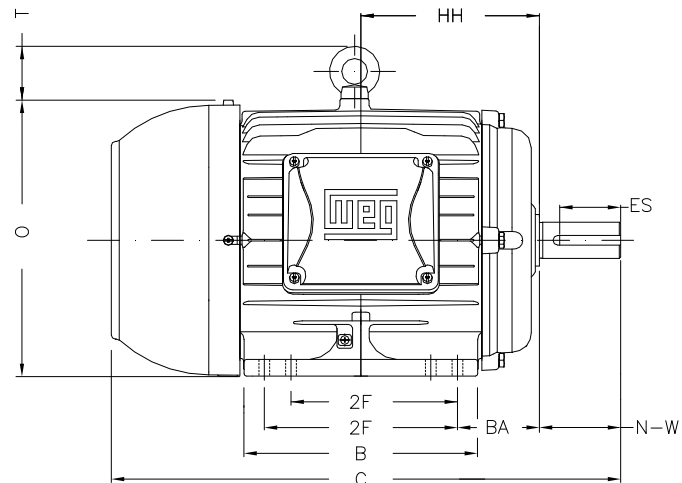
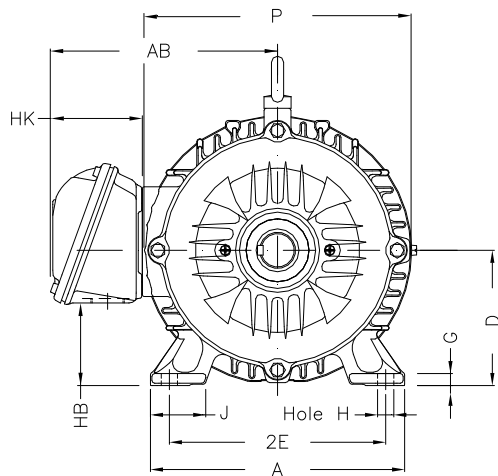
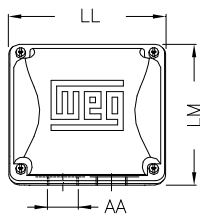

Notes: Downloaded from <http://dealerselectric.com>
Generated for Model #00318ET3H182T-W22

2E 7.500	J 1.614	A 8.661	P 8.937	AB 7.565
2F 4.500/5.500	B 6.969	BA 2.750	FBA 5.057	U 1.125
N-W 2.750	ES 1.969	S 0.250	R 0.984	depth 0.250
D 4.500	G 0.394	HB 2.236	O 9.343	T 1.772
HF 4.500	HH 5.500	HK 3.150	EV 0.734	H 0.410
C 15.860	FC 18.307	LL 5.512	LM 5.236	AA NPT 1"
d1 A 4				

Performed by:

Checked:

Customer:

W22 NEMA Premium - Ball Bearings

Three-phase induction motor
Frame 182/4T - IP55

12-SEP-2016



1 2 3 4 5 6 7 8

A

B

C

D

E

F



Notes: Downloaded from <http://dealerselectric.com>
Generated for Model #00318ET3H182T-W22

Performed by:

Checked:

Customer:

W22 NEMA Premium - Ball Bearings

Three-phase induction motor
Frame 182/4T - IP55

12-SEP-2016

