



Dealers Industrial Equipment

No.:

Date: 12-SEP-2016

Customer :

TECHNICAL PROPOSAL

Three-phase induction motor - Squirrel cage rotor

Product line : Three Phase: W01 (Rolled Steel) - TEFC - NEMA Premium Efficiency

Catalog Number : 00318ET3H182T-S

List Price : \$577

Notes:

Downloaded from <http://dealerselectric.com>

Generated for Model #00318ET3H182T-S

Performed by:

Checked:



# Dealers Industrial Equipment

No.:

Date: 12-SEP-2016

## DATA SHEET Three-phase induction motor - Squirrel cage rotor

Customer :  
 Product line : Three Phase: W01 (Rolled Steel) - TEFC - NEMA Premium Efficiency

Frame : 182/4T  
 Output : 3 HP  
 Frequency : 60 Hz  
 Poles : 4  
 Full load speed : 1765 rpm  
 Slip : 1.94 %  
 Voltage : 575 V  
 Rated current : 3.05 A  
 Locked rotor current : 26.8 A  
 Locked rotor current (I<sub>L</sub>/I<sub>n</sub>) : 8.8  
 No-load current : 1.60 A  
 Full load torque : 8.81 lb.ft  
 Locked rotor torque : 220 %  
 Breakdown torque : 300 %  
 Design : B  
 Insulation class : F  
 Temperature rise : 80 K  
 Locked rotor time : 18 s (hot)  
 Service factor : 1.15  
 Duty cycle : S1  
 Ambient temperature : -20°C - +40°C  
 Altitude : 1000 m  
 Degree of Protection : IP55  
 Approximate weight : 80 lb  
 Moment of inertia : 0.40175 sq.ft.lb  
 Noise level : 56 dB(A)

	D.E.	N.D.E.
Bearings	6206 ZZ	6205 ZZ
Regreasing interval	---	---
Grease amount	---	---

Load	Power factor	Efficiency (%)
100%	0.81	89.5
75%	0.74	88.5
50%	0.61	87.5

Notes:  
 Downloaded from <http://dealerselectric.com>  
 Generated for Model #00318ET3H182T-S

Performed by

Checked



# Dealers Industrial Equipment

No.:

Date: 12-SEP-2016

## PERFORMANCE CURVES RELATED TO RATED OUTPUT

Three-phase induction motor - Squirrel cage rotor

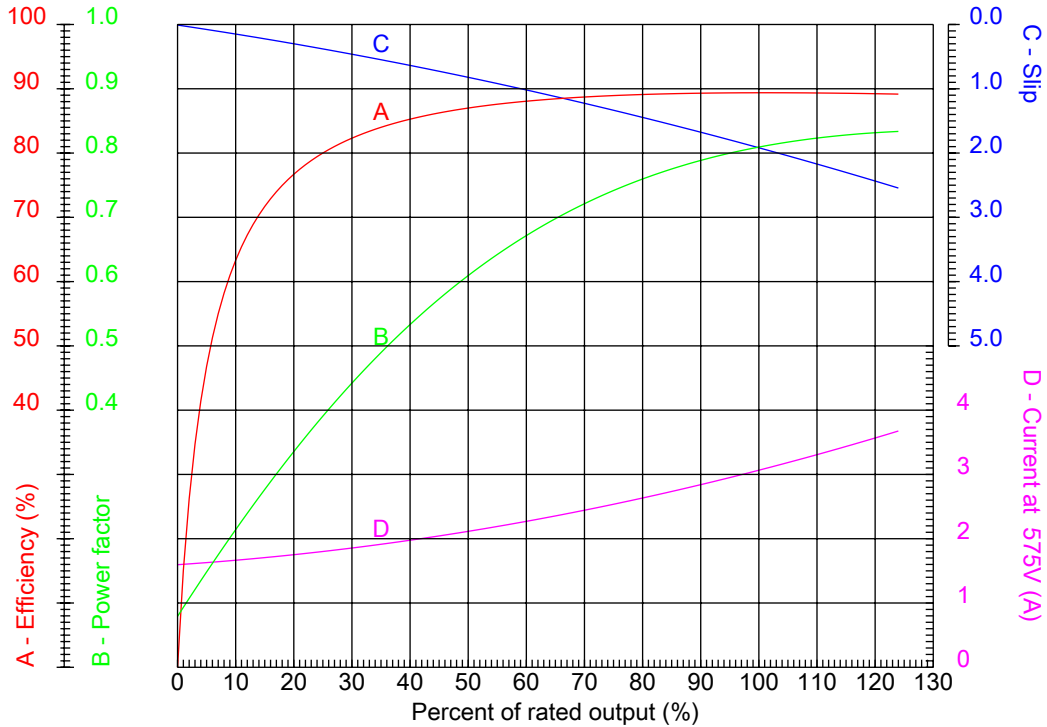

Customer :  
Product line : Three Phase: W01 (Rolled Steel) - TEFC - NEMA Premium Efficiency

Frame : 182/4T	Locked rotor current (I <sub>l</sub> /I <sub>n</sub> ) : 8.8
Output : 3 HP	Duty cycle : S1
Frequency : 60 Hz	Service factor : 1.15
Full load speed : 1765 rpm	Design : B
Voltage : 575 V	Locked rotor torque : 220 %
Rated current : 3.05 A	Breakdown torque : 300 %
Insulation class : F	

Notes:  
Downloaded from <http://dealerselectric.com>  
Generated for Model #00318ET3H182T-S

Performed by

Checked



## CHARACTERISTIC CURVES RELATED TO SPEED

Three-phase induction motor - Squirrel cage rotor

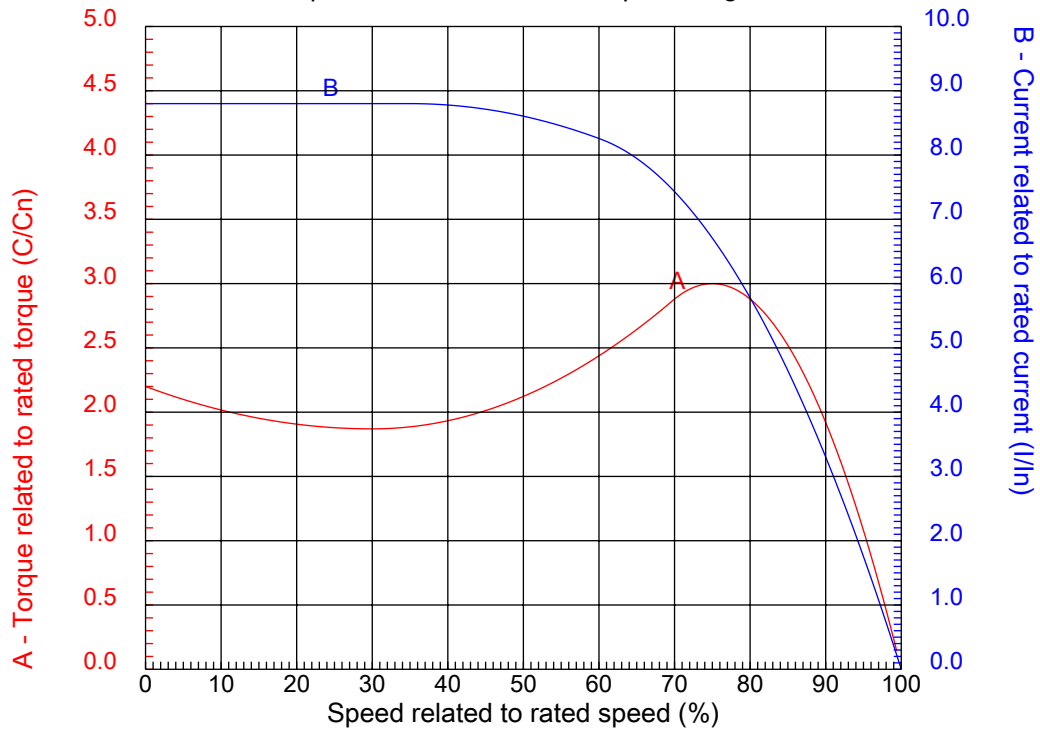

Customer :  
Product line : Three Phase: W01 (Rolled Steel) - TEFC - NEMA Premium Efficiency

Frame	: 182/4T	Locked rotor current (I <sub>l</sub> /I <sub>n</sub> )	: 8.8
Output	: 3 HP	Duty cycle	: S1
Frequency	: 60 Hz	Service factor	: 1.15
Full load speed	: 1765 rpm	Design	: B
Voltage	: 575 V	Locked rotor torque	: 220 %
Rated current	: 3.05 A	Breakdown torque	: 300 %
Insulation class	: F		

Notes:  
Downloaded from <http://dealerselectric.com>  
Generated for Model #00318ET3H182T-S

Performed by

Checked

1 2 3 4 5 6 7 8

A

B

C

D

E

F

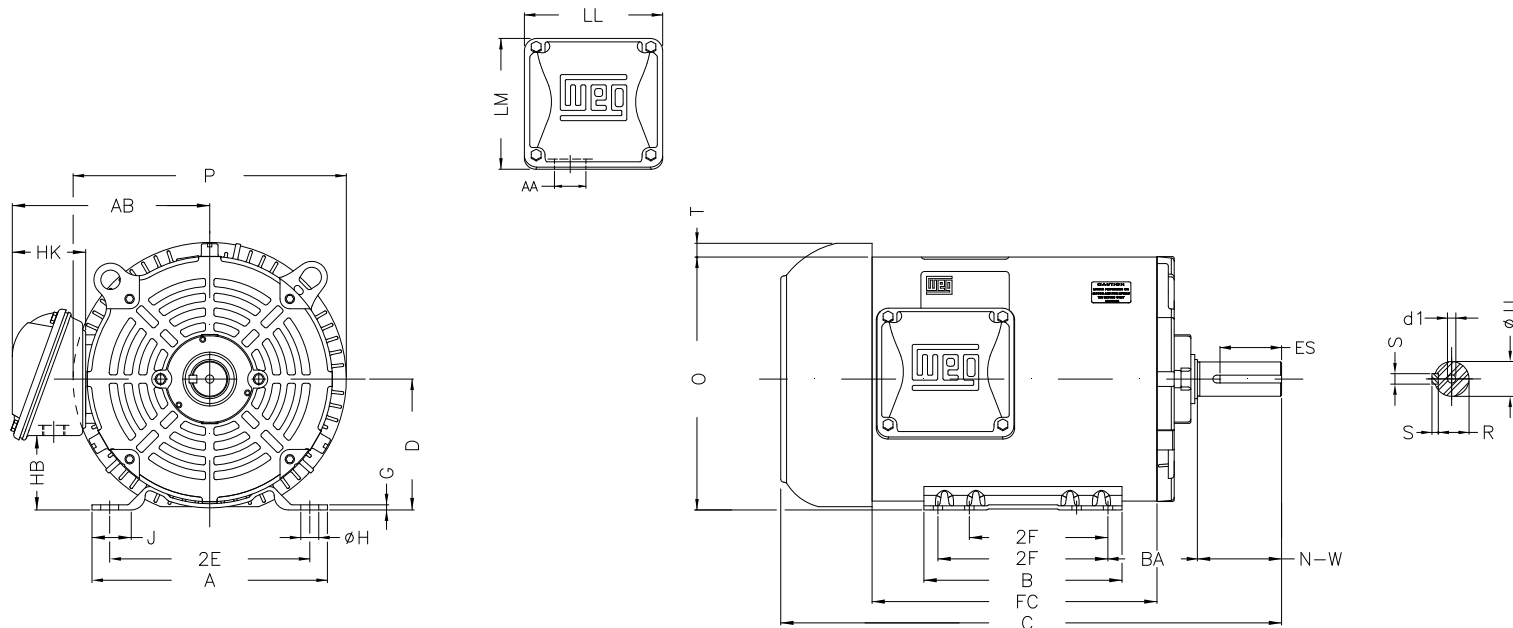

Notes: Downloaded from <http://dealerselectric.com>  
Generated for Model #00318ET3H182T-S

Performed by:

Checked:

Customer:

Three Phase: W01 (Rolled Steel) - TEFC - NEMA Premium Efficiency

Three-phase induction motor  
Frame 182/4T - IP55

12-SEP-2016



P	AB	J	2E	A
9.435	6.696	1.299	7.500	8.661
H	G	HB	HK	T
0.406	0.167	2.784	2.629	0.661
O	FC	2F	B	C
8.557	10.236	4.500/5.500	6.299	17.913
BA	N-W	ES	d1	S
2.750	2.750	1.969	A 3,15	0.250
U	AA	depth	R	LL
1.125	1.118"	0.250	0.984	4.563
LM	BB	D	CH	
4.090	0.661	4.500	1.377	

1 2 3 4 5 6 7 8

A

B

C

D

E

F



Notes: Downloaded from <http://dealerselectric.com>  
Generated for Model #00318ET3H182T-S

Performed by:

Checked:

Customer:

Three Phase: W01 (Rolled Steel) - TEFC - NEMA Premium Efficiency

Three-phase induction motor  
Frame 182/4T - IP55

12-SEP-2016

