



Dealers Industrial Equipment

No.:

Date: 12-SEP-2016

Customer :

TECHNICAL PROPOSAL

Three-phase induction motor - Squirrel cage rotor

Product line : Three-Phase : Rolled Steel Motor - NEMA Premium Efficiency

Catalog Number : 00318ET3ERS182TC

List Price : \$>(discontinued)

Notes:

Downloaded from <http://dealerselectric.com>

Generated for Model #00318ET3ERS182TC

Performed by:

Checked:



Dealers Industrial Equipment

No.:

Date: 12-SEP-2016

DATA SHEET Three-phase induction motor - Squirrel cage rotor

Customer :
 Product line : Three-Phase : Rolled Steel Motor - NEMA Premium Efficiency

Frame : 182T
 Output : 3 HP
 Frequency : 60 Hz
 Poles : 4
 Full load speed : 1760 rpm
 Slip : 2.22 %
 Voltage : 208-230/460 V
 Rated current : 8.65-7.82/3.91 A
 Locked rotor current : 62.6/31.3 A
 Locked rotor current (I_L/I_n) : 8.0
 No-load current : 4.10/2.05 A
 Full load torque : 8.83 lb.ft
 Locked rotor torque : 250 %
 Breakdown torque : 320 %
 Design : B
 Insulation class : F
 Temperature rise : 80 K
 Locked rotor time : 33 s (hot)
 Service factor : 1.15
 Duty cycle : S1
 Ambient temperature : -20°C - +40°C
 Altitude : 1000 m
 Degree of Protection : IP55
 Approximate weight : 76 lb
 Moment of inertia : 0.34954 sq.ft.lb
 Noise level : ---

	D.E.	N.D.E.
Bearings	6206 ZZ	6206 ZZ
Regreasing interval	---	---
Grease amount	---	---

Load	Power factor	Efficiency (%)
100%	0.79	89.5
75%	0.72	89.5
50%	0.60	87.5

Notes:
 Downloaded from <http://dealerselectric.com>
 Generated for Model #00318ET3ERS182TC

Performed by

Checked



Dealers Industrial Equipment

No.:

Date: 12-SEP-2016

PERFORMANCE CURVES RELATED TO RATED OUTPUT Three-phase induction motor - Squirrel cage rotor

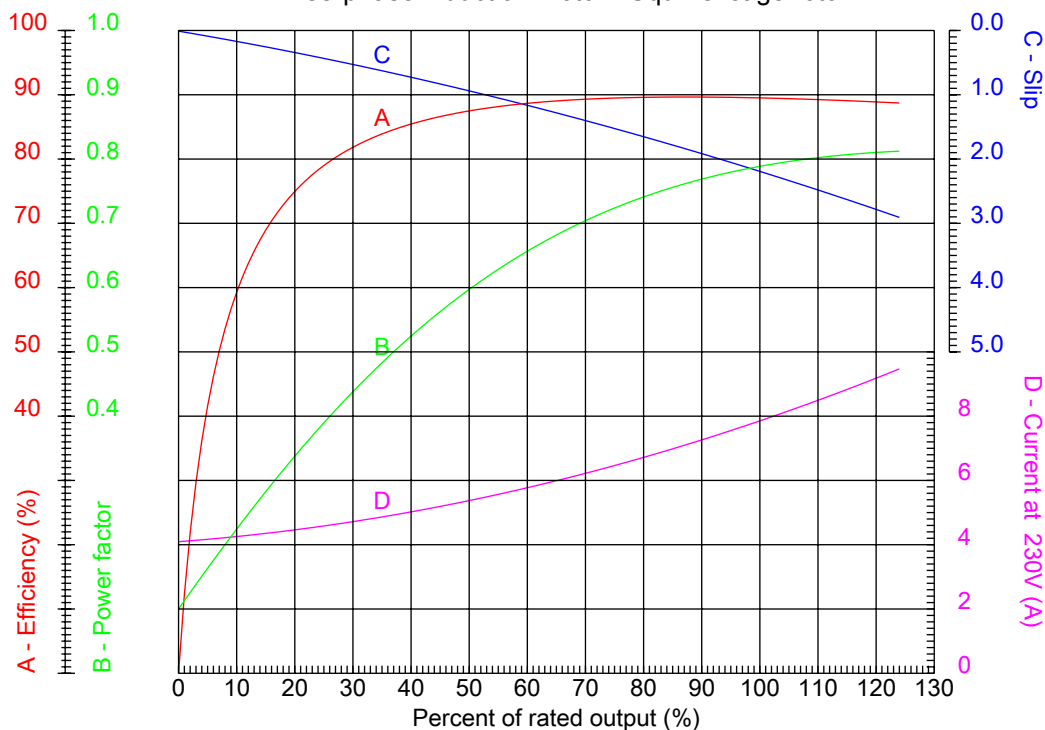

Customer :
Product line : Three-Phase : Rolled Steel Motor - NEMA Premium Efficiency

Frame	: 182T	Locked rotor current (I _L /I _n)	: 8.0
Output	: 3 HP	Duty cycle	: S1
Frequency	: 60 Hz	Service factor	: 1.15
Full load speed	: 1760 rpm	Design	: B
Voltage	: 208-230/460 V	Locked rotor torque	: 250 %
Rated current	: 8.65-7.82/3.91 A	Breakdown torque	: 320 %
Insulation class	: F		

Notes:
Downloaded from <http://dealerselectric.com>
Generated for Model #00318ET3ERS182TC

Performed by

Checked



Dealers Industrial Equipment

No.:

Date: 12-SEP-2016

CHARACTERISTIC CURVES RELATED TO SPEED

Three-phase induction motor - Squirrel cage rotor

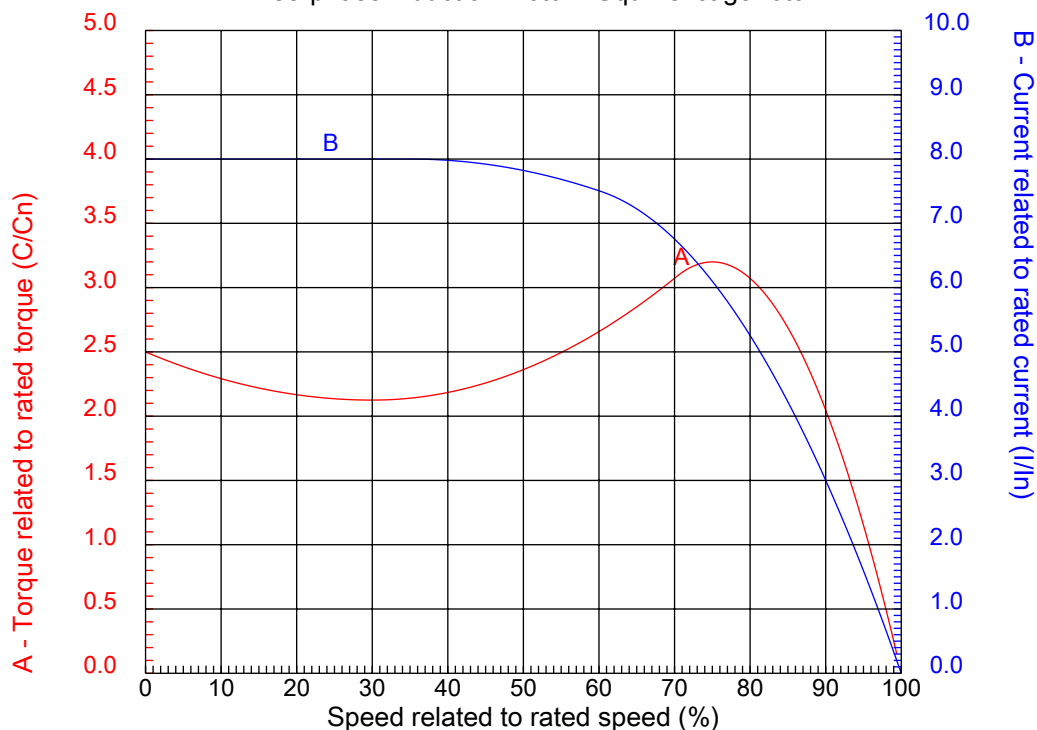

Customer :
Product line : Three-Phase : Rolled Steel Motor - NEMA Premium Efficiency

Frame	: 182T	Locked rotor current (I _l /I _n)	: 8.0
Output	: 3 HP	Duty cycle	: S1
Frequency	: 60 Hz	Service factor	: 1.15
Full load speed	: 1760 rpm	Design	: B
Voltage	: 208-230/460 V	Locked rotor torque	: 250 %
Rated current	: 8.65-7.82/3.91 A	Breakdown torque	: 320 %
Insulation class	: F		

Notes:
Downloaded from <http://dealerselectric.com>
Generated for Model #00318ET3ERS182TC

Performed by

Checked

1 2 3 4 5 6 7 8

A
B
C
D
E
F

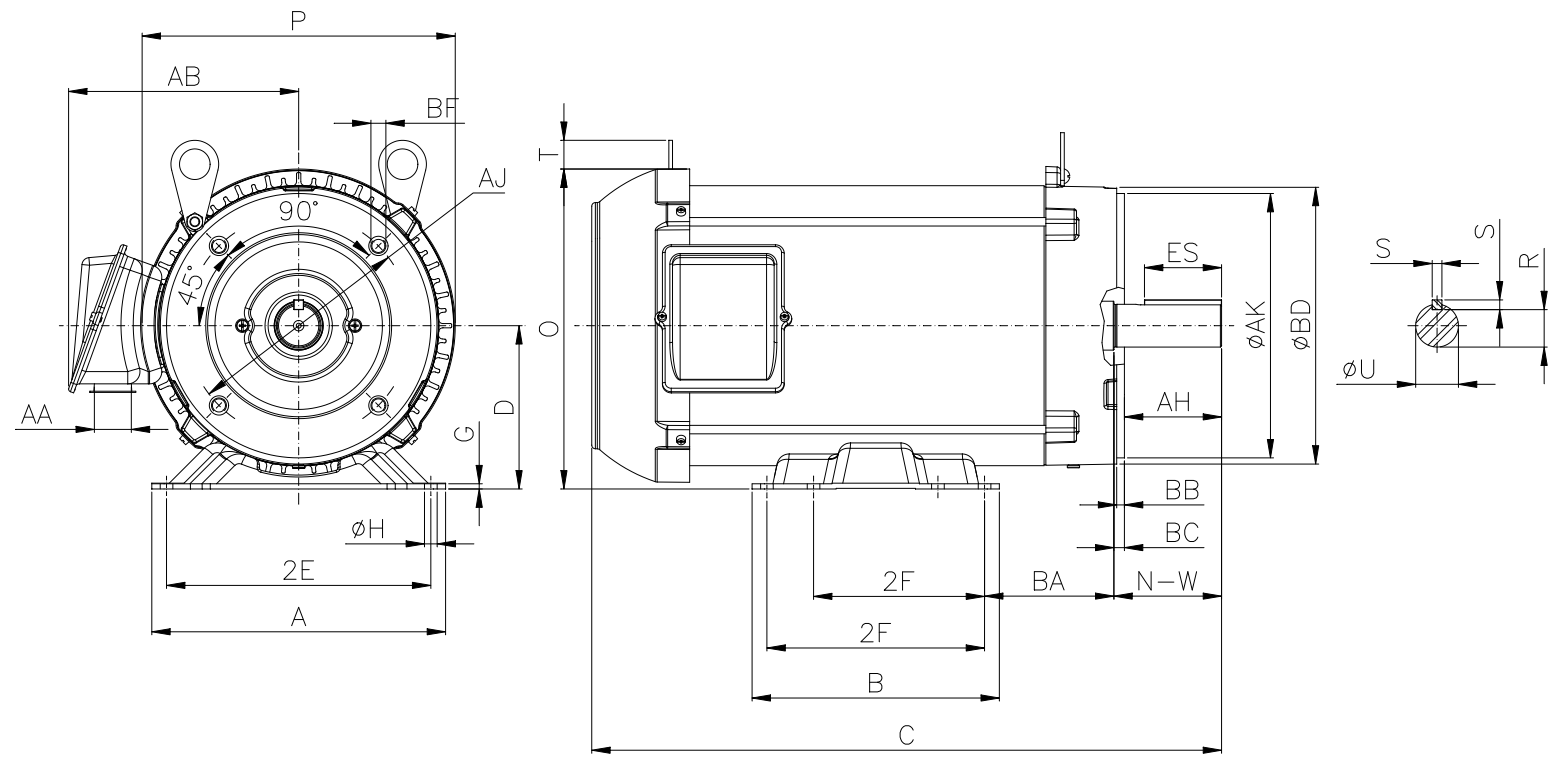

Notes: Downloaded from <http://dealerselectric.com>
Generated for Model #00318ET3ERS182TC

Performed by:

Checked:

Customer:

Three-Phase : Rolled Steel Motor - NEMA Premium Efficiency

2E	A	P	AB	2F
7.500	8.661	8.694	6.353	4.500/5.500
B	BA	U	N-W	ES
6.299	3.500	1.125	2.750	1.969
S	R	depth	D	G
0.250	0.984	0.250	4.500	0.167
O	T	H	C	d1
8.847	0.902	0.406	16.404	A 4
d2	Flange	AJ	AK	BD
A 4	FC-184	7.250	8.500	8.875
BF	BB	BC	AH	
UNC 1/2"x13	0.250	0.125	2.625	

Three-phase induction motor
Frame 182T - IP55

12-SEP-2016



1 2 3 4 5 6 7 8

LOW VOLTAGE

HIGH VOLTAGE

A
B
C
D
E
F

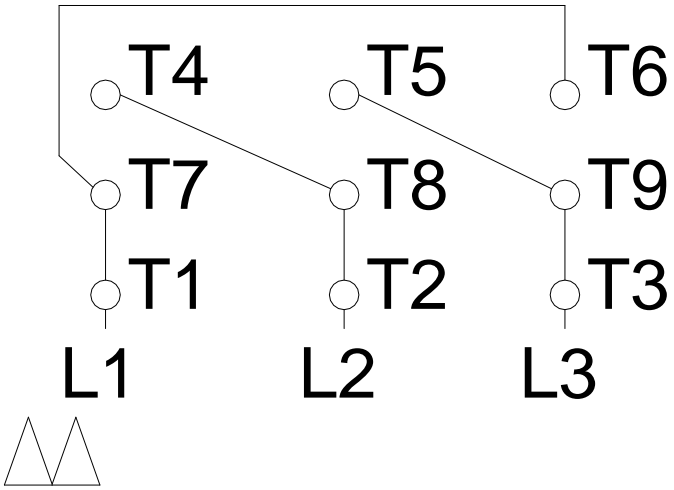

Notes: Downloaded from http://dealerselectric.com Generated for Model #00318ET3ERS182TC		
Performed by:		
Checked:		
Customer:		
Three-Phase : Rolled Steel Motor - NEMA Premium Efficiency		
Three-phase induction motor Frame 182T - IP55	12-SEP-2016	