



Dealers Industrial Equipment

No.:

Date: 12-SEP-2016

Customer :

TECHNICAL PROPOSAL

Three-phase induction motor - Squirrel cage rotor

Product line : Three Phase: W01 (Rolled Steel) - TEFC - NEMA Premium Efficiency

Catalog Number : 00318ET3ER182TC-S

List Price : \$610

Notes:

Downloaded from <http://dealerselectric.com>

Generated for Model #00318ET3ER182TC-S

Performed by:

Checked:



# Dealers Industrial Equipment

No.:

Date: 12-SEP-2016

## DATA SHEET Three-phase induction motor - Squirrel cage rotor

Customer :  
 Product line : Three Phase: W01 (Rolled Steel) - TEFC - NEMA Premium Efficiency

Frame : 182/4T  
 Output : 3 HP  
 Frequency : 60 Hz  
 Poles : 4  
 Full load speed : 1765 rpm  
 Slip : 1.94 %  
 Voltage : 208-230/460 V  
 Rated current : 8.43-7.62/3.81 A  
 Locked rotor current : 67.1/33.5 A  
 Locked rotor current (I<sub>L</sub>/I<sub>n</sub>) : 8.8  
 No-load current : 4.00/2.00 A  
 Full load torque : 8.81 lb.ft  
 Locked rotor torque : 220 %  
 Breakdown torque : 300 %  
 Design : B  
 Insulation class : F  
 Temperature rise : 80 K  
 Locked rotor time : 18 s (hot)  
 Service factor : 1.15  
 Duty cycle : S1  
 Ambient temperature : -20°C - +40°C  
 Altitude : 1000 m  
 Degree of Protection : IP55  
 Approximate weight : 80 lb  
 Moment of inertia : 0.40175 sq.ft.lb  
 Noise level : 56 dB(A)

	D.E.	N.D.E.
Bearings	6206 ZZ	6205 ZZ
Regreasing interval	---	---
Grease amount	---	---

Load	Power factor	Efficiency (%)
100%	0.81	89.5
75%	0.74	88.5
50%	0.61	87.5

Notes:  
 Downloaded from <http://dealerselectric.com>  
 Generated for Model #00318ET3ER182TC-S

Performed by

Checked



# Dealers Industrial Equipment

No.:

Date: 12-SEP-2016

## PERFORMANCE CURVES RELATED TO RATED OUTPUT

Three-phase induction motor - Squirrel cage rotor

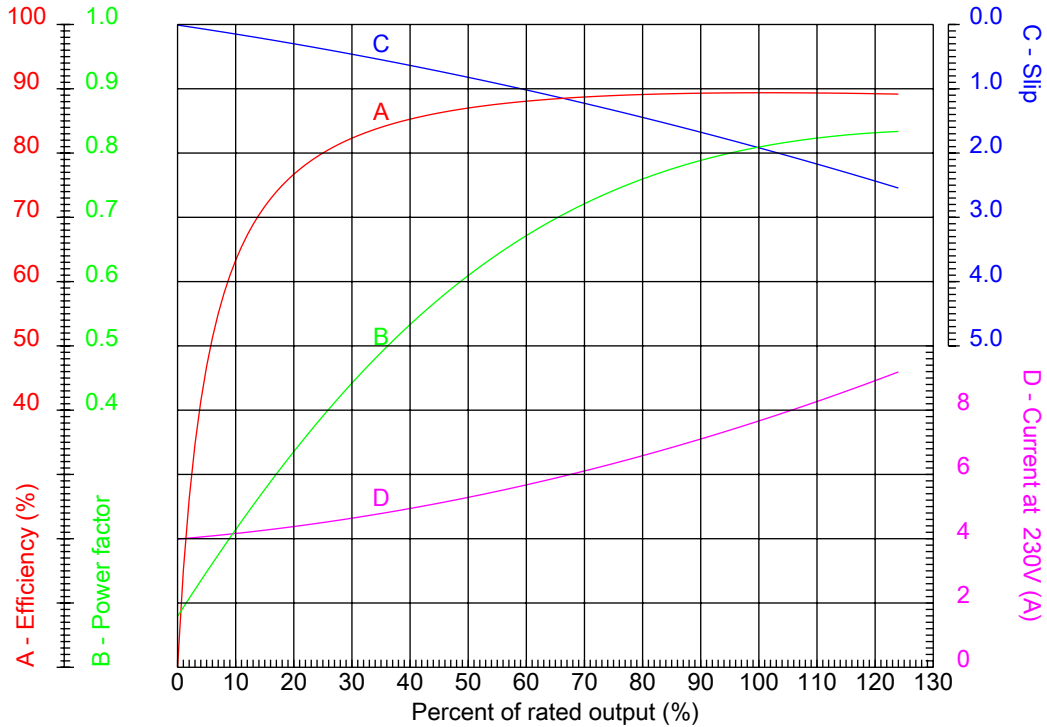

Customer :  
 Product line : Three Phase: W01 (Rolled Steel) - TEFC - NEMA Premium Efficiency

Frame	: 182/4T	Locked rotor current (I <sub>l</sub> /I <sub>n</sub> )	: 8.8
Output	: 3 HP	Duty cycle	: S1
Frequency	: 60 Hz	Service factor	: 1.15
Full load speed	: 1765 rpm	Design	: B
Voltage	: 208-230/460 V	Locked rotor torque	: 220 %
Rated current	: 8.43-7.62/3.81 A	Breakdown torque	: 300 %
Insulation class	: F		

Notes:  
 Downloaded from <http://dealerselectric.com>  
 Generated for Model #00318ET3ER182TC-S

Performed by

Checked



# Dealers Industrial Equipment

No.:

Date: 12-SEP-2016

## CHARACTERISTIC CURVES RELATED TO SPEED

Three-phase induction motor - Squirrel cage rotor

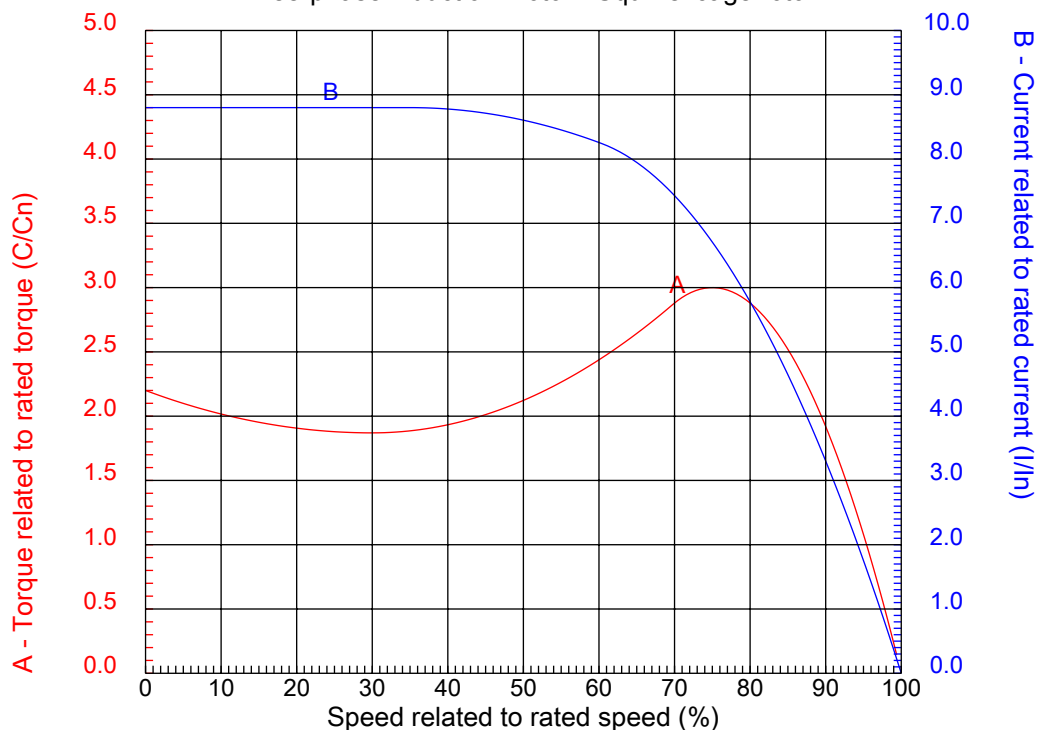

Customer :  
Product line : Three Phase: W01 (Rolled Steel) - TEFC - NEMA Premium Efficiency

Frame	: 182/4T	Locked rotor current (I <sub>l</sub> /I <sub>n</sub> )	: 8.8
Output	: 3 HP	Duty cycle	: S1
Frequency	: 60 Hz	Service factor	: 1.15
Full load speed	: 1765 rpm	Design	: B
Voltage	: 208-230/460 V	Locked rotor torque	: 220 %
Rated current	: 8.43-7.62/3.81 A	Breakdown torque	: 300 %
Insulation class	: F		

Notes:  
Downloaded from <http://dealerselectric.com>  
Generated for Model #00318ET3ER182TC-S

Performed by

Checked

1 2 3 4 5 6 7 8

A

B

C

D

E

F

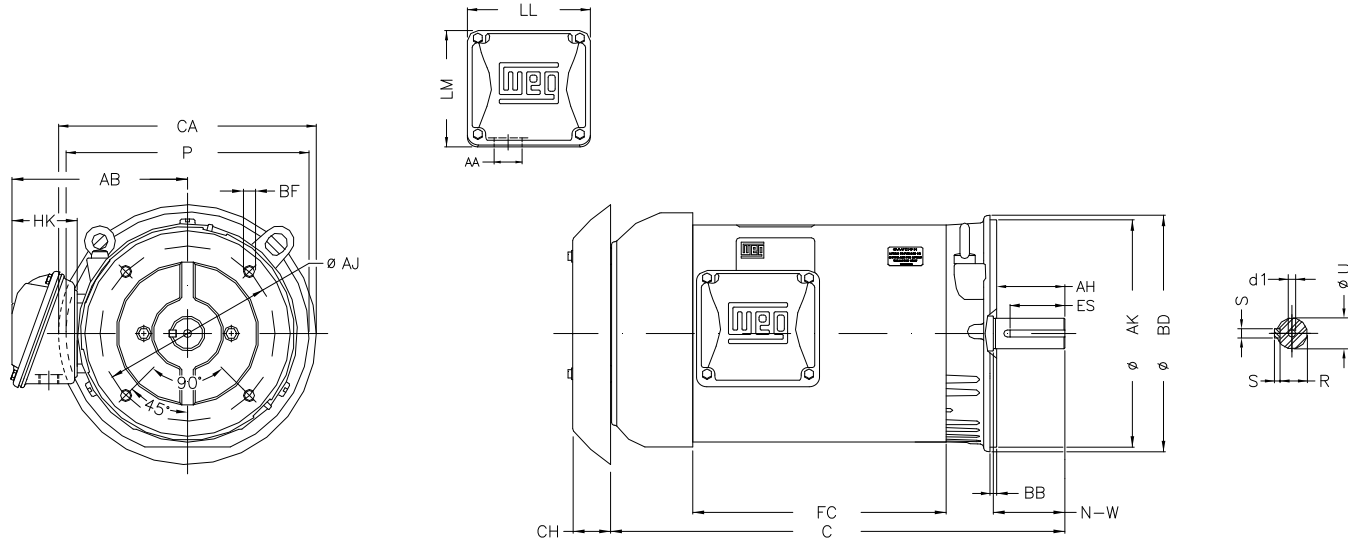

Notes: Downloaded from <http://dealerselectric.com>  
Generated for Model #00318ET3ER182TC-S

Performed by:

Checked:

Customer:

Three Phase: W01 (Rolled Steel) - TEFC - NEMA Premium Efficiency

Three-phase induction motor  
Frame 182/4T - IP55

12-SEP-2016



P	AB	HK	FC	C
9.435	6.696	2.629	10.236	17.913
N-W	ES	d1	S	U
2.750	1.969	A 3.15	0.250	1.125
AA	depth	R	LL	LM
1.118"	0.250	0.984	4.563	4.090
CH	Flange	AJ	AK	BD
1.377	FC-184	7.250	8.500	8.846
BF	BB	AH		
UNC 1/2"x13	0.250	2.620		

1 2 3 4 5 6 7 8

# LOW VOLTAGE

# HIGH VOLTAGE

A  
B  
C  
D  
E  
F



Notes: Downloaded from <http://dealerselectric.com>  
 Generated for Model #00318ET3ER182TC-S

Performed by:

Checked:

Customer:

Three Phase: W01 (Rolled Steel) - TEFC - NEMA Premium Efficiency

Three-phase induction motor  
 Frame 182/4T - IP55

12-SEP-2016

