



Dealers Industrial Equipment

No.:

Date: 12-SEP-2016

Customer :

TECHNICAL PROPOSAL

Three-phase induction motor - Squirrel cage rotor

Product line : Three-Phase : Rolled Steel Motor - NEMA Premium Efficiency

Catalog Number : 00312ET3ERS213TC

List Price : \$>(discontinued)

Notes:

Downloaded from <http://dealerselectric.com>

Generated for Model #00312ET3ERS213TC

Performed by:

Checked:



Dealers Industrial Equipment

No.:

Date: 12-SEP-2016

DATA SHEET

Three-phase induction motor - Squirrel cage rotor

Customer :
 Product line : Three-Phase : Rolled Steel Motor - NEMA Premium Efficiency

Frame : 213T
 Output : 3 HP
 Frequency : 60 Hz
 Poles : 6
 Full load speed : 1170 rpm
 Slip : 2.50 %
 Voltage : 208-230/460 V
 Rated current : 9.75-8.82/4.41 A
 Locked rotor current : 61.7/30.9 A
 Locked rotor current (I_L/I_n) : 7.0
 No-load current : 5.50/2.75 A
 Full load torque : 13.3 lb.ft
 Locked rotor torque : 200 %
 Breakdown torque : 280 %
 Design : B
 Insulation class : F
 Temperature rise : 80 K
 Locked rotor time : 58 s (hot)
 Service factor : 1.15
 Duty cycle : S1
 Ambient temperature : -20°C - +40°C
 Altitude : 1000 m
 Degree of Protection : IP55
 Approximate weight : 119 lb
 Moment of inertia : 1.1958 sq.ft.lb
 Noise level : ---

	D.E.	N.D.E.
Bearings	6208 ZZ	6206 ZZ
Regreasing interval	---	---
Grease amount	---	---

Load	Power factor	Efficiency (%)
100%	0.70	89.5
75%	0.63	88.5
50%	0.50	86.5

Notes:
 Downloaded from <http://dealerselectric.com>
 Generated for Model #00312ET3ERS213TC

Performed by

Checked



Dealers Industrial Equipment

No.:

Date: 12-SEP-2016

PERFORMANCE CURVES RELATED TO RATED OUTPUT

Three-phase induction motor - Squirrel cage rotor

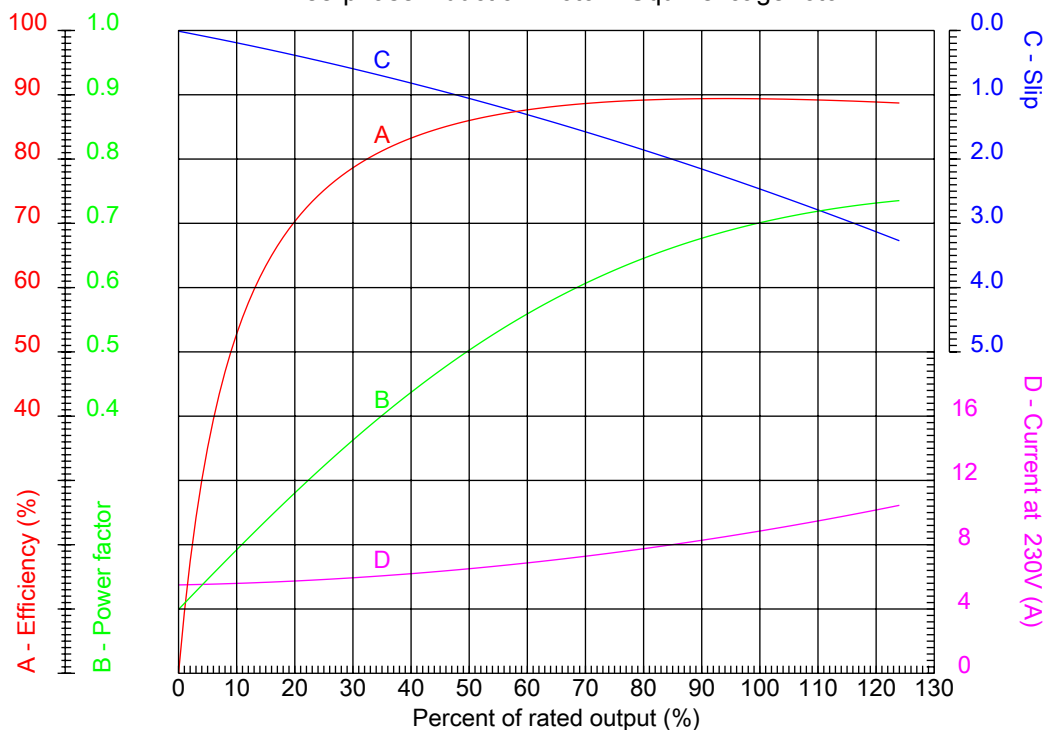

Customer :
Product line : Three-Phase : Rolled Steel Motor - NEMA Premium Efficiency

Frame : 213T	Locked rotor current (I _l /I _n) : 7.0
Output : 3 HP	Duty cycle : S1
Frequency : 60 Hz	Service factor : 1.15
Full load speed : 1170 rpm	Design : B
Voltage : 208-230/460 V	Locked rotor torque : 200 %
Rated current : 9.75-8.82/4.41 A	Breakdown torque : 280 %
Insulation class : F	

Notes:
Downloaded from <http://dealerselectric.com>
Generated for Model #00312ET3ERS213TC

Performed by

Checked



Dealers Industrial Equipment

No.:

Date: 12-SEP-2016

CHARACTERISTIC CURVES RELATED TO SPEED

Three-phase induction motor - Squirrel cage rotor

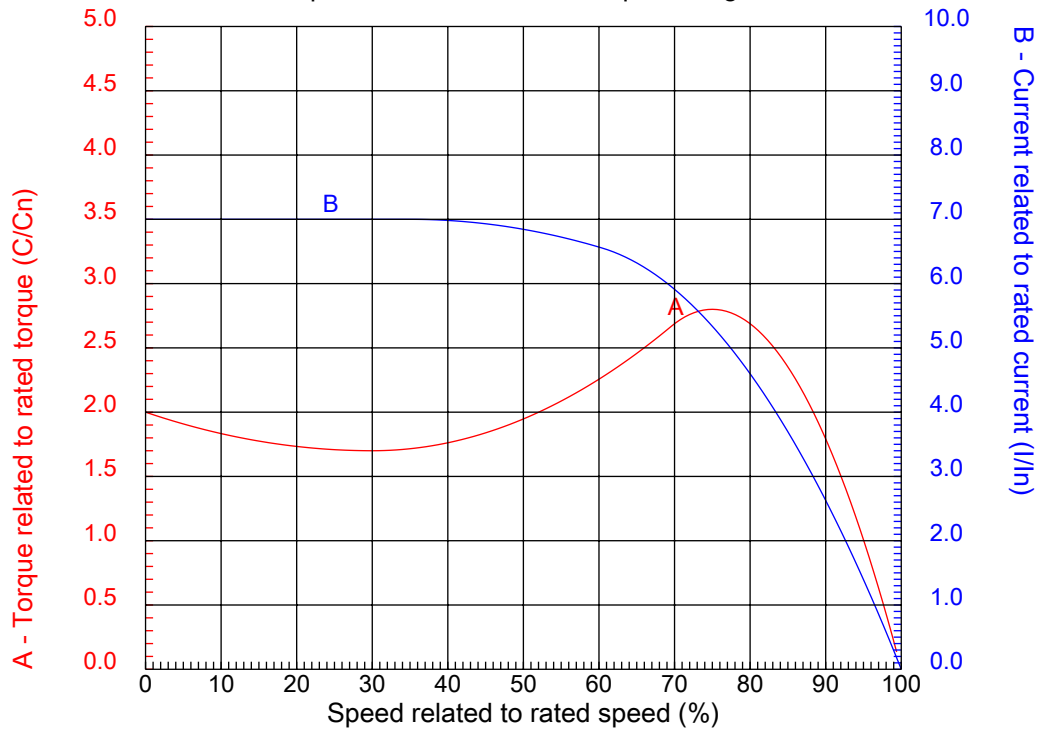

Customer :
Product line : Three-Phase : Rolled Steel Motor - NEMA Premium Efficiency

Frame	: 213T	Locked rotor current (I _l /I _n)	: 7.0
Output	: 3 HP	Duty cycle	: S1
Frequency	: 60 Hz	Service factor	: 1.15
Full load speed	: 1170 rpm	Design	: B
Voltage	: 208-230/460 V	Locked rotor torque	: 200 %
Rated current	: 9.75-8.82/4.41 A	Breakdown torque	: 280 %
Insulation class	: F		

Notes:
Downloaded from <http://dealerselectric.com>
Generated for Model #00312ET3ERS213TC

Performed by

Checked

1 2 3 4 5 6 7 8

A
B
C
D
E
F

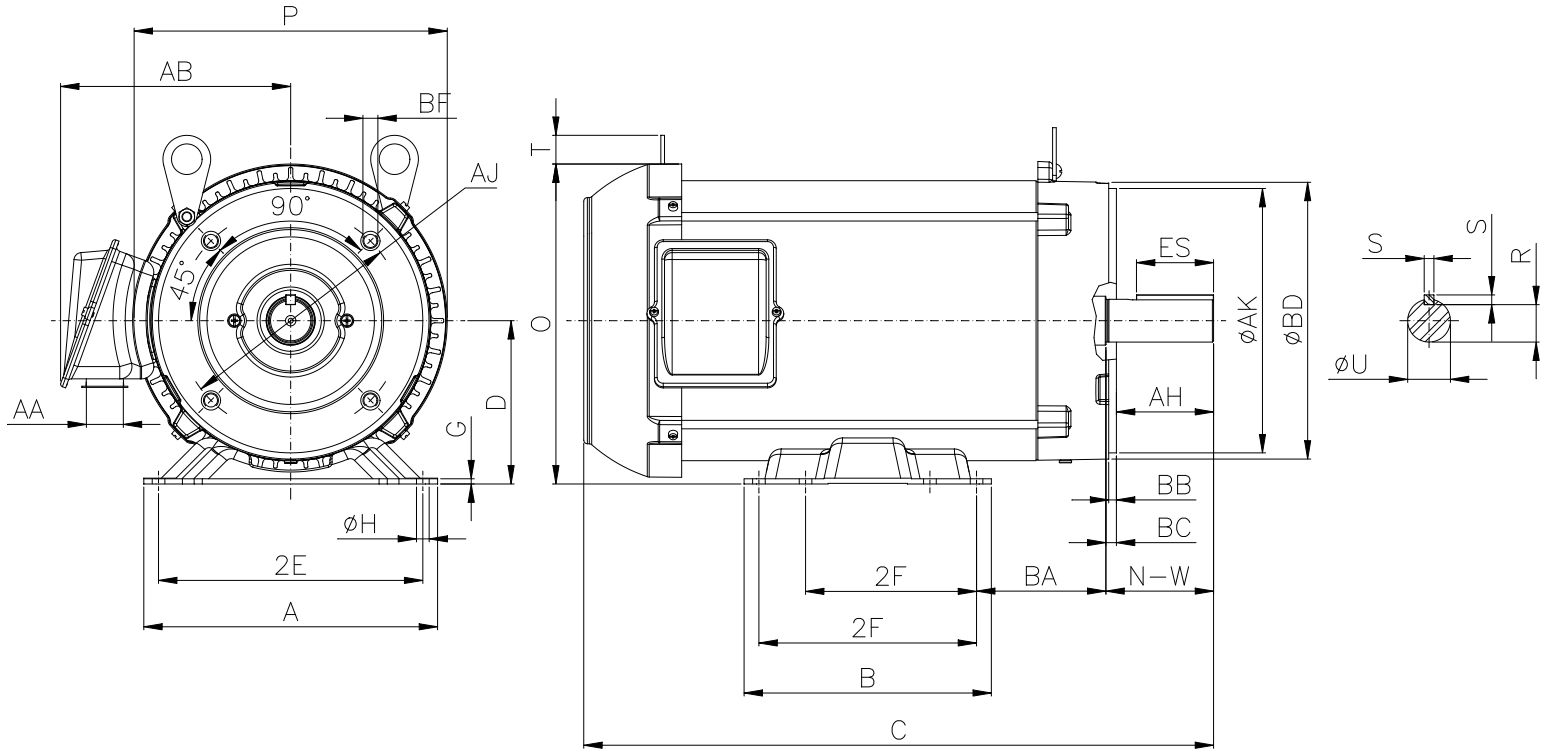

Notes: Downloaded from <http://dealerselectric.com>
Generated for Model #00312ET3ERS213TC

Performed by:

Checked:

Customer:

Three-Phase : Rolled Steel Motor - NEMA Premium Efficiency

2E	A	P	AB	2F
8.500	9.449	10.071	7.398	5.500/7.000
B	BA	U	N-W	ES
7.953	4.250	1.375	3.375	2.480
S	R	depth	D	G
0.313	1.203	0.313	5.250	0.167
O	T	H	C	d1
10.285	0.923	0.406	20.257	A 4
d2	Flange	AJ	AK	BD
A 4	FC-184	7.250	8.500	8.875
BF	BB	BC	AH	
UNC 1/2"x13	0.250	0.250	3.125	

Three-phase induction motor
Frame 213T - IP55

12-SEP-2016



1 2 3 4 5 6 7 8

LOW VOLTAGE

HIGH VOLTAGE

A
B
C
D
E
F

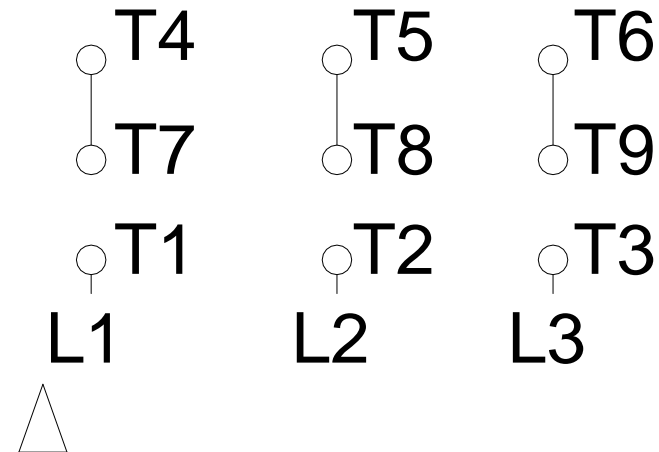

Notes: Downloaded from http://dealerselectric.com Generated for Model #00312ET3ERS213TC		
Performed by:		
Checked:		
Customer:		
Three-Phase : Rolled Steel Motor - NEMA Premium Efficiency		
Three-phase induction motor Frame 213T - IP55	12-SEP-2016	