



Dealers Industrial Equipment

No.:

Date: 12-SEP-2016

Customer :

TECHNICAL PROPOSAL

Three-phase induction motor - Squirrel cage rotor

Product line : W22 NEMA Premium - Ball Bearings

Catalog Number : 00309ET3H215T-W22

List Price : \$2,115

Notes:

Downloaded from <http://dealerselectric.com>

Generated for Model #00309ET3H215T-W22

Performed by:

Checked:



Dealers Industrial Equipment

No.:

Date: 12-SEP-2016

DATA SHEET Three-phase induction motor - Squirrel cage rotor

Customer :
 Product line : W22 NEMA Premium - Ball Bearings

Frame : 213/5T
 Output : 3 HP
 Frequency : 60 Hz
 Poles : 8
 Full load speed : 865 rpm
 Slip : 3.89 %
 Voltage : 575 V
 Rated current : 3.65 A
 Locked rotor current : 24.8 A
 Locked rotor current (I_L/I_n) : 6.8
 No-load current : 2.17 A
 Full load torque : 18.0 lb.ft
 Locked rotor torque : 230 %
 Breakdown torque : 280 %
 Design : B
 Insulation class : F
 Temperature rise : 80 K
 Locked rotor time : 44 s (hot)
 Service factor : 1.25
 Duty cycle : S1
 Ambient temperature : -20°C - +40°C
 Altitude : 1000 m
 Degree of Protection : IP55
 Approximate weight : 176 lb
 Moment of inertia : 2.1065 sq.ft.lb
 Noise level : 52 dB(A)

	D.E.	N.D.E.
Bearings	6308 ZZ	6207 ZZ
Regreasing interval	---	---
Grease amount	---	---

Load	Power factor	Efficiency (%)
100%	0.71	85.5
75%	0.63	85.5
50%	0.50	84.0

Notes:
 Downloaded from <http://dealerselectric.com>
 Generated for Model #00309ET3H215T-W22

Performed by

Checked



Dealers Industrial Equipment

No.:

Date: 12-SEP-2016

PERFORMANCE CURVES RELATED TO RATED OUTPUT

Three-phase induction motor - Squirrel cage rotor

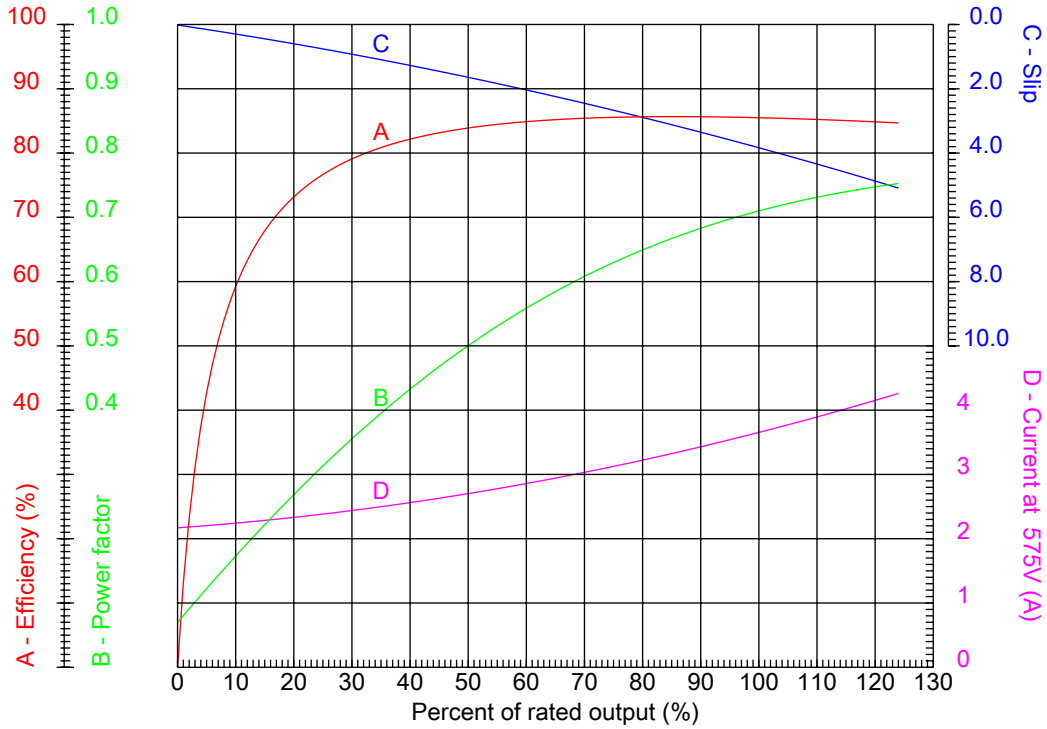

Customer :
 Product line : W22 NEMA Premium - Ball Bearings

Frame : 213/5T	Locked rotor current (I _L /I _n) : 6.8
Output : 3 HP	Duty cycle : S1
Frequency : 60 Hz	Service factor : 1.25
Full load speed : 865 rpm	Design : B
Voltage : 575 V	Locked rotor torque : 230 %
Rated current : 3.65 A	Breakdown torque : 280 %
Insulation class : F	

Notes:
 Downloaded from <http://dealerselectric.com>
 Generated for Model #00309ET3H215T-W22

Performed by

Checked



Dealers Industrial Equipment

No.:

Date: 12-SEP-2016

CHARACTERISTIC CURVES RELATED TO SPEED

Three-phase induction motor - Squirrel cage rotor

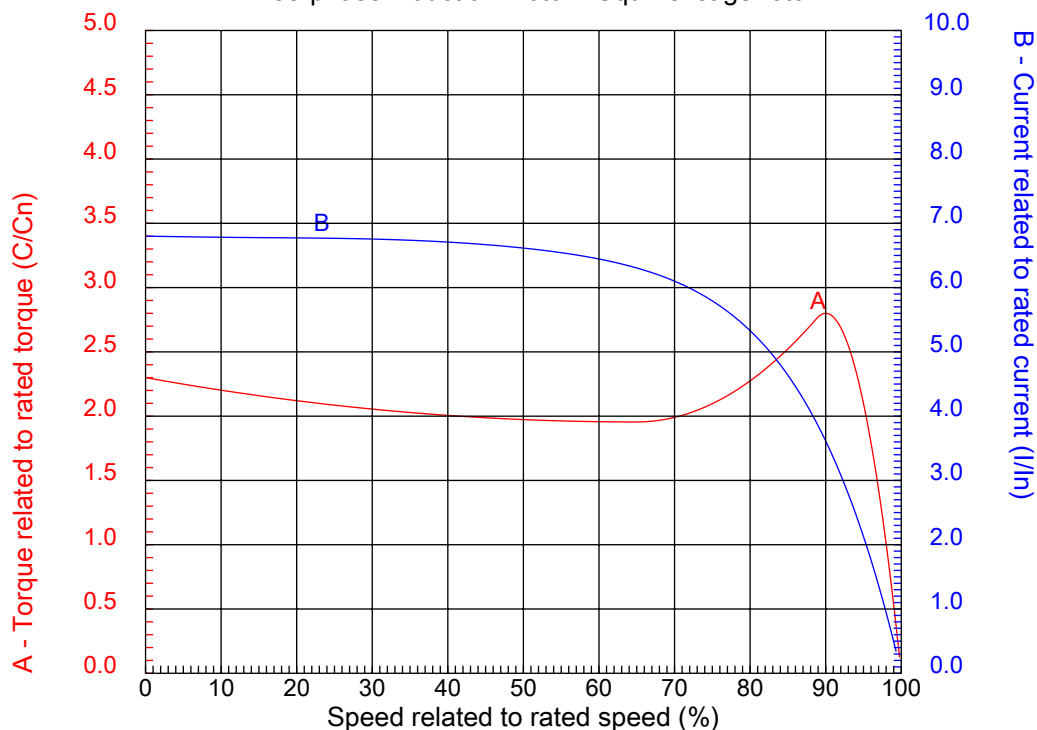

Customer :
Product line : W22 NEMA Premium - Ball Bearings

Frame	: 213/5T	Locked rotor current (I _l /I _n)	: 6.8
Output	: 3 HP	Duty cycle	: S1
Frequency	: 60 Hz	Service factor	: 1.25
Full load speed	: 865 rpm	Design	: B
Voltage	: 575 V	Locked rotor torque	: 230 %
Rated current	: 3.65 A	Breakdown torque	: 280 %
Insulation class	: F		

Notes:
Downloaded from <http://dealerselectric.com>
Generated for Model #00309ET3H215T-W22

Performed by

Checked

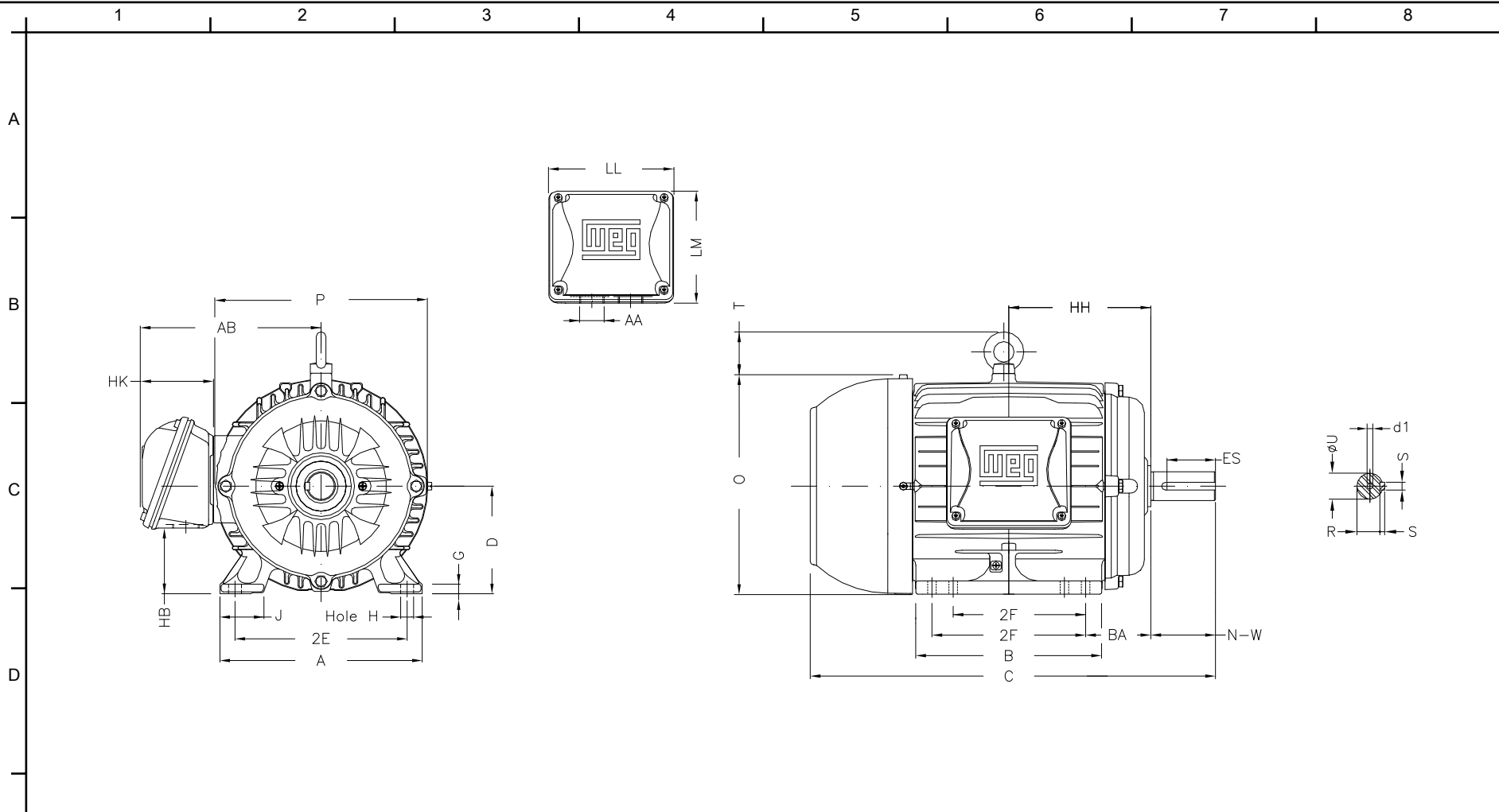

Notes: Downloaded from <http://dealerselectric.com>
 Generated for Model #00309ET3H215T-W22

2E 8.500	J 1.772	A 9.764	P 10.669	AB 8.583
2F 5.500/7.000	K 2.165	B 8.858	BA 3.500	FBA 5.921
U 1.375	N-W 3.375	ES 2.480	S 0.313	R 1.203
depth 0.313	D 5.250	G 0.669	HB 2.985	O 10.841
T 1.772	HF 5.250	HH 7.000	HK 3.150	EV 0.929
H 0.410	C 19.517	FC 22.546	LL 5.512	LM 5.236
AA NPT 1"	d1 A 4			

Performed by:
 Checked:
 Customer:
 W22 NEMA Premium - Ball Bearings
 Three-phase induction motor
 Frame 213/5T - IP55
 12-SEP-2016

1 2 3 4 5 6 7 8

A

B

C

D

E

F



Notes: Downloaded from <http://dealerselectric.com>
Generated for Model #00309ET3H215T-W22

Performed by:

Checked:

Customer:

W22 NEMA Premium - Ball Bearings

Three-phase induction motor
Frame 213/5T - IP55

12-SEP-2016

