



Dealers Industrial Equipment

No.:

Date: 12-SEP-2016

Customer :

TECHNICAL PROPOSAL

Three-phase induction motor - Squirrel cage rotor

Product line : W01 (Rolled Steel) General Purpose ODP

Catalog Number : 00236OT3E145T-SG

List Price : \$627

Notes:

Downloaded from <http://dealerselectric.com>

Generated for Model #00236OT3E145T-SG

Performed by:

Checked:



Dealers Industrial Equipment

No.:

Date: 12-SEP-2016

DATA SHEET Three-phase induction motor - Squirrel cage rotor

Customer :
 Product line : W01 (Rolled Steel) General Purpose ODP

Frame : 143/5T
 Output : 2 HP
 Frequency : 60 Hz
 Poles : 2
 Full load speed : 3510 rpm
 Slip : 2.50 %
 Voltage : 208-230/460 V
 Rated current : 5.35-4.84/2.42 A
 Locked rotor current : 43.1/21.5 A
 Locked rotor current (I_L/I_n) : 8.9
 No-load current : 1.83/0.917 A
 Full load torque : 2.95 lb.ft
 Locked rotor torque : 220 %
 Breakdown torque : 330 %
 Design : B
 Insulation class : F
 Temperature rise : 80 K
 Locked rotor time : 14 s (hot)
 Service factor : 1.15
 Duty cycle : S1
 Ambient temperature : -20°C - +40°C
 Altitude : 1000 m
 Degree of Protection : ODP
 Approximate weight : 37 lb
 Moment of inertia : 0.11509 sq.ft.lb
 Noise level : 62 dB(A)

	D.E.	N.D.E.
Bearings	6205 ZZ	6203 ZZ
Regreasing interval	---	---
Grease amount	---	---

Load	Power factor	Efficiency (%)
100%	0.91	85.5
75%	0.86	85.5
50%	0.77	84.0

Notes:
 Downloaded from <http://dealerselectric.com>
 Generated for Model #00236OT3E145T-SG

Performed by

Checked



Dealers Industrial Equipment

No.:

Date: 12-SEP-2016

PERFORMANCE CURVES RELATED TO RATED OUTPUT

Three-phase induction motor - Squirrel cage rotor

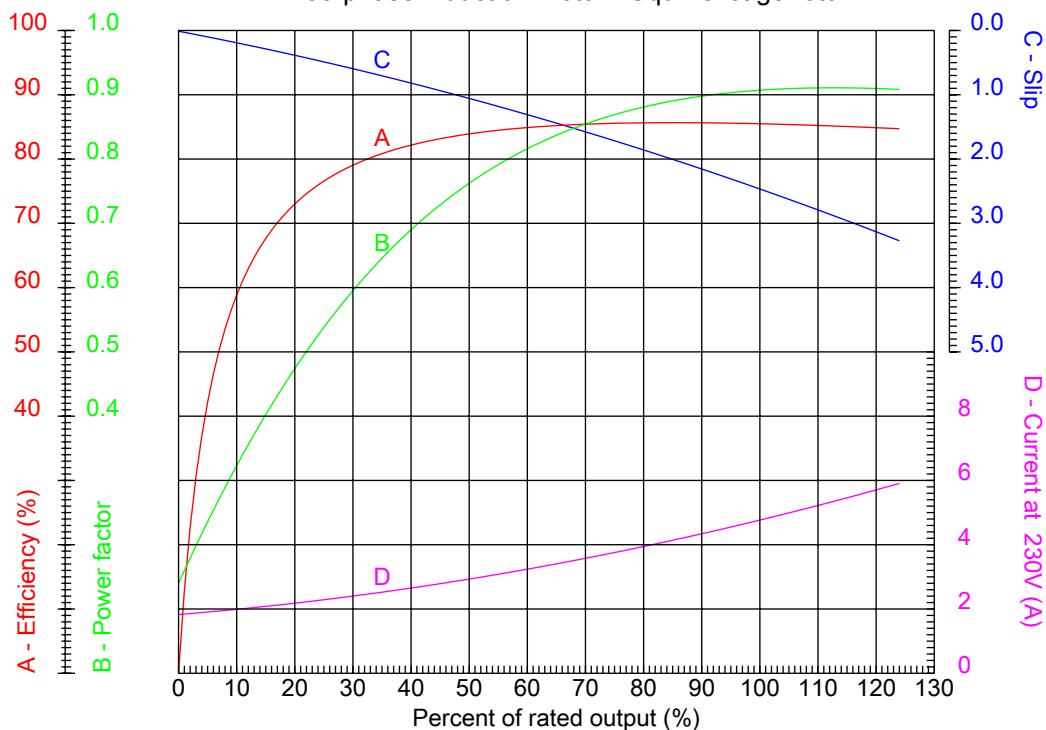

Customer :
Product line : W01 (Rolled Steel) General Purpose ODP

Frame	: 143/5T	Locked rotor current (I _l /I _n)	: 8.9
Output	: 2 HP	Duty cycle	: S1
Frequency	: 60 Hz	Service factor	: 1.15
Full load speed	: 3510 rpm	Design	: B
Voltage	: 208-230/460 V	Locked rotor torque	: 220 %
Rated current	: 5.35-4.84/2.42 A	Breakdown torque	: 330 %
Insulation class	: F		

Notes:
Downloaded from <http://dealerselectric.com>
Generated for Model #00236OT3E145T-SG

Performed by

Checked



Dealers Industrial Equipment

No.:

Date: 12-SEP-2016

CHARACTERISTIC CURVES RELATED TO SPEED

Three-phase induction motor - Squirrel cage rotor

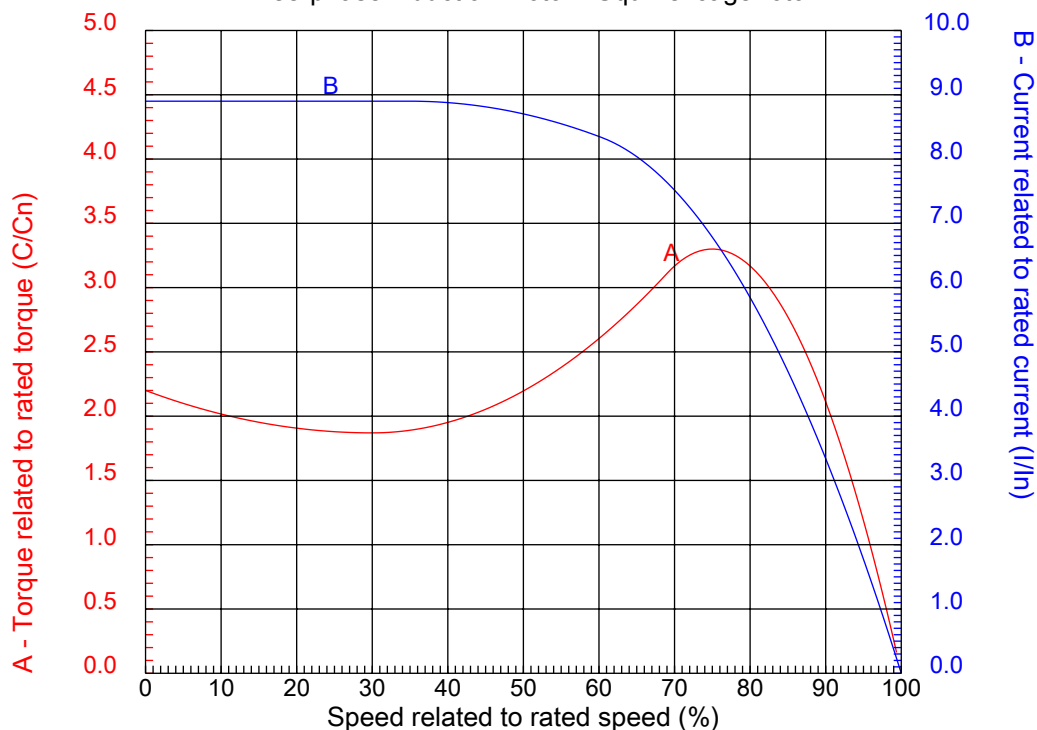

Customer :
Product line : W01 (Rolled Steel) General Purpose ODP

Frame	: 143/5T	Locked rotor current (I _l /I _n)	: 8.9
Output	: 2 HP	Duty cycle	: S1
Frequency	: 60 Hz	Service factor	: 1.15
Full load speed	: 3510 rpm	Design	: B
Voltage	: 208-230/460 V	Locked rotor torque	: 220 %
Rated current	: 5.35-4.84/2.42 A	Breakdown torque	: 330 %
Insulation class	: F		

Notes:
Downloaded from <http://dealerselectric.com>
Generated for Model #00236OT3E145T-SG

Performed by

Checked

1 2 3 4 5 6 7 8

A
B
C
D
E
F

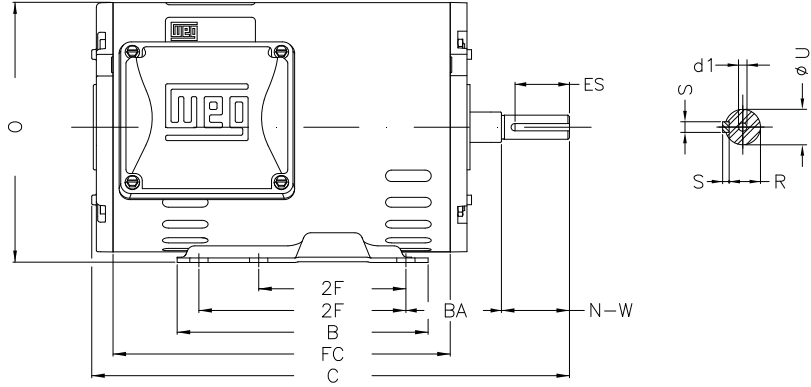
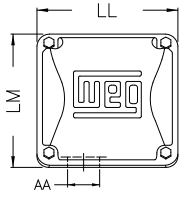
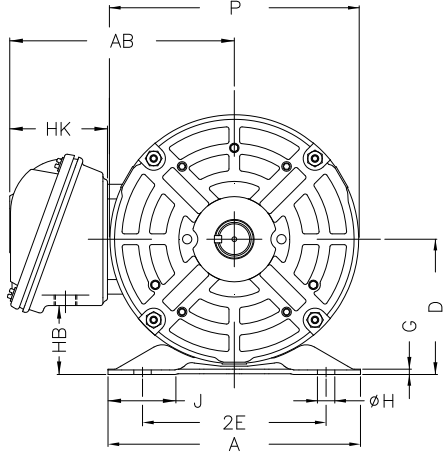

Notes: Downloaded from <http://dealerselectric.com>
Generated for Model #002360T3E145T-SG

Performed by:

Checked:

Customer:

W01 (Rolled Steel) General Purpose ODP

Three-phase induction motor

Frame 143/5T - ODP

12-SEP-2016



P	AB	J	2E	A
6.456	5.882	1.732	5.500	6.535
H	G	HB	HK	T
0.343	0.120	1.783	2.638	0.004
O	FC	2F	B	C
6.724	8.268	4.000/5.000	6.496	11.969
BA	N-W	ES	d1	S
2.250	2.250	1.417	A 3,15	0.187
U	AA	depth	R	LL
0.875	1.118"	0.187	0.771	4.543
LM	BB	D	CH	
4.106	0.004	3.500	1.377	

1 2 3 4 5 6 7 8

A

LOW VOLTAGE

HIGH VOLTAGE

B



C



D

E

F

Notes: Downloaded from <http://dealerselectric.com>
 Generated for Model #00236OT3E145T-SG

Performed by:

Checked:

Customer:

W01 (Rolled Steel) General Purpose ODP

Three-phase induction motor
 Frame 143/5T - IP21

12-SEP-2016

