



Dealers Industrial Equipment

No.:

Date: 12-SEP-2016

Customer :

TECHNICAL PROPOSAL

Three-phase induction motor - Squirrel cage rotor

Product line : Jet Pump - NEMA 56 : Three-Phase - Threaded - ODP (IP21)

Catalog Number : 00236OS3EJP56J

List Price : \$316

Notes:

Downloaded from <http://dealerselectric.com>

Generated for Model #00236OS3EJP56J

Performed by:

Checked:



Dealers Industrial Equipment

No.:

Date: 12-SEP-2016

DATA SHEET Three-phase induction motor - Squirrel cage rotor

Customer :
 Product line : Jet Pump - NEMA 56 : Three-Phase - Threaded - ODP (IP21)

Frame : D56
 Output : 2 HP
 Frequency : 60 Hz
 Poles : 2
 Full load speed : 3460 rpm
 Slip : 3.89 %
 Voltage : 208-230/460 V
 Rated current : 5.70-5.36/2.68 A
 Locked rotor current : 43.4/21.7 A
 Locked rotor current (I_L/I_n) : 8.1
 No-load current : 2.58/1.29 A
 Full load torque : 2.99 lb.ft
 Locked rotor torque : 330 %
 Breakdown torque : 340 %
 Design : A
 Insulation class : B
 Temperature rise : 80 K
 Locked rotor time : 10 s (hot)
 Service factor : 1.20 (1.00 at 208V)
 Duty cycle : S1
 Ambient temperature : -20°C - +40°C
 Altitude : 1000 m
 Degree of Protection : IP21
 Approximate weight : 39 lb
 Moment of inertia : 0.04129 sq.ft.lb
 Noise level : ---

	D.E.	N.D.E.
Bearings	6204 2RS	6202 2RS
Regreasing interval	---	---
Grease amount	---	---

Load	Power factor	Efficiency (%)
100%	0.87	81.0
75%	0.80	80.5
50%	0.68	78.0

Notes:
 Downloaded from <http://dealerselectric.com>
 Generated for Model #00236OS3EJP56J

Performed by

Checked



Dealers Industrial Equipment

No.:

Date: 12-SEP-2016

PERFORMANCE CURVES RELATED TO RATED OUTPUT

Three-phase induction motor - Squirrel cage rotor

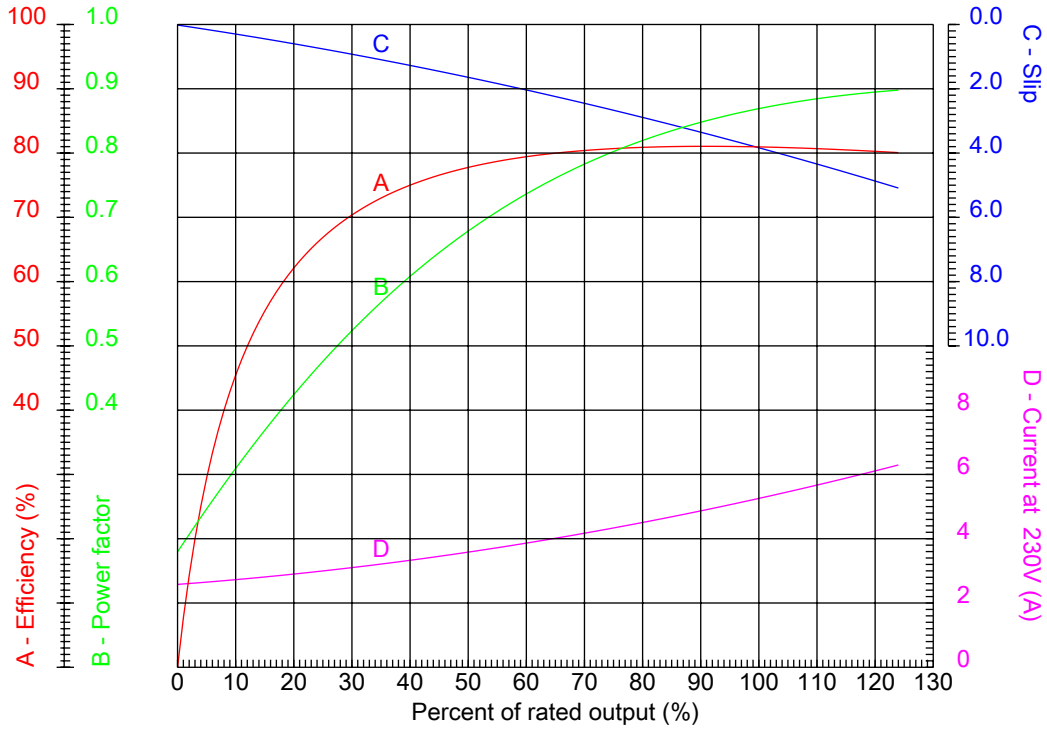

Customer :
 Product line : Jet Pump - NEMA 56 : Three-Phase - Threaded - ODP (IP21)

Frame : D56	Locked rotor current (I _L /I _n) : 8.1
Output : 2 HP	Duty cycle : S1
Frequency : 60 Hz	Service factor : 1.20 (1.00 at 208V)
Full load speed : 3460 rpm	Design : A
Voltage : 208-230/460 V	Locked rotor torque : 330 %
Rated current : 5.70-5.36/2.68 A	Breakdown torque : 340 %
Insulation class : B	

Notes:
 Downloaded from <http://dealerselectric.com>
 Generated for Model #00236OS3EJP56J

Performed by

Checked



Dealers Industrial Equipment

No.:

Date: 12-SEP-2016

CHARACTERISTIC CURVES RELATED TO SPEED

Three-phase induction motor - Squirrel cage rotor

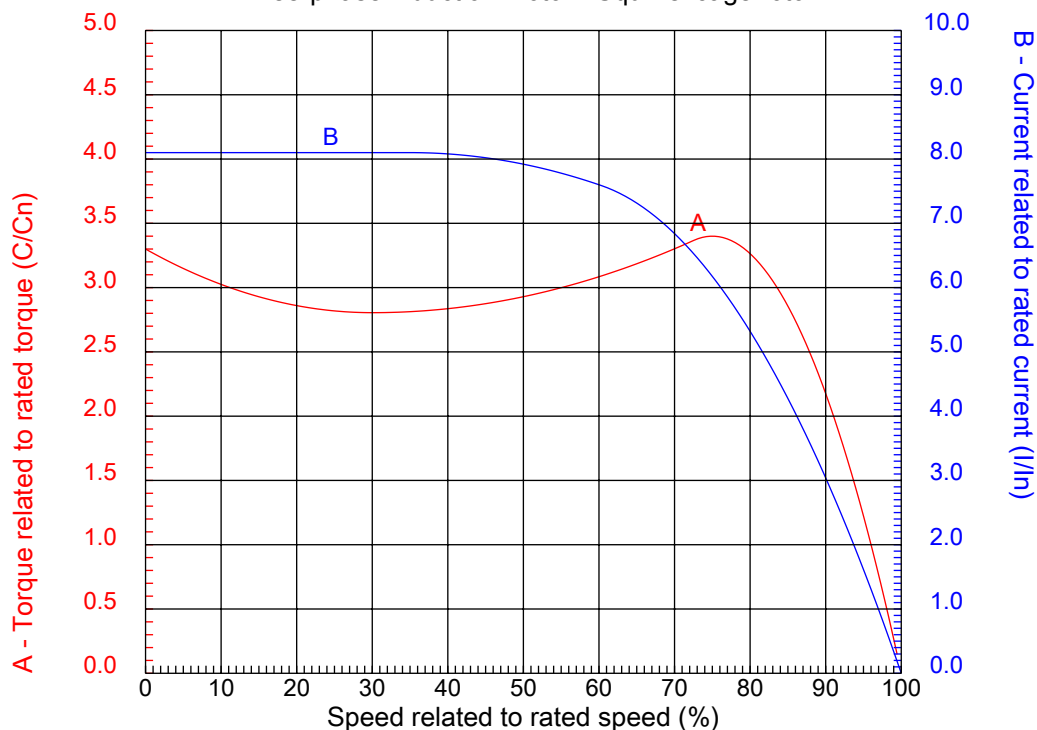

Customer :
Product line : Jet Pump - NEMA 56 : Three-Phase - Threaded - ODP (IP21)

Frame	: D56	Locked rotor current (I _l /I _n)	: 8.1
Output	: 2 HP	Duty cycle	: S1
Frequency	: 60 Hz	Service factor	: 1.20 (1.00 at 208V)
Full load speed	: 3460 rpm	Design	: A
Voltage	: 208-230/460 V	Locked rotor torque	: 330 %
Rated current	: 5.70-5.36/2.68 A	Breakdown torque	: 340 %
Insulation class	: B		

Notes:
Downloaded from <http://dealerselectric.com>
Generated for Model #00236OS3EJP56J

Performed by

Checked

1 2 3 4 5 6 7 8

A

B

C

D

E

F

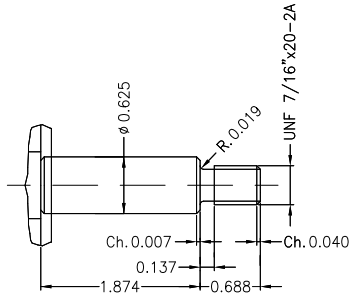
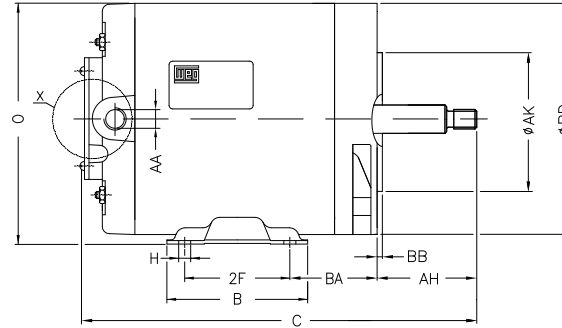
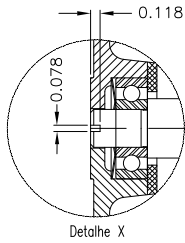
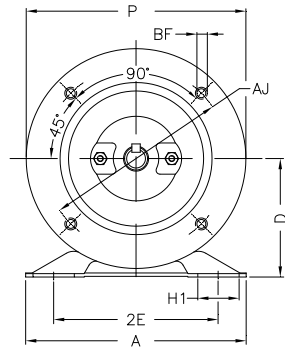

THREE-PHASE, FORM J, WITH INTERNAL THREAD OF 1/4x28 UNF AT SHAFT-END, FOR CLAMPING THE PUMP ROTOR.

Notes: Downloaded from <http://dealerselectric.com>
Generated for Model #00236OS3EJP56J

Performed by:

Checked:

Customer:

Jet Pump - NEMA 56 : Three-Phase - Threaded - ODP (IP21)

Three-phase induction motor
Frame D56 - IP21

12-SEP-2016



2E 4.874	2F 3.000	BA 2.748	A 6.535	B 4.016
C 12.972	D 3.500	G 0.120	O 6.772	P 6.496
N-W 1.874	U 0.625	AA NPT 1/2"	Flange FC-149	AJ 5.874
AK 4.500	BD 6.535	BF 114.3	BB 0.157	AH 2.563

1 2 3 4 5 6 7 8

A

LOW VOLTAGE

HIGH VOLTAGE

B

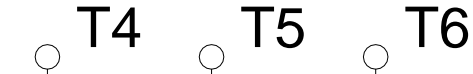
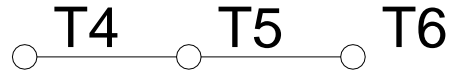

C

L1 L2 L3

L1 L2 L3

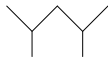

D

E

F

Notes: Downloaded from <http://dealerselectric.com>
 Generated for Model #00236OS3EJP56J

Performed by:

Checked:

Customer:

Jet Pump - NEMA 56 : Three-Phase - Threaded - ODP (IP21)

Three-phase induction motor
 Frame D56 - IP21

12-SEP-2016

