



Dealers Industrial Equipment

No.:

Date: 12-SEP-2016

Customer :

TECHNICAL PROPOSAL

Three-phase induction motor - Squirrel cage rotor

Product line : Three-Phase : Explosion Proof - NEMA Premium

Catalog Number : 00218XT3H145T

List Price : \$995

Notes:

Downloaded from <http://dealerselectric.com>

Generated for Model #00218XT3H145T

Performed by:

Checked:



# Dealers Industrial Equipment

No.:

Date: 12-SEP-2016

## DATA SHEET Three-phase induction motor - Squirrel cage rotor

Customer :  
 Product line : Three-Phase : Explosion Proof - NEMA Premium

Frame : 145T  
 Output : 2 HP  
 Frequency : 60 Hz  
 Poles : 4  
 Full load speed : 1750 rpm  
 Slip : 2.78 %  
 Voltage : 575 V  
 Rated current : 2.18 A  
 Locked rotor current : 17.2 A  
 Locked rotor current (I<sub>L</sub>/I<sub>n</sub>) : 7.9  
 No-load current : 1.20 A  
 Full load torque : 5.92 lb.ft  
 Locked rotor torque : 250 %  
 Breakdown torque : 320 %  
 Design : B  
 Insulation class : F  
 Temperature rise : 80 K  
 Locked rotor time : 11 s (hot)  
 Service factor : 1.15  
 Duty cycle : S1  
 Ambient temperature : -20°C - +40°C  
 Altitude : 1000 m  
 Degree of Protection : IP55  
 Approximate weight : 73 lb  
 Moment of inertia : 0.15947 sq.ft.lb  
 Noise level : 51 dB(A)

	D.E.	N.D.E.
Bearings	6205 2RS	6204 2RS
Regreasing interval	---	---
Grease amount	---	---

Load	Power factor	Efficiency (%)
100%	0.80	86.5
75%	0.73	85.5
50%	0.60	84.0

Notes:  
 Downloaded from <http://dealerselectric.com>  
 Generated for Model #00218XT3H145T

Performed by

Checked



# Dealers Industrial Equipment

No.:

Date: 12-SEP-2016

## PERFORMANCE CURVES RELATED TO RATED OUTPUT

Three-phase induction motor - Squirrel cage rotor

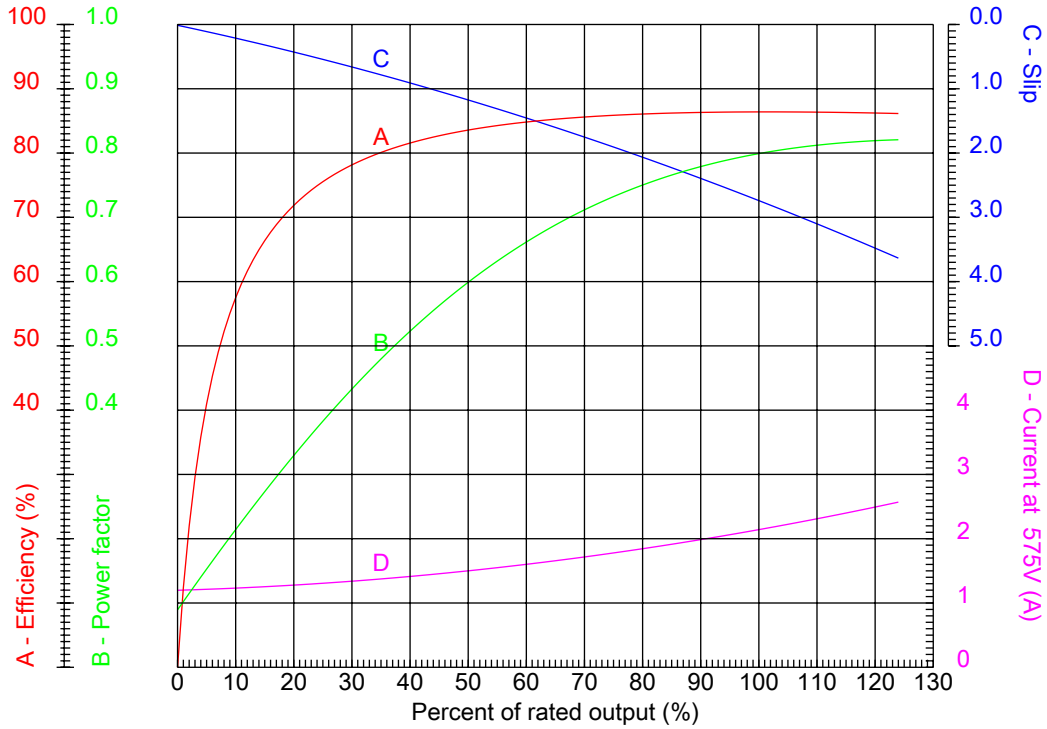

Customer :  
 Product line : Three-Phase : Explosion Proof - NEMA Premium

Frame	: 145T	Locked rotor current (I <sub>L</sub> /I <sub>n</sub> )	: 7.9
Output	: 2 HP	Duty cycle	: S1
Frequency	: 60 Hz	Service factor	: 1.15
Full load speed	: 1750 rpm	Design	: B
Voltage	: 575 V	Locked rotor torque	: 250 %
Rated current	: 2.18 A	Breakdown torque	: 320 %
Insulation class	: F		

Notes:  
 Downloaded from <http://dealerselectric.com>  
 Generated for Model #00218XT3H145T

Performed by

Checked



# Dealers Industrial Equipment

No.:

Date: 12-SEP-2016

## CHARACTERISTIC CURVES RELATED TO SPEED

Three-phase induction motor - Squirrel cage rotor

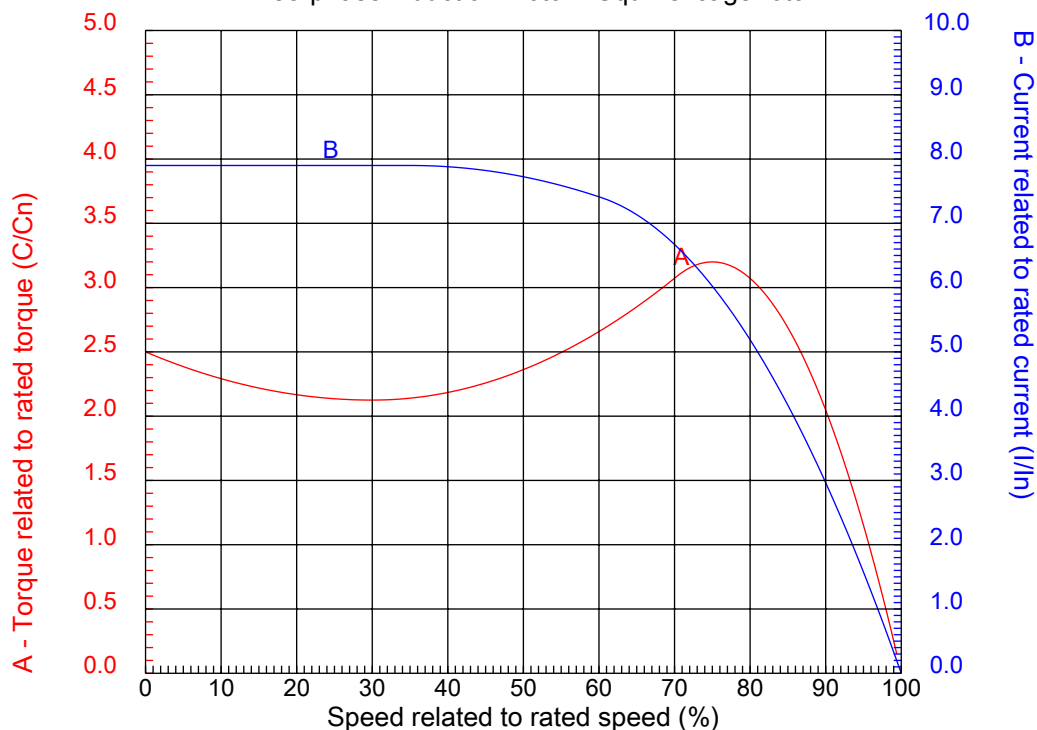

Customer :  
Product line : Three-Phase : Explosion Proof - NEMA Premium

Frame	: 145T	Locked rotor current (I <sub>l</sub> /I <sub>n</sub> )	: 7.9
Output	: 2 HP	Duty cycle	: S1
Frequency	: 60 Hz	Service factor	: 1.15
Full load speed	: 1750 rpm	Design	: B
Voltage	: 575 V	Locked rotor torque	: 250 %
Rated current	: 2.18 A	Breakdown torque	: 320 %
Insulation class	: F		

Notes:  
Downloaded from <http://dealerselectric.com>  
Generated for Model #00218XT3H145T

Performed by

Checked

1 2 3 4 5 6 7 8

A

B

C

D

E

F

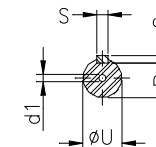
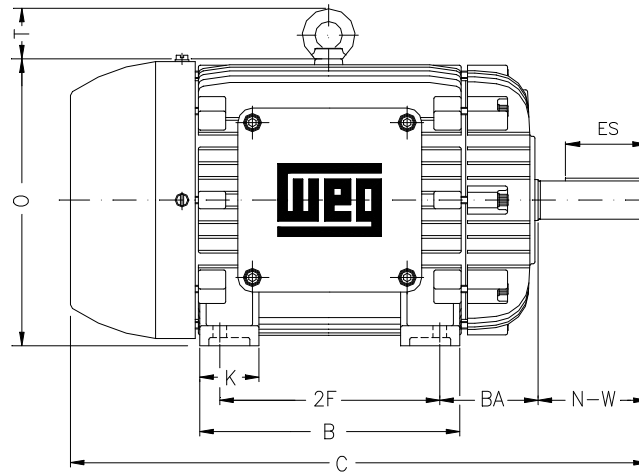
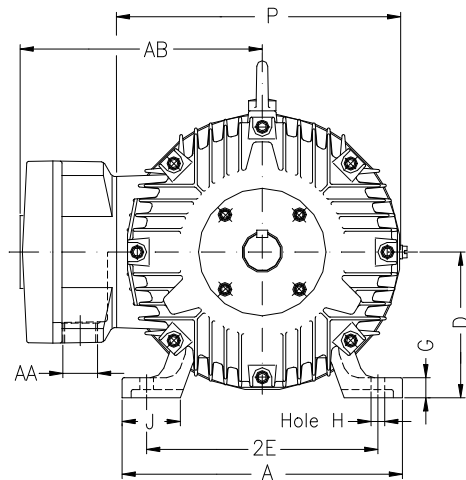

Notes: Downloaded from <http://dealerselectric.com>  
Generated for Model #00218XT3H145T

Performed by:

Checked:

Customer:

Three-Phase : Explosion Proof - NEMA Premium

Three-phase induction motor  
Frame 145T - IP55

12-SEP-2016



2E 5.500	A 6.457	2F 5.000	B 6.142	BA 2.250
J 1.496	K 1.654	P 7.000	ES 1.575	depth 0.187
S 0.187	N-W 2.250	U 0.875	R 0.771	AB 6.811
D 3.500	G 0.429	O 7.000	T 0.000	H 0.344
C 13.752	AA NPT 3/4"	d1 A 4	d2 A 4	

1 2 3 4 5 6 7 8

A  
B  
C  
D  
E  
F

### RUN

### ONLY FOR START



Notes: Downloaded from <a href="http://dealerselectric.com">http://dealerselectric.com</a> Generated for Model #00218XT3H145T		
Performed by:		
Checked:		
Customer:		
Three-Phase : Explosion Proof - NEMA Premium		
Three-phase induction motor Frame 145T - IP55	12-SEP-2016	