



Dealers Industrial Equipment

No.:

Date: 12-SEP-2016

Customer :

TECHNICAL PROPOSAL

Three-phase induction motor - Squirrel cage rotor

Product line : Three-Phase: W22 IEEE-841™ Petrochem Motors - NEMA Premium® Efficiency

Catalog Number : 00218ST3QIE145T-W22

List Price : \$1,023

Notes:

Downloaded from <http://dealerselectric.com>

Generated for Model #00218ST3QIE145T-W22

Performed by:

Checked:



Dealers Industrial Equipment

No.:

Date: 12-SEP-2016

DATA SHEET

Three-phase induction motor - Squirrel cage rotor

Customer :
 Product line : Three-Phase: W22 IEEE-841™ Petrochem Motors - NEMA Premium® Efficiency

Frame : 143/5T
 Output : 2 HP
 Frequency : 60 Hz
 Poles : 4
 Full load speed : 1750 rpm
 Slip : 2.78 %
 Voltage : 460 V
 Rated current : 2.76 A
 Locked rotor current : 22.1 A
 Locked rotor current (I_L/I_n) : 8.0
 No-load current : 1.50 A
 Full load torque : 5.92 lb.ft
 Locked rotor torque : 270 %
 Breakdown torque : 320 %
 Design : B
 Insulation class : F
 Temperature rise : 80 K
 Locked rotor time : 11 s (hot)
 Service factor : 1.25
 Duty cycle : S1
 Ambient temperature : -20°C - +40°C
 Altitude : 1000 m
 Degree of Protection : IP55
 Approximate weight : 51 lb
 Moment of inertia : 0.15614 sq.ft.lb
 Noise level : 51 dB(A)

	D.E.	N.D.E.
Bearings	6205 C3	6204 C3
Regreasing interval	20000 h	20000 h
Grease amount	4 g	4 g

Load	Power factor	Efficiency (%)
100%	0.79	86.5
75%	0.70	86.5
50%	0.57	85.5

Notes:
 Downloaded from <http://dealerselectric.com>
 Generated for Model #00218ST3QIE145T-W22

Performed by

Checked



Dealers Industrial Equipment

No.:

Date: 12-SEP-2016

PERFORMANCE CURVES RELATED TO RATED OUTPUT

Three-phase induction motor - Squirrel cage rotor

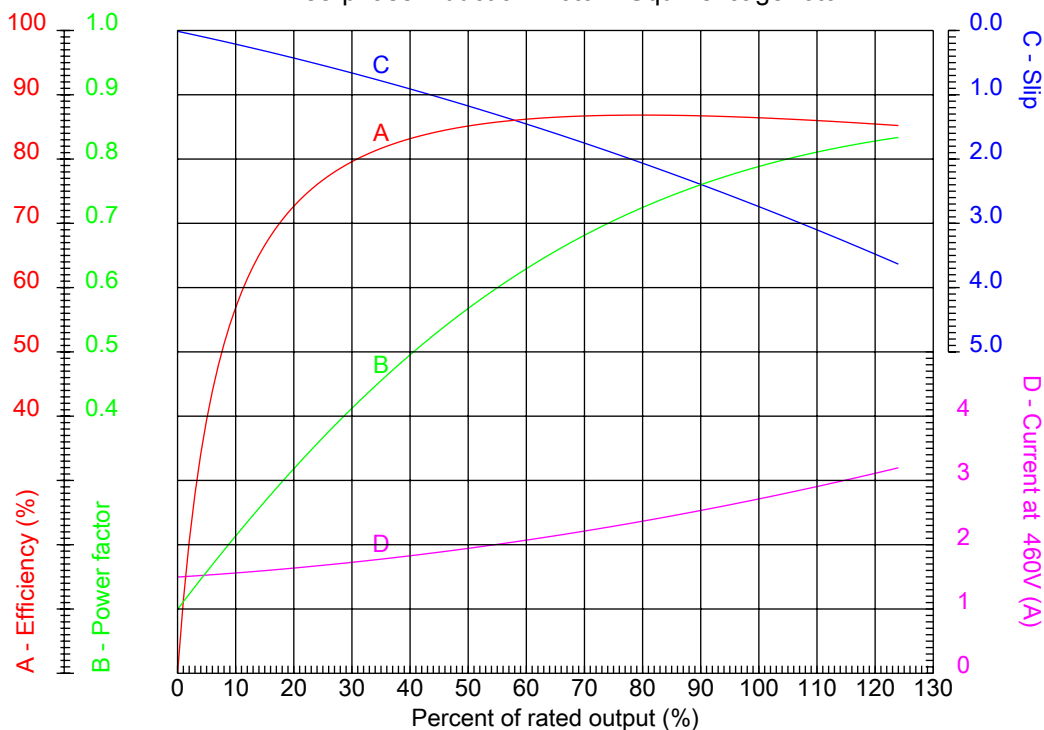

Customer :
 Product line : Three-Phase: W22 IEEE-841™ Petrochem Motors - NEMA Premium® Efficiency

Frame	: 143/5T	Locked rotor current (I _L /I _n)	: 8.0
Output	: 2 HP	Duty cycle	: S1
Frequency	: 60 Hz	Service factor	: 1.25
Full load speed	: 1750 rpm	Design	: B
Voltage	: 460 V	Locked rotor torque	: 270 %
Rated current	: 2.76 A	Breakdown torque	: 320 %
Insulation class	: F		

Notes:
 Downloaded from <http://dealerselectric.com>
 Generated for Model #00218ST3QIE145T-W22

Performed by

Checked



Dealers Industrial Equipment

No.:

Date: 12-SEP-2016

CHARACTERISTIC CURVES RELATED TO SPEED

Three-phase induction motor - Squirrel cage rotor

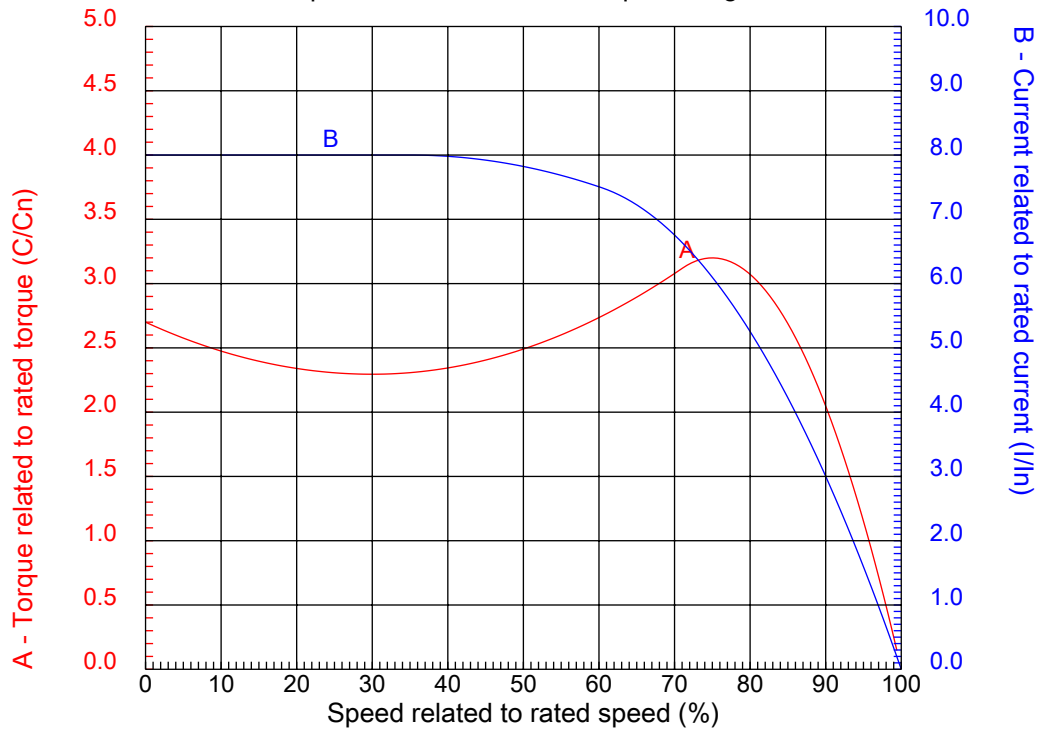

Customer :
Product line : Three-Phase: W22 IEEE-841™ Petrochem Motors - NEMA Premium® Efficiency

Frame	: 143/5T	Locked rotor current (I _L /I _n)	: 8.0
Output	: 2 HP	Duty cycle	: S1
Frequency	: 60 Hz	Service factor	: 1.25
Full load speed	: 1750 rpm	Design	: B
Voltage	: 460 V	Locked rotor torque	: 270 %
Rated current	: 2.76 A	Breakdown torque	: 320 %
Insulation class	: F		

Notes:
Downloaded from <http://dealerselectric.com>
Generated for Model #00218ST3QIE145T-W22

Performed by

Checked

1 2 3 4 5 6 7 8

A
B
C
D
E
F

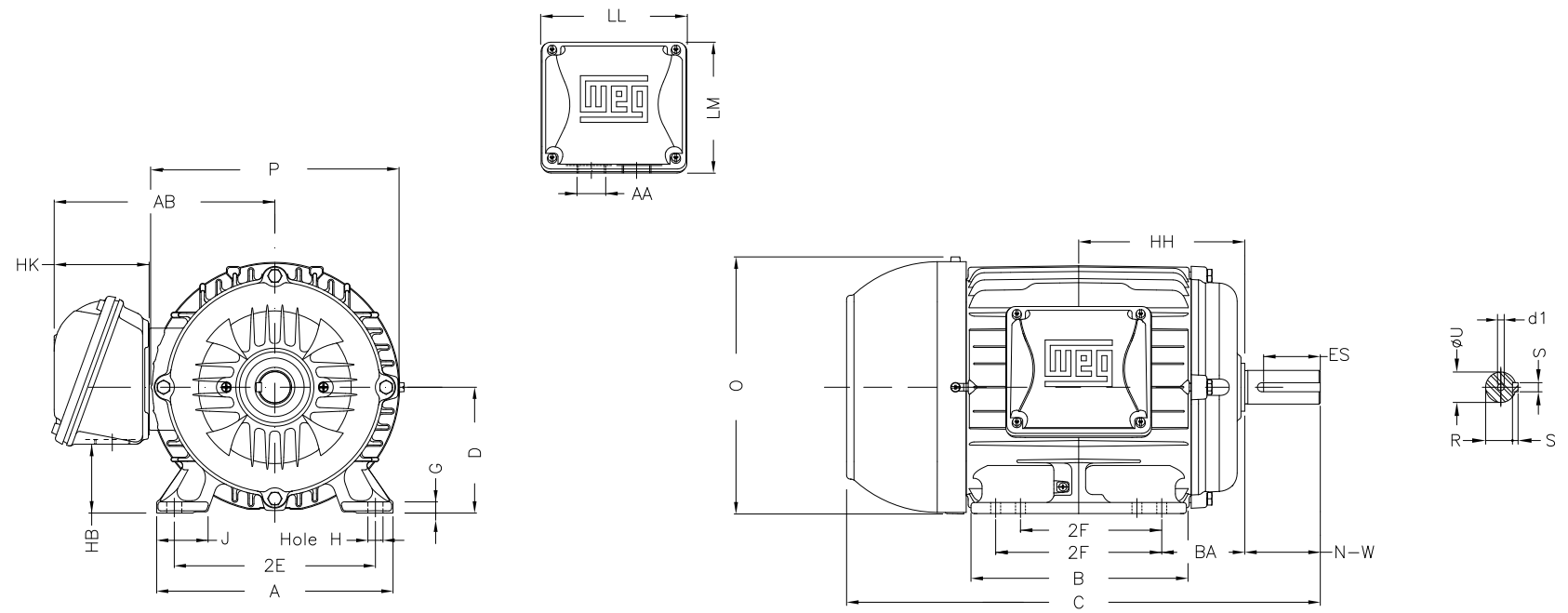

Notes: Downloaded from <http://dealerselectric.com>
Generated for Model #00218ST3QIE145T-W22

Performed by:

Checked:

Customer:

Three-Phase: W22 IEEE-841™ Petrochem Motors - NEMA Premium® Efficiency

2E 5.500	J 1.437	A 6.457	P 7.047	AB 6.260
2F 4.000/5.000	B 6.142	BA 2.250	U 0.875	N-W 2.250
ES 1.417	S 0.187	R 0.771	depth 0.187	D 3.500
G 0.354	HB 1.787	O 7.122	HF 3.500	HH 4.750
HK 2.638	H 0.344	C 13.346	LL 4.528	LM 4.094
AA NPT 3/4"	d1 A 4	d2 A 4		

Three-phase induction motor
Frame 143/5T - IP55

12-SEP-2016



1 2 3 4 5 6 7 8

A

B

C

D

E

F

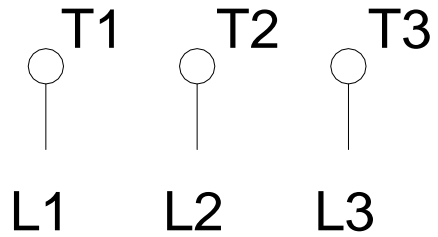

Notes: Downloaded from <http://dealerselectric.com>
Generated for Model #00218ST3QIE145T-W22

Performed by:

Checked:

Customer:

Three-Phase: W22 IEEE-841™ Petrochem Motors - NEMA Premium® Efficiency

Three-phase induction motor
Frame 143/5T - IP55

12-SEP-2016

