



Dealers Industrial Equipment

No.:

Date: 12-SEP-2016

Customer :

TECHNICAL PROPOSAL

Three-phase induction motor - Squirrel cage rotor

Product line : Three-Phase : Rolled Steel Motor - NEMA Premium Efficiency

Catalog Number : 00218ET3HRS145T

List Price : \$>(discontinued)

Notes:

Downloaded from <http://dealerselectric.com>

Generated for Model #00218ET3HRS145T

Performed by:

Checked:



Dealers Industrial Equipment

No.:

Date: 12-SEP-2016

DATA SHEET

Three-phase induction motor - Squirrel cage rotor

Customer :
 Product line : Three-Phase : Rolled Steel Motor - NEMA Premium Efficiency

Frame : 143/5T
 Output : 2 HP
 Frequency : 60 Hz
 Poles : 4
 Full load speed : 1750 rpm
 Slip : 2.78 %
 Voltage : 575 V
 Rated current : 2.28 A
 Locked rotor current : 19.8 A
 Locked rotor current (I_L/I_n) : 8.7
 No-load current : 1.32 A
 Full load torque : 5.92 lb.ft
 Locked rotor torque : 390 %
 Breakdown torque : 390 %
 Design : B
 Insulation class : F
 Temperature rise : 80 K
 Locked rotor time : 15 s (hot)
 Service factor : 1.15
 Duty cycle : S1
 Ambient temperature : -20°C - +40°C
 Altitude : 1000 m
 Degree of Protection : IP55
 Approximate weight : 42 lb
 Moment of inertia : 0.17750 sq.ft.lb
 Noise level : ---

	D.E.	N.D.E.
Bearings	6205 ZZ	6203 ZZ
Regreasing interval	---	---
Grease amount	---	---

Load	Power factor	Efficiency (%)
100%	0.77	86.5
75%	0.69	85.5
50%	0.56	81.5

Notes:
 Downloaded from <http://dealerselectric.com>
 Generated for Model #00218ET3HRS145T

Performed by

Checked



Dealers Industrial Equipment

No.:

Date: 12-SEP-2016

PERFORMANCE CURVES RELATED TO RATED OUTPUT

Three-phase induction motor - Squirrel cage rotor

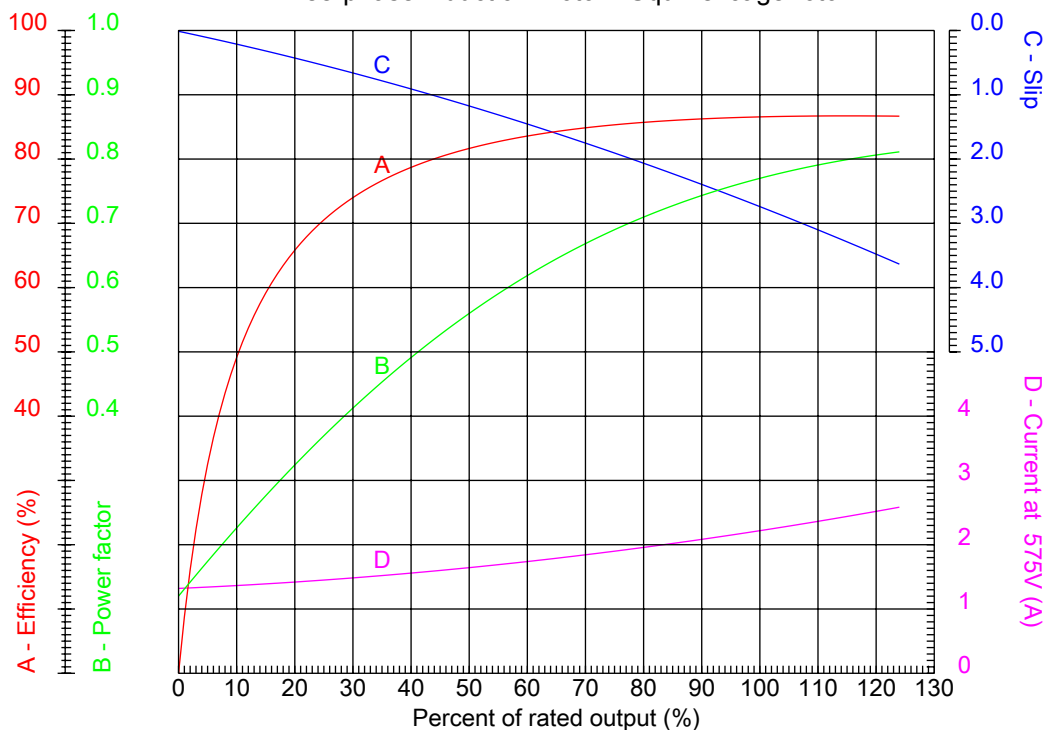

Customer :
Product line : Three-Phase : Rolled Steel Motor - NEMA Premium Efficiency

Frame : 143/5T	Locked rotor current (I _l /I _n) : 8.7
Output : 2 HP	Duty cycle : S1
Frequency : 60 Hz	Service factor : 1.15
Full load speed : 1750 rpm	Design : B
Voltage : 575 V	Locked rotor torque : 390 %
Rated current : 2.28 A	Breakdown torque : 390 %
Insulation class : F	

Notes:
Downloaded from <http://dealerselectric.com>
Generated for Model #00218ET3HRS145T

Performed by

Checked



Dealers Industrial Equipment

No.:

Date: 12-SEP-2016

CHARACTERISTIC CURVES RELATED TO SPEED

Three-phase induction motor - Squirrel cage rotor

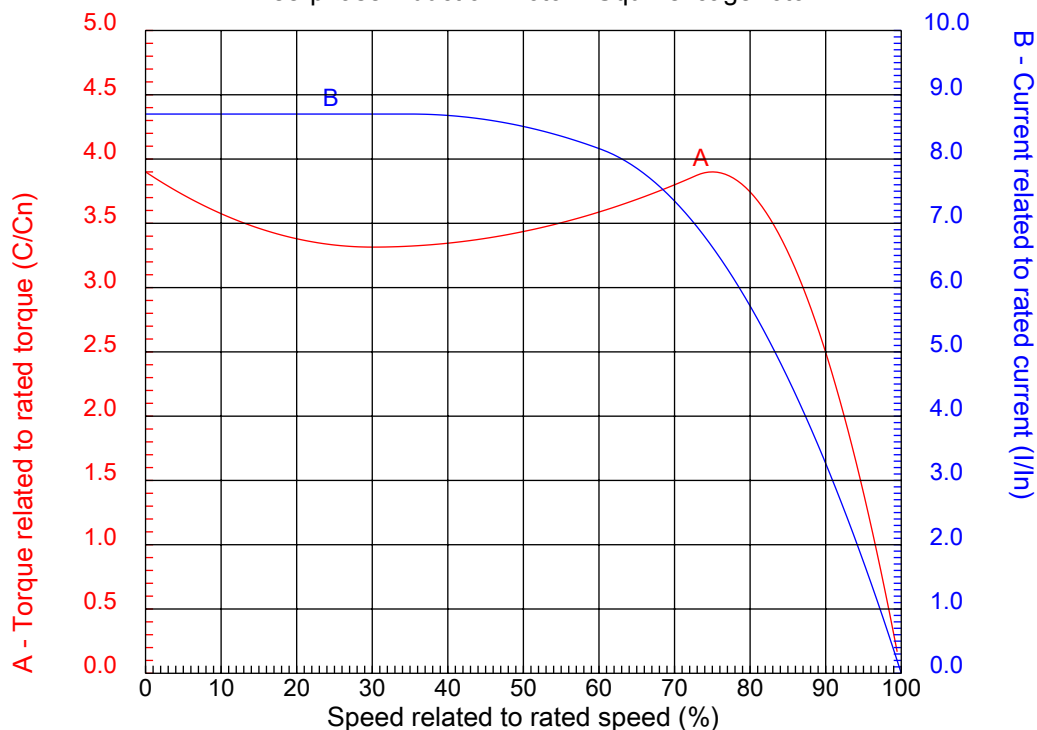

Customer :
Product line : Three-Phase : Rolled Steel Motor - NEMA Premium Efficiency

Frame	: 143/5T	Locked rotor current (I _l /I _n)	: 8.7
Output	: 2 HP	Duty cycle	: S1
Frequency	: 60 Hz	Service factor	: 1.15
Full load speed	: 1750 rpm	Design	: B
Voltage	: 575 V	Locked rotor torque	: 390 %
Rated current	: 2.28 A	Breakdown torque	: 390 %
Insulation class	: F		

Notes:
Downloaded from <http://dealerselectric.com>
Generated for Model #00218ET3HRS145T

Performed by

Checked

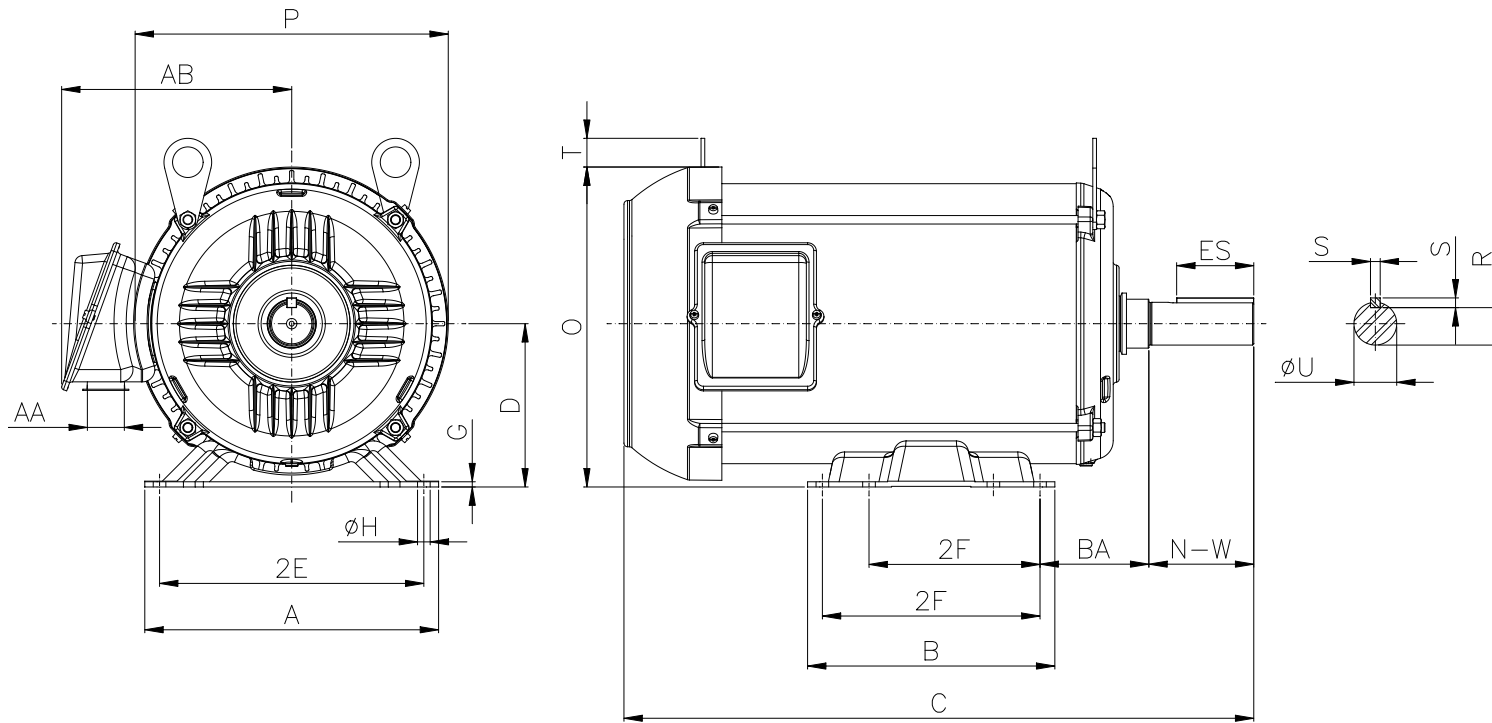

Notes: Downloaded from <http://dealerselectric.com>
 Generated for Model #00218ET3HRS145T

Performed by:

Checked:

Customer:

Three-Phase : Rolled Steel Motor - NEMA Premium Efficiency

Three-phase induction motor
 Frame 143/5T - IP55

12-SEP-2016



2E 5.500	J 1.732	A 6.535	P 7.323	2F 4.000/5.000
K 2.25	B 6.496	BA 2.250	U 0.8750	N-W 2.250
ES 1.417	S 0.187	R 0.766	depth 0.187	D 3.500
O 7.165	T 0.237	H 0.343	C 14.095	FC 7.874
d1 A 4	d2 DM6			

1 2 3 4 5 6 7 8

A
B
C
D
E
F

RUN

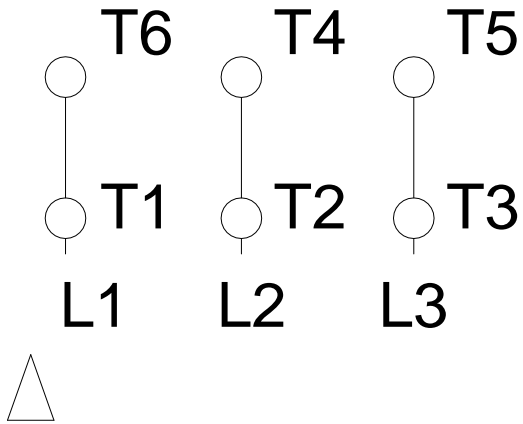

ONLY FOR START

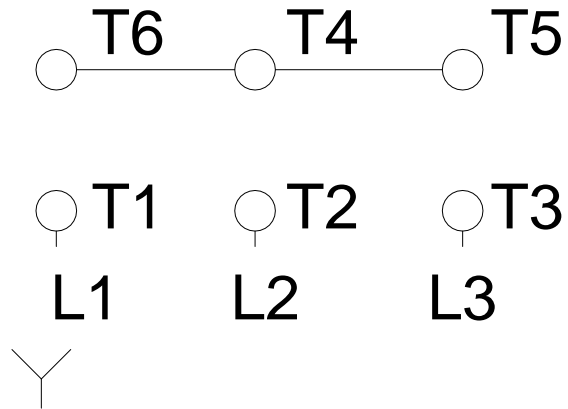

Notes: Downloaded from http://dealerselectric.com Generated for Model #00218ET3HRS145T		
Performed by:		
Checked:		
Customer:		
Three-Phase : Rolled Steel Motor - NEMA Premium Efficiency		
Three-phase induction motor Frame 143/5T - IP55	12-SEP-2016	