



Dealers Industrial Equipment

No.:

Date: 12-SEP-2016

Customer :

TECHNICAL PROPOSAL

Three-phase induction motor - Squirrel cage rotor

Product line : W22 Cooling Tower Motors: NEMA Premium - TEFC

Catalog Number : 00218ET3ECT145T-W22

List Price : \$752

Notes:

Downloaded from <http://dealerselectric.com>

Generated for Model #00218ET3ECT145T-W22

Performed by:

Checked:



Dealers Industrial Equipment

No.:

Date: 12-SEP-2016

DATA SHEET Three-phase induction motor - Squirrel cage rotor

Customer :
Product line : W22 Cooling Tower Motors: NEMA Premium - TEFC

Frame : 145T
Output : 2 HP
Frequency : 60 Hz
Poles : 4
Full load speed : 1750 rpm
Slip : 2.78 %
Voltage : 208-230/460 V
Rated current : 5.77-5.22/2.61 A
Locked rotor current : 39.2/19.6 A
Locked rotor current (I_L/I_n) : 7.5
No-load current : 2.48/1.24 A
Full load torque : 5.92 lb.ft
Locked rotor torque : 240 %
Breakdown torque : 300 %
Design : B
Insulation class : F
Temperature rise : 80 K
Locked rotor time : 11 s (hot)
Service factor : 1.25
Duty cycle : S1
Ambient temperature : -20°C - +40°C
Altitude : 1000 m
Degree of Protection : IP55
Approximate weight : 51 lb
Moment of inertia : 0.15614 sq.ft.lb
Noise level : 51 dB(A)

	D.E.	N.D.E.
Bearings	6205 ZZ	6204 ZZ
Regreasing interval	---	---
Grease amount	---	---

Load	Power factor	Efficiency (%)
100%	0.84	86.5
75%	0.78	86.5
50%	0.66	84.0

Notes:
Downloaded from <http://dealerselectric.com>
Generated for Model #00218ET3ECT145T-W22

Performed by

Checked



Dealers Industrial Equipment

No.:

Date: 12-SEP-2016

PERFORMANCE CURVES RELATED TO RATED OUTPUT

Three-phase induction motor - Squirrel cage rotor

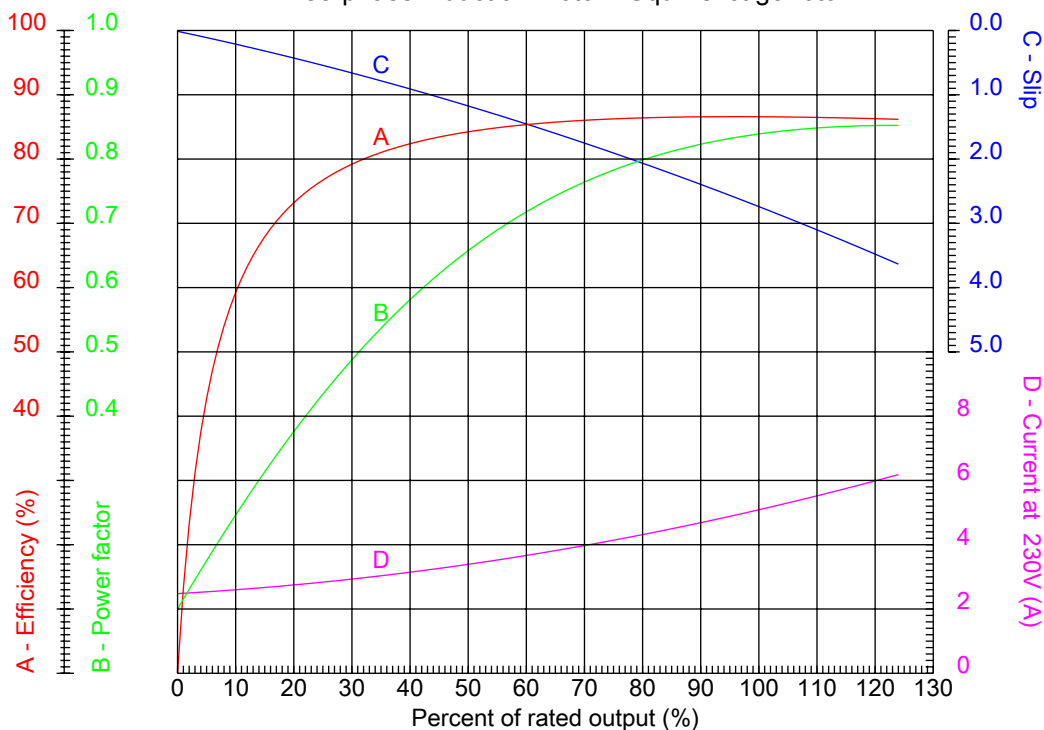

Customer :
 Product line : W22 Cooling Tower Motors: NEMA Premium - TEFC

Frame	: 145T	Locked rotor current (I _l /I _n)	: 7.5
Output	: 2 HP	Duty cycle	: S1
Frequency	: 60 Hz	Service factor	: 1.25
Full load speed	: 1750 rpm	Design	: B
Voltage	: 208-230/460 V	Locked rotor torque	: 240 %
Rated current	: 5.77-5.22/2.61 A	Breakdown torque	: 300 %
Insulation class	: F		

Notes:
 Downloaded from <http://dealerselectric.com>
 Generated for Model #00218ET3ECT145T-W22

Performed by

Checked



Dealers Industrial Equipment

No.:

Date: 12-SEP-2016

CHARACTERISTIC CURVES RELATED TO SPEED

Three-phase induction motor - Squirrel cage rotor

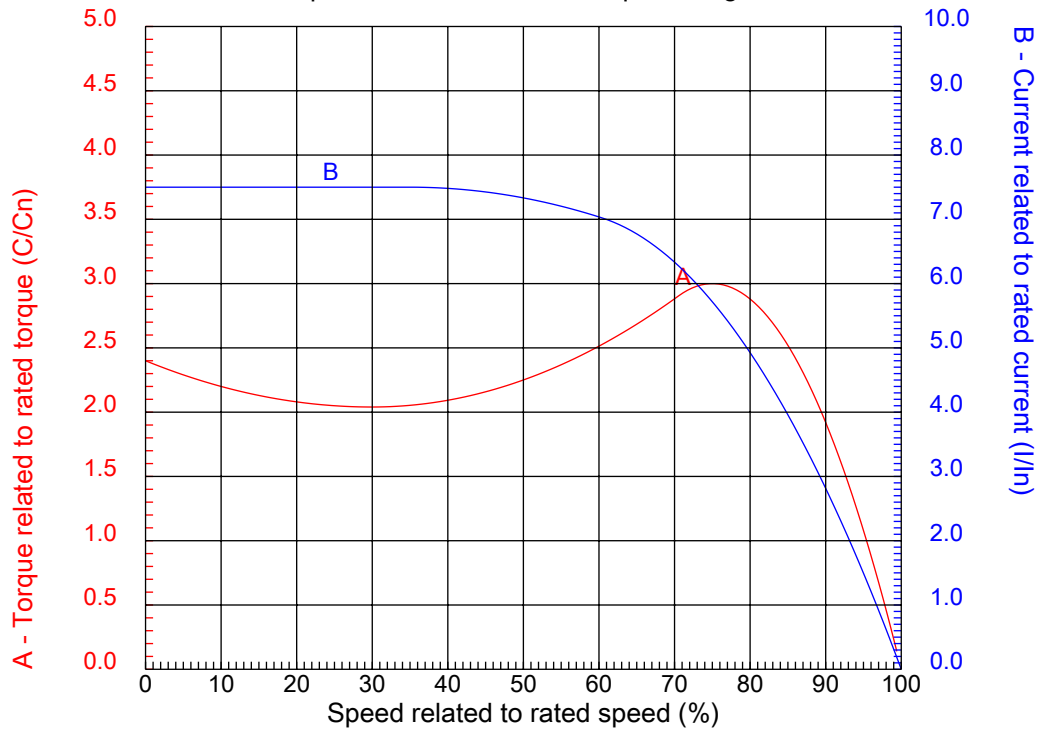

Customer :
Product line : W22 Cooling Tower Motors: NEMA Premium - TEFC

Frame	: 145T	Locked rotor current (I _l /I _n)	: 7.5
Output	: 2 HP	Duty cycle	: S1
Frequency	: 60 Hz	Service factor	: 1.25
Full load speed	: 1750 rpm	Design	: B
Voltage	: 208-230/460 V	Locked rotor torque	: 240 %
Rated current	: 5.77-5.22/2.61 A	Breakdown torque	: 300 %
Insulation class	: F		

Notes:
Downloaded from <http://dealerselectric.com>
Generated for Model #00218ET3ECT145T-W22

Performed by

Checked

1 2 3 4 5 6 7 8

A

B

C

D

E

F

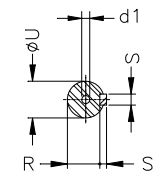
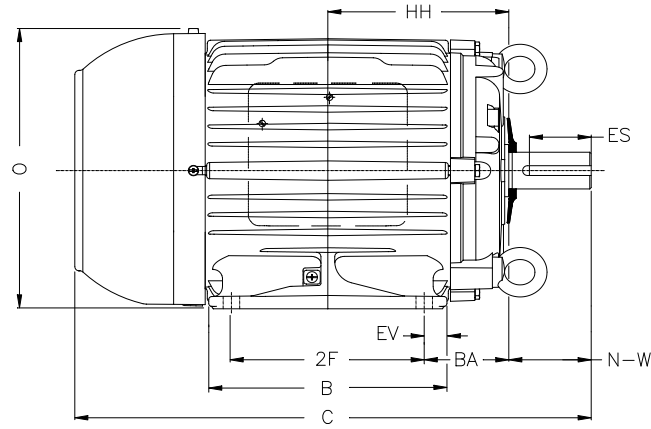
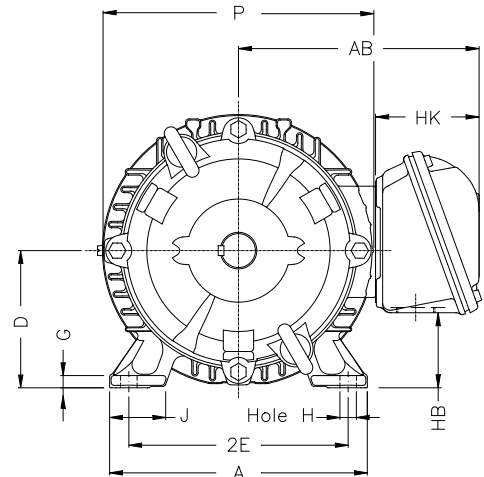
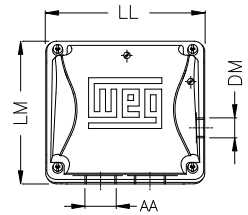

Notes: Downloaded from <http://dealerselectric.com>
Generated for Model #00218ET3ECT145T-W22

Performed by:

Checked:

Customer:

W22 Cooling Tower Motors: NEMA Premium - TEFC

Three-phase induction motor
Frame 145T - IP55

12-SEP-2016



2E 5.500	J 1.437	A 6.457	P 6.850	AB 6.260
2F 5.000	B 6.142	BA 2.250	U 0.875	N-W 2.250
ES 1.575	S 0.187	R 0.765	depth 0.187	D 3.500
G 0.354	HB 1.788	O 7.122	HF 3.500	HH 4.750
HK 2.717	H 0.344	C 13.346	LL 4.527	LM 4.094
AA NPT 3/4"	d1 A 4	d2 A 4		

1 2 3 4 5 6 7 8

A

LOW VOLTAGE

HIGH VOLTAGE

B



C



D

E

F

Notes: Downloaded from <http://dealerselectric.com>
 Generated for Model #00218ET3ECT145T-W22

Performed by:

Checked:

Customer:

W22 Cooling Tower Motors: NEMA Premium - TEFC

Three-phase induction motor
 Frame 145T - IP55

12-SEP-2016

