



Dealers Industrial Equipment

No.:

Date: 12-SEP-2016

Customer :

TECHNICAL PROPOSAL

Three-phase induction motor - Squirrel cage rotor

Product line : Three-Phase : Explosion Proof - NEMA Premium

Catalog Number : 00212XT3H184T

List Price : \$1,158

Notes:

Downloaded from <http://dealerselectric.com>

Generated for Model #00212XT3H184T

Performed by:

Checked:



Dealers Industrial Equipment

No.:

Date: 12-SEP-2016

DATA SHEET Three-phase induction motor - Squirrel cage rotor

Customer :
 Product line : Three-Phase : Explosion Proof - NEMA Premium

Frame : 184T
 Output : 2 HP
 Frequency : 60 Hz
 Poles : 6
 Full load speed : 1165 rpm
 Slip : 2.92 %
 Voltage : 575 V
 Rated current : 2.50 A
 Locked rotor current : 17.5 A
 Locked rotor current (I_L/I_n) : 7.0
 No-load current : 1.68 A
 Full load torque : 8.89 lb.ft
 Locked rotor torque : 260 %
 Breakdown torque : 330 %
 Design : B
 Insulation class : F
 Temperature rise : 80 K
 Locked rotor time : 35 s (hot)
 Service factor : 1.15
 Duty cycle : S1
 Ambient temperature : -20°C - +40°C
 Altitude : 1000 m
 Degree of Protection : IP55
 Approximate weight : 129 lb
 Moment of inertia : 0.53226 sq.ft.lb
 Noise level : 52 dB(A)

	D.E.	N.D.E.
Bearings	6307 2RS	6206 2RS
Regreasing interval	---	---
Grease amount	---	---

Load	Power factor	Efficiency (%)
100%	0.68	88.5
75%	0.58	86.5
50%	0.47	84.5

Notes:
 Downloaded from <http://dealerselectric.com>
 Generated for Model #00212XT3H184T

Performed by

Checked



Dealers Industrial Equipment

No.:

Date: 12-SEP-2016

PERFORMANCE CURVES RELATED TO RATED OUTPUT

Three-phase induction motor - Squirrel cage rotor

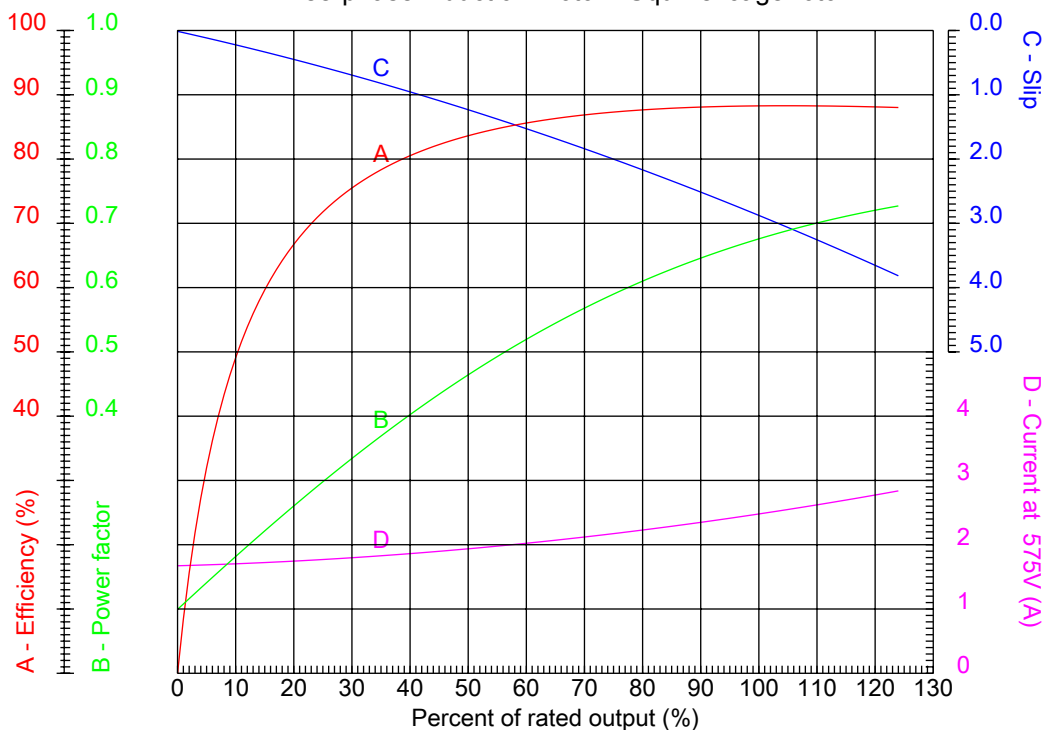

Customer :
 Product line : Three-Phase : Explosion Proof - NEMA Premium

Frame : 184T	Locked rotor current (I _L /I _n) : 7.0
Output : 2 HP	Duty cycle : S1
Frequency : 60 Hz	Service factor : 1.15
Full load speed : 1165 rpm	Design : B
Voltage : 575 V	Locked rotor torque : 260 %
Rated current : 2.50 A	Breakdown torque : 330 %
Insulation class : F	

Notes:
 Downloaded from <http://dealerselectric.com>
 Generated for Model #00212XT3H184T

Performed by

Checked



Dealers Industrial Equipment

No.:

Date: 12-SEP-2016

CHARACTERISTIC CURVES RELATED TO SPEED

Three-phase induction motor - Squirrel cage rotor

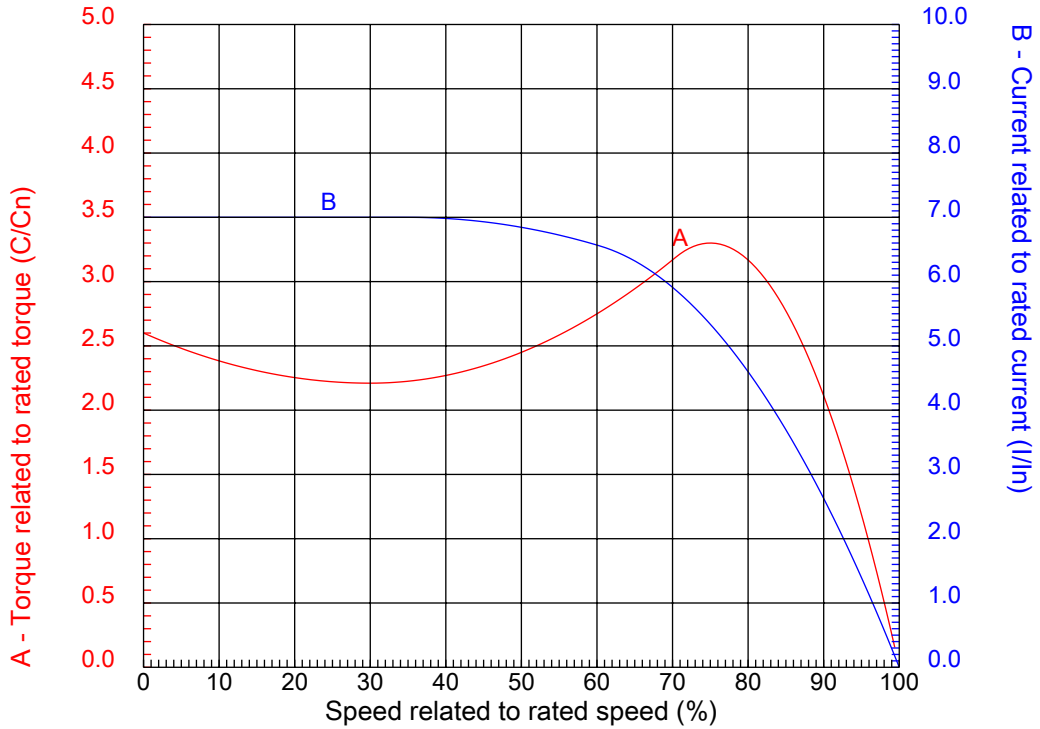

Customer :
Product line : Three-Phase : Explosion Proof - NEMA Premium

Frame	: 184T	Locked rotor current (I _l /I _n)	: 7.0
Output	: 2 HP	Duty cycle	: S1
Frequency	: 60 Hz	Service factor	: 1.15
Full load speed	: 1165 rpm	Design	: B
Voltage	: 575 V	Locked rotor torque	: 260 %
Rated current	: 2.50 A	Breakdown torque	: 330 %
Insulation class	: F		

Notes:
Downloaded from <http://dealerselectric.com>
Generated for Model #00212XT3H184T

Performed by

Checked

1 2 3 4 5 6 7 8

A

B

C

D

E

F

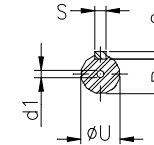
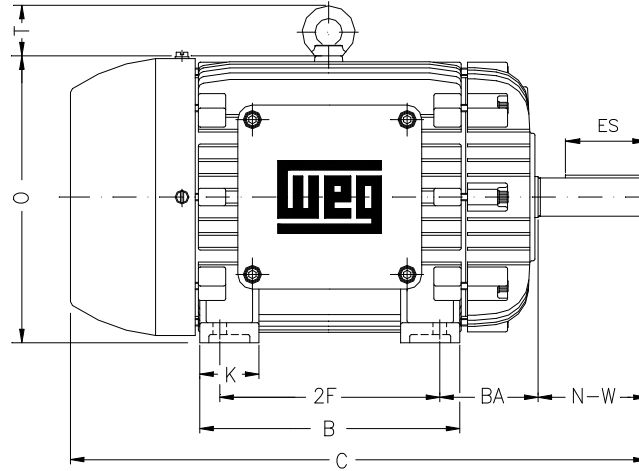
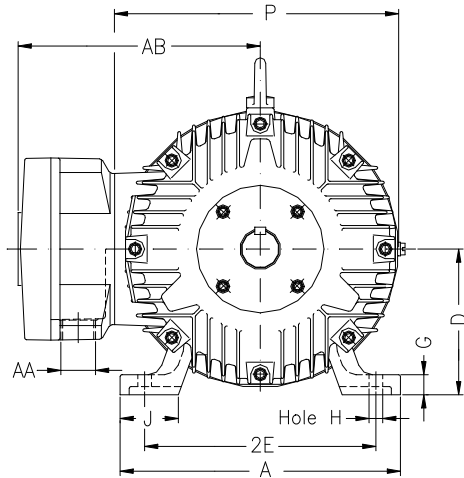

Notes: Downloaded from <http://dealerselectric.com>
Generated for Model #00212XT3H184T

Performed by:

Checked:

Customer:

Three-Phase : Explosion Proof - NEMA Premium

Three-phase induction motor
Frame 184T - IP55

12-SEP-2016



2E 7.500	A 8.661	2F 5.500	B 6.969	BA 2.750
J 1.890	K 1.969	P 8.909	ES 1.969	depth 0.250
S 0.250	N-W 2.750	U 1.125	R 0.984	AB 8.240
D 4.500	G 0.787	O 9.421	T 1.772	H 0.406
C 15.862	AA NPT 3/4"	d1 A 4	d2 A 4	

1 2 3 4 5 6 7 8

A
B
C
D
E
F

RUN



ONLY FOR START



Notes: Downloaded from http://dealerselectric.com Generated for Model #00212XT3H184T		
Performed by:		
Checked:		
Customer:		
Three-Phase : Explosion Proof - NEMA Premium		
Three-phase induction motor Frame 184T - IP55	12-SEP-2016	