



Dealers Industrial Equipment

No.:

Date: 12-SEP-2016

Customer :

TECHNICAL PROPOSAL

Three-phase induction motor - Squirrel cage rotor

Product line : ODP – Open Induction Motors – NEMA Premium Efficiency

Catalog Number : 00156OT3H143T

List Price : \$442

Notes:

Downloaded from <http://dealerselectric.com>

Generated for Model #00156OT3H143T

Performed by:

Checked:



Dealers Industrial Equipment

No.:

Date: 12-SEP-2016

DATA SHEET Three-phase induction motor - Squirrel cage rotor

Customer :
 Product line : ODP – Open Induction Motors – NEMA Premium Efficiency

Frame : E143/5T
 Output : 1.5 HP
 Frequency : 60 Hz
 Poles : 2
 Full load speed : 3430 rpm
 Slip : 4.72 %
 Voltage : 575 V
 Rated current : 1.49 A
 Locked rotor current : 13.4 A
 Locked rotor current (I_L/I_n) : 9.0
 No-load current : 0.624 A
 Full load torque : 2.27 lb.ft
 Locked rotor torque : 400 %
 Breakdown torque : 350 %
 Design : B
 Insulation class : F
 Temperature rise : 80 K
 Locked rotor time : 15 s (hot)
 Service factor : 1.15
 Duty cycle : S1
 Ambient temperature : -20°C - +40°C
 Altitude : 1000 m
 Degree of Protection : IP21
 Approximate weight : 38 lb
 Moment of inertia : 0.05126 sq.ft.lb
 Noise level : ---

	D.E.	N.D.E.
Bearings	6205 ZZ	6204 ZZ
Regreasing interval	---	---
Grease amount	---	---

Load	Power factor	Efficiency (%)
100%	0.87	85.5
75%	0.80	85.5
50%	0.70	82.5

Notes:
 Downloaded from <http://dealerselectric.com>
 Generated for Model #00156OT3H143T

Performed by

Checked



Dealers Industrial Equipment

No.:

Date: 12-SEP-2016

PERFORMANCE CURVES RELATED TO RATED OUTPUT

Three-phase induction motor - Squirrel cage rotor

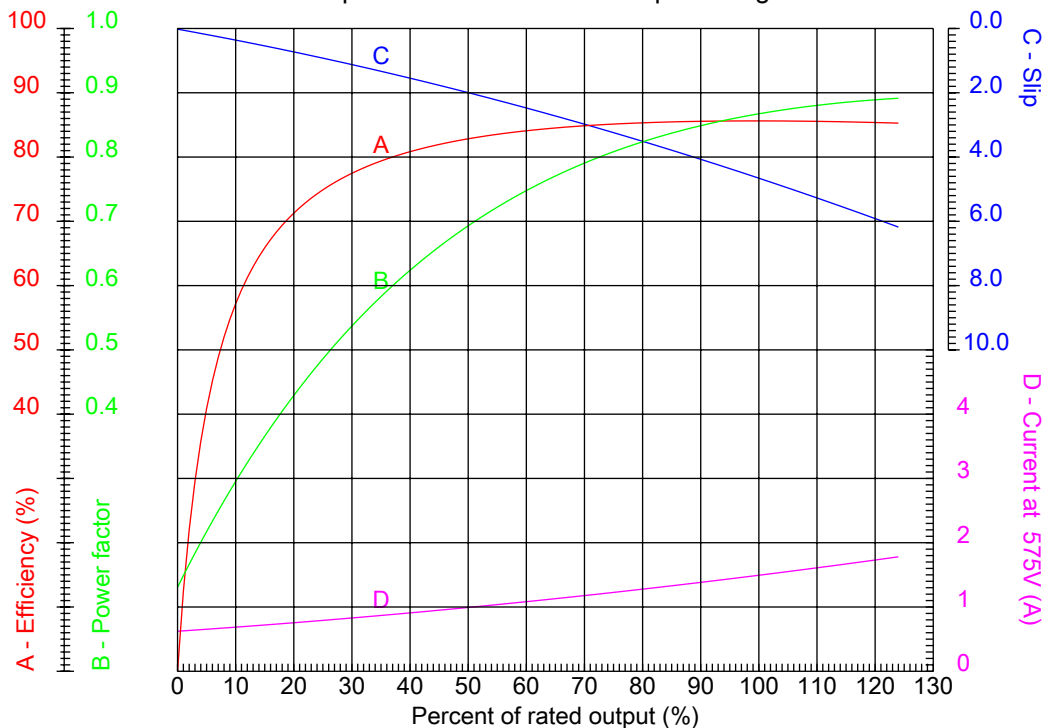

Customer :
Product line : ODP – Open Induction Motors – NEMA Premium Efficiency

Frame	: E143/5T	Locked rotor current (I _l /I _n)	: 9.0
Output	: 1.5 HP	Duty cycle	: S1
Frequency	: 60 Hz	Service factor	: 1.15
Full load speed	: 3430 rpm	Design	: B
Voltage	: 575 V	Locked rotor torque	: 400 %
Rated current	: 1.49 A	Breakdown torque	: 350 %
Insulation class	: F		

Notes:
Downloaded from <http://dealerselectric.com>
Generated for Model #00156OT3H143T

Performed by

Checked



Dealers Industrial Equipment

No.:

Date: 12-SEP-2016

CHARACTERISTIC CURVES RELATED TO SPEED

Three-phase induction motor - Squirrel cage rotor

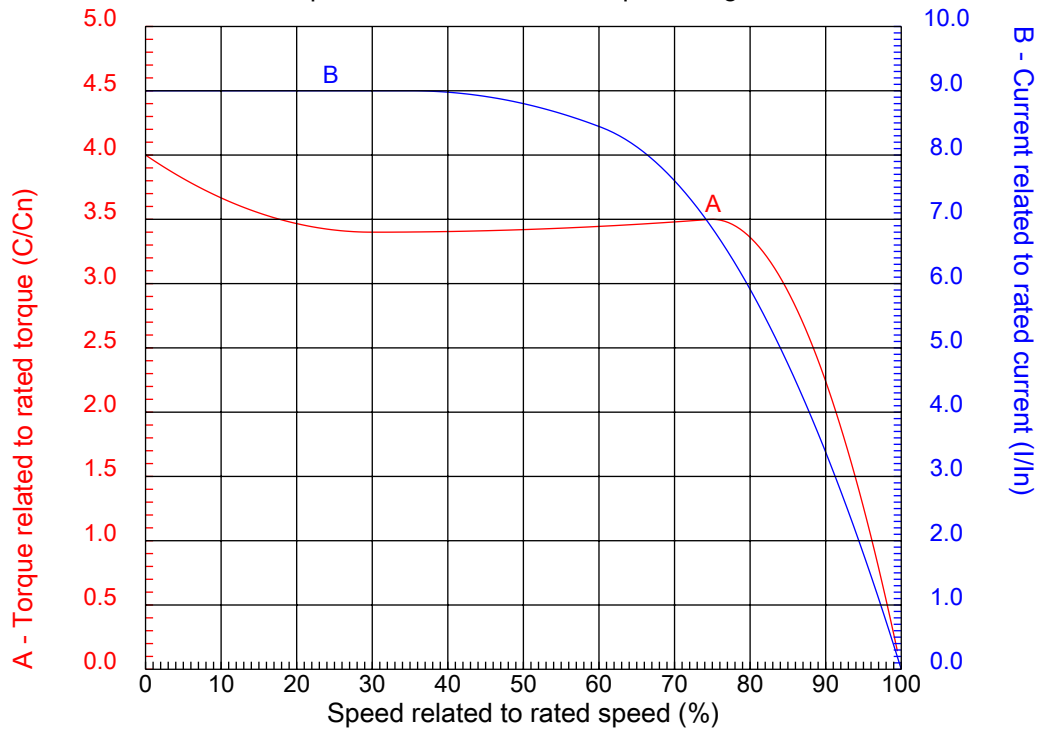

Customer :
 Product line : ODP – Open Induction Motors – NEMA Premium Efficiency

Frame	: E143/5T	Locked rotor current (I _l /I _n)	: 9.0
Output	: 1.5 HP	Duty cycle	: S1
Frequency	: 60 Hz	Service factor	: 1.15
Full load speed	: 3430 rpm	Design	: B
Voltage	: 575 V	Locked rotor torque	: 400 %
Rated current	: 1.49 A	Breakdown torque	: 350 %
Insulation class	: F		

Notes:
 Downloaded from <http://dealerselectric.com>
 Generated for Model #00156OT3H143T

Performed by

Checked

1 2 3 4 5 6 7 8

A

B

C

D

E

F

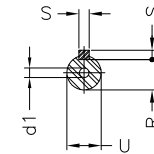
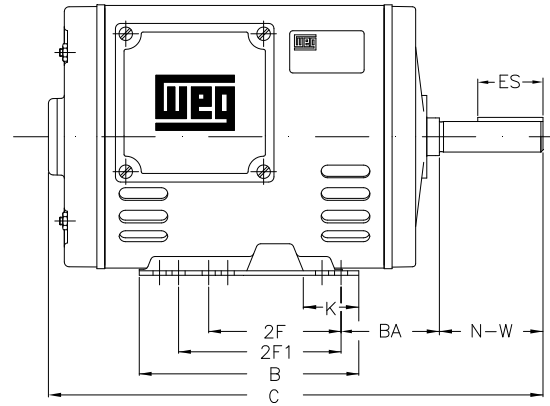
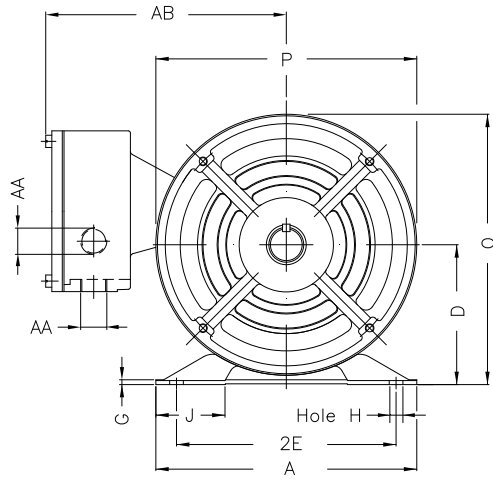

Notes: Downloaded from <http://dealerselectric.com>
Generated for Model #00156OT3H143T

Performed by:

Checked:

Customer:

ODP – Open Induction Motors – NEMA Premium Efficiency

Three-phase induction motor
Frame E143/5T - IP21

12-SEP-2016



2E 5.500	J 1.732	A 6.535	P 6.535	AB 5.433
2F 4.000/5.000	K 1.988	B 6.496	BA 2.250	U 0.8750
d1 A 3,15	N-W 2.250	ES 1.417	S 0.187	R 0.766
depth 0.187	D 3.500	G 0.120	O 6.772	H 0.342
C 12.047	AA 2xNPT 1/2"			

1 2 3 4 5 6 7 8

A

B

C

D

E

F



Notes: Downloaded from <http://dealerselectric.com>
Generated for Model #00156OT3H143T

Performed by:

Checked:

Customer:

ODP – Open Induction Motors – NEMA Premium Efficiency

Three-phase induction motor
Frame E143/5T - IP21

12-SEP-2016

