



Dealers Industrial Equipment

No.:

Date: 12-SEP-2016

Customer :

TECHNICAL PROPOSAL

Three-phase induction motor - Squirrel cage rotor

Product line : Close Coupled Pump: Three-Phase - W22 "JP" Type - TEFC - NEMA Premium

Catalog Number : 00118ET3E143JP-W22

List Price : \$624

Notes:

Downloaded from <http://dealerselectric.com>

Generated for Model #00118ET3E143JP-W22

Performed by:

Checked:



Dealers Industrial Equipment

No.:

Date: 12-SEP-2016

DATA SHEET Three-phase induction motor - Squirrel cage rotor

Customer :
 Product line : Close Coupled Pump: Three-Phase - W22 "JP" Type - TEFC - NEMA Premium

Frame : 143/5JP
 Output : 1 HP
 Frequency : 60 Hz
 Poles : 4
 Full load speed : 1760 rpm
 Slip : 2.22 %
 Voltage : 208-230/460 V
 Rated current : 3.07-2.94/1.47 A
 Locked rotor current : 24.7/12.3 A
 Locked rotor current (I_L/I_n) : 8.4
 No-load current : 1.88/0.940 A
 Full load torque : 2.94 lb.ft
 Locked rotor torque : 320 %
 Breakdown torque : 350 %
 Design : B
 Insulation class : F
 Temperature rise : 80 K
 Locked rotor time : 18 s (hot)
 Service factor : 1.25
 Duty cycle : S1
 Ambient temperature : -20°C - +40°C
 Altitude : 1000 m
 Degree of Protection : IP55
 Approximate weight : 41 lb
 Moment of inertia : 0.11723 sq.ft.lb
 Noise level : 51 dB(A)

	D.E.	N.D.E.
Bearings	6206 ZZ	6204 ZZ
Regreasing interval	---	---
Grease amount	---	---

Load	Power factor	Efficiency (%)
100%	0.75	85.5
75%	0.68	84.0
50%	0.55	80.0

Notes:
 Downloaded from <http://dealerselectric.com>
 Generated for Model #00118ET3E143JP-W22

Performed by

Checked



Dealers Industrial Equipment

No.:

Date: 12-SEP-2016

PERFORMANCE CURVES RELATED TO RATED OUTPUT

Three-phase induction motor - Squirrel cage rotor

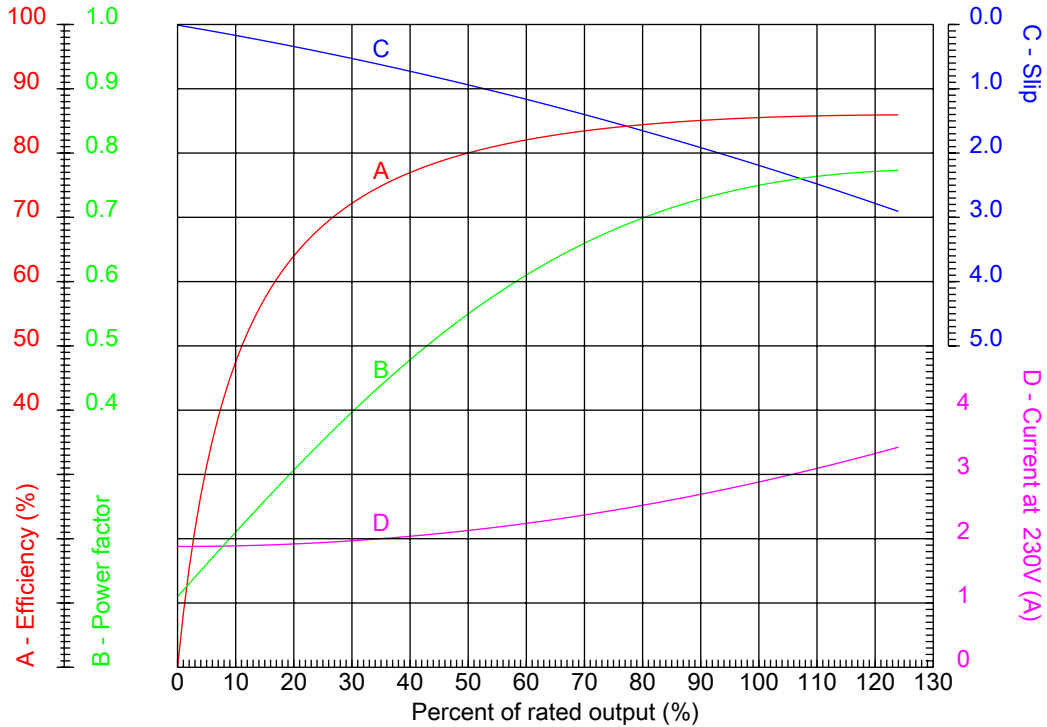

Customer :
 Product line : Close Coupled Pump: Three-Phase - W22 "JP" Type - TEFC - NEMA Premium

Frame	: 143/5JP	Locked rotor current (I _l /I _n)	: 8.4
Output	: 1 HP	Duty cycle	: S1
Frequency	: 60 Hz	Service factor	: 1.25
Full load speed	: 1760 rpm	Design	: B
Voltage	: 208-230/460 V	Locked rotor torque	: 320 %
Rated current	: 3.07-2.94/1.47 A	Breakdown torque	: 350 %
Insulation class	: F		

Notes:
 Downloaded from <http://dealerselectric.com>
 Generated for Model #00118ET3E143JP-W22

Performed by

Checked



Dealers Industrial Equipment

No.:

Date: 12-SEP-2016

CHARACTERISTIC CURVES RELATED TO SPEED

Three-phase induction motor - Squirrel cage rotor

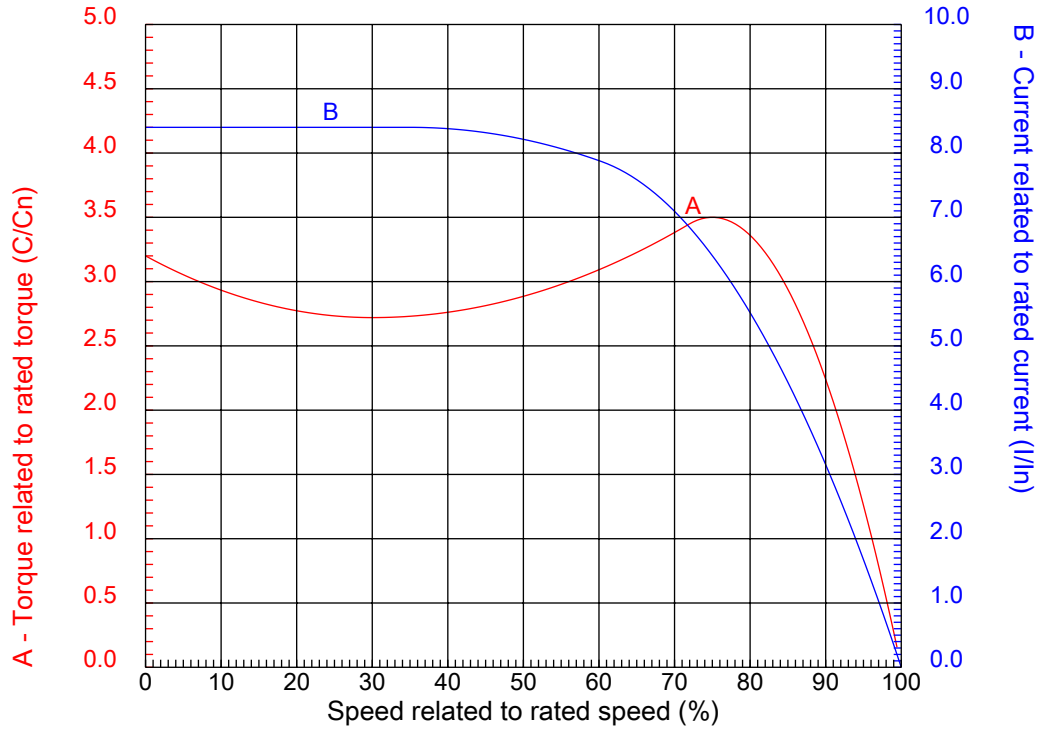

Customer :
Product line : Close Coupled Pump: Three-Phase - W22 "JP" Type - TEFC - NEMA Premium

Frame	: 143/5JP	Locked rotor current (I _l /I _n)	: 8.4
Output	: 1 HP	Duty cycle	: S1
Frequency	: 60 Hz	Service factor	: 1.25
Full load speed	: 1760 rpm	Design	: B
Voltage	: 208-230/460 V	Locked rotor torque	: 320 %
Rated current	: 3.07-2.94/1.47 A	Breakdown torque	: 350 %
Insulation class	: F		

Notes:
Downloaded from <http://dealerselectric.com>
Generated for Model #00118ET3E143JP-W22

Performed by

Checked

1 2 3 4 5 6 7 8

A

B

C

D

E

F

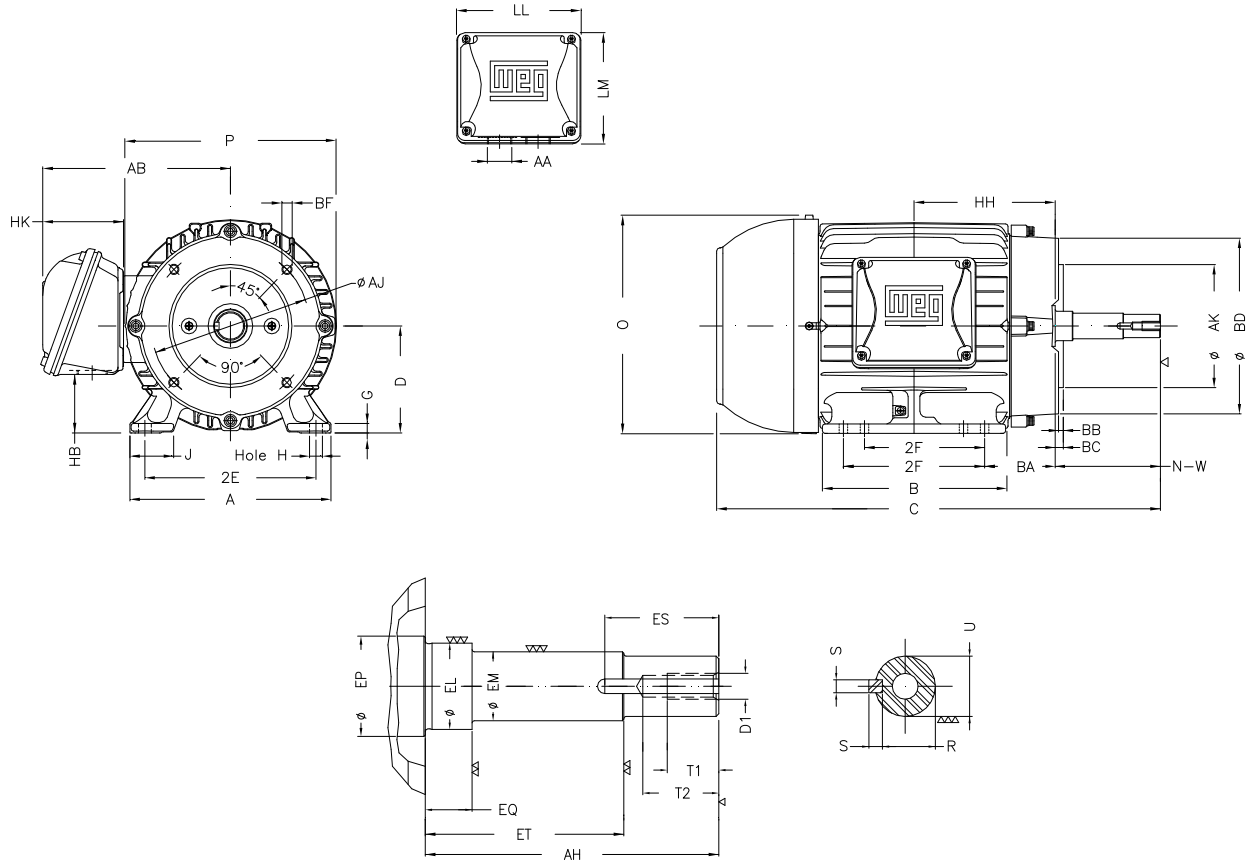

Notes: Downloaded from <http://dealerselectric.com>
Generated for Model #00118ET3E143JP-W22

Performed by:

Checked:

Customer:

Close Coupled Pump: Three-Phase - W22 "JP" Type - TEFC - NEMA Premium

Three-phase induction motor
Frame 143/5JP - IP55

12-SEP-2016



2E 5.500	J 1.437	A 6.457	P 7.047	AB 6.260
2F 4.000/5.000	B 6.142	BA 2.560	D 3.500	G 0.354
O 7.122	H 0.344	AA NPT 3/4"	EQ 1.563	ET 5.941
U 0.874	EM 1.000	EL 1.156	EP 1.179	ES 1.654
t1 0.748	t2 1.102	C 18.736	d1 EUNC 3/8"-16	HH 4.750
HK 2.638	HB 1.787	LL 4.528	LM 4.094	S 0.187
R 0.768	Flange FC-149	AJ 5.874	AK 4.500	BD 6.496
BF UNC 3/8"x16	BB 0.157	AH 7.319		

1 2 3 4 5 6 7 8

A

LOW VOLTAGE

HIGH VOLTAGE

B



C



D

E

F

Notes: Downloaded from <http://dealerselectric.com>
 Generated for Model #00118ET3E143JP-W22

Performed by:

Checked:

Customer:

Close Coupled Pump: Three-Phase - W22 "JP" Type - TEFC - NEMA Premium

Three-phase induction motor
 Frame 143/5JP - IP55

12-SEP-2016

