



# Dealers Industrial Equipment

No.:

Date: 12-SEP-2016

Customer :

## TECHNICAL PROPOSAL

### Three-phase induction motor - Squirrel cage rotor

Product line : Three Phase: W01 (Rolled Steel) - TEFC - High Efficiency

Catalog Number : 00118EP3ER143TC-S

List Price : \$>(discontinued)</span>

#### Notes:

Downloaded from <http://dealerselectric.com>

Generated for Model #00118EP3ER143TC-S

Performed by:

Checked:



# Dealers Industrial Equipment

No.:

Date: 12-SEP-2016

## DATA SHEET Three-phase induction motor - Squirrel cage rotor

Customer :  
 Product line : Three Phase: W01 (Rolled Steel) - TEFC - High Efficiency

Frame : 143/5T  
 Output : 1 HP  
 Frequency : 60 Hz  
 Poles : 4  
 Full load speed : 1760 rpm  
 Slip : 2.22 %  
 Voltage : 208-230/460 V  
 Rated current : 3.45-3.12/1.56 A  
 Locked rotor current : 23.7/11.9 A  
 Locked rotor current (I<sub>L</sub>/I<sub>n</sub>) : 7.6  
 No-load current : 2.07/1.04 A  
 Full load torque : 2.94 lb.ft  
 Locked rotor torque : 290 %  
 Breakdown torque : 350 %  
 Design : B  
 Insulation class : F  
 Temperature rise : 80 K  
 Locked rotor time : 18 s (hot)  
 Service factor : 1.15  
 Duty cycle : S1  
 Ambient temperature : -20°C - +40°C  
 Altitude : 1000 m  
 Degree of Protection : IP55  
 Approximate weight : 32 lb  
 Moment of inertia : 0.09729 sq.ft.lb  
 Noise level : 52 dB(A)

	D.E.	N.D.E.
Bearings	6205 ZZ	6203 ZZ
Regreasing interval	---	---
Grease amount	---	---

Load	Power factor	Efficiency (%)
100%	0.73	82.5
75%	0.64	82.5
50%	0.50	78.5

Notes:  
 Downloaded from <http://dealerselectric.com>  
 Generated for Model #00118EP3ER143TC-S

Performed by

Checked



# Dealers Industrial Equipment

No.:

Date: 12-SEP-2016

## PERFORMANCE CURVES RELATED TO RATED OUTPUT

Three-phase induction motor - Squirrel cage rotor

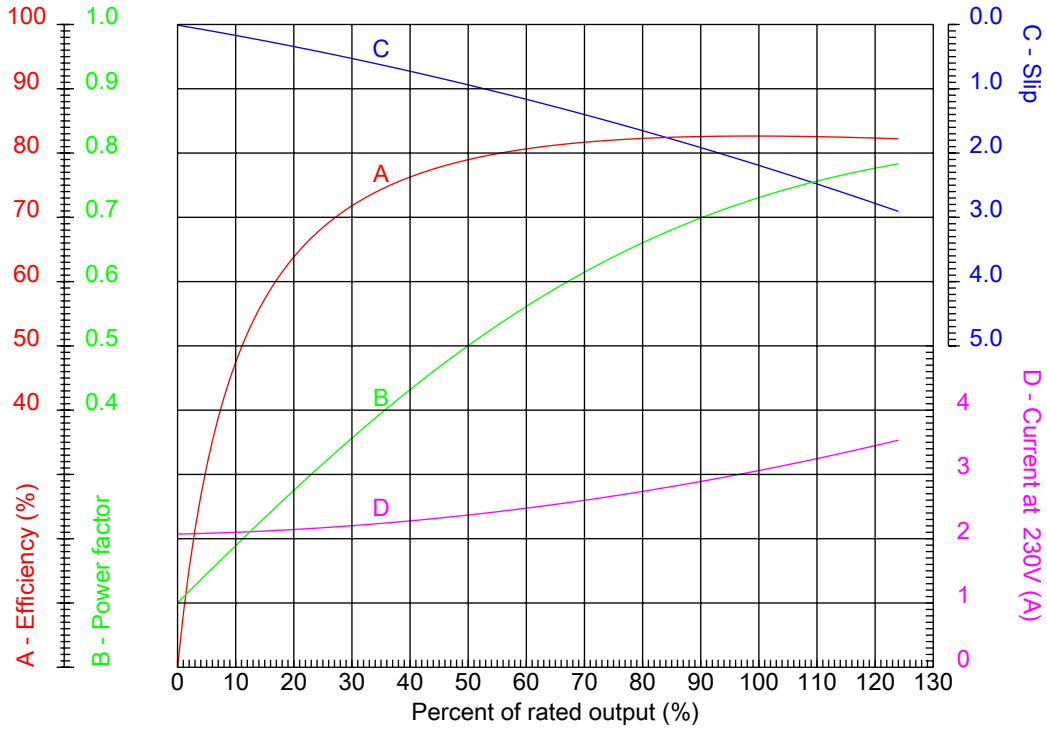

Customer :  
Product line : Three Phase: W01 (Rolled Steel) - TEFC - High Efficiency

Frame	: 143/5T	Locked rotor current (I <sub>l</sub> /I <sub>n</sub> )	: 7.6
Output	: 1 HP	Duty cycle	: S1
Frequency	: 60 Hz	Service factor	: 1.15
Full load speed	: 1760 rpm	Design	: B
Voltage	: 208-230/460 V	Locked rotor torque	: 290 %
Rated current	: 3.45-3.12/1.56 A	Breakdown torque	: 350 %
Insulation class	: F		

Notes:  
Downloaded from <http://dealerselectric.com>  
Generated for Model #00118EP3ER143TC-S

Performed by

Checked



# Dealers Industrial Equipment

No.:

Date: 12-SEP-2016

## CHARACTERISTIC CURVES RELATED TO SPEED

Three-phase induction motor - Squirrel cage rotor

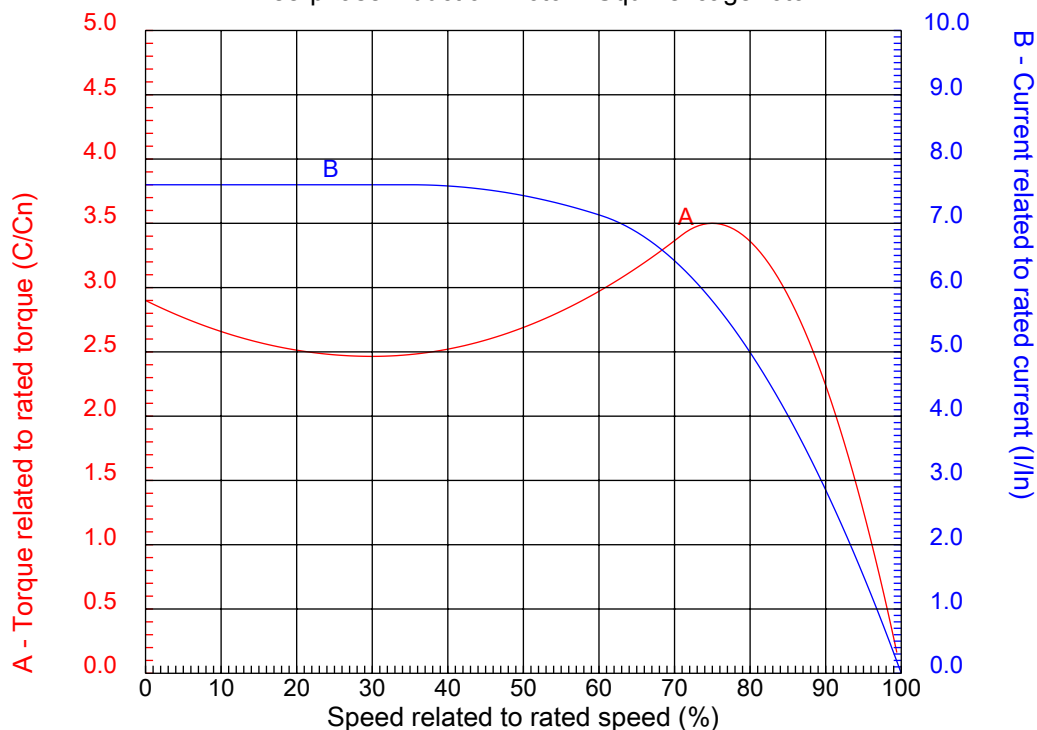

Customer :  
Product line : Three Phase: W01 (Rolled Steel) - TEFC - High Efficiency

Frame	: 143/5T	Locked rotor current (I <sub>l</sub> /I <sub>n</sub> )	: 7.6
Output	: 1 HP	Duty cycle	: S1
Frequency	: 60 Hz	Service factor	: 1.15
Full load speed	: 1760 rpm	Design	: B
Voltage	: 208-230/460 V	Locked rotor torque	: 290 %
Rated current	: 3.45-3.12/1.56 A	Breakdown torque	: 350 %
Insulation class	: F		

Notes:  
Downloaded from <http://dealerselectric.com>  
Generated for Model #00118EP3ER143TC-S

Performed by

Checked

1 2 3 4 5 6 7 8

A

B

C

D

E

F

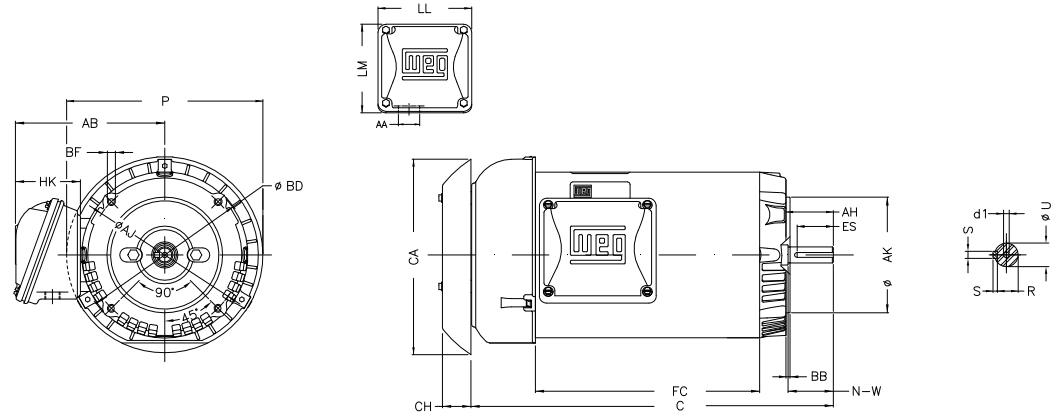

Notes: Downloaded from <http://dealerselectric.com>  
Generated for Model #00118EP3ER143TC-S

Performed by:

Checked:

Customer:

Three Phase: W01 (Rolled Steel) - TEFC - High Efficiency

Three-phase induction motor  
Frame 143/5T - IP55

12-SEP-2016



P	AB	HK	FC	C
7.638	5.882	2.638	7.480	13.189
N-W	ES	d1	S	U
2.250	1.417	A 3.15	0.187	0.875
AA	depth	R	LL	LM
1.118"	0.187	0.771	4.543	4.106
CH	Flange	AJ	AK	BD
1.377	FC-149	5.874	4.500	6.450
BF	BB	AH		
UNC 3/8"x16	0.157	2.132		

1 2 3 4 5 6 7 8

A

### LOW VOLTAGE

### HIGH VOLTAGE

B

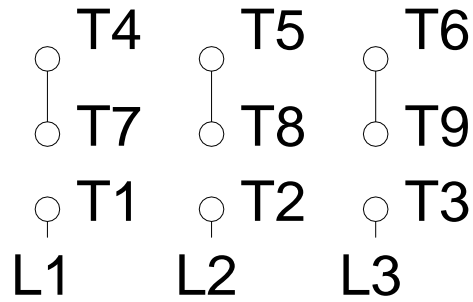
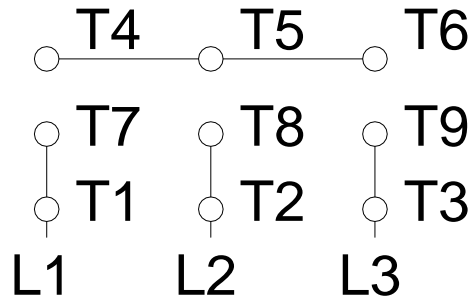

C



D

E

F

Notes: Downloaded from <http://dealerselectric.com>  
 Generated for Model #00118EP3ER143TC-S

Performed by:

Checked:

Customer:

Three Phase: W01 (Rolled Steel) - TEFC - High Efficiency

Three-phase induction motor  
 Frame 143/5T - IP55

12-SEP-2016

