



Dealers Industrial Equipment

No.:

Date: 12-SEP-2016

Customer :

TECHNICAL PROPOSAL

Three-phase induction motor - Squirrel cage rotor

Product line : Three Phase: W01 (Rolled Steel) - TEFC - NEMA Premium Efficiency

Catalog Number : 00112ET3H145T-S

List Price : \$529

Notes:

Downloaded from <http://dealerselectric.com>

Generated for Model #00112ET3H145T-S

Performed by:

Checked:



Dealers Industrial Equipment

No.:

Date: 12-SEP-2016

DATA SHEET Three-phase induction motor - Squirrel cage rotor

Customer :
 Product line : Three Phase: W01 (Rolled Steel) - TEFC - NEMA Premium Efficiency

Frame : 143/5T
 Output : 1 HP
 Frequency : 60 Hz
 Poles : 6
 Full load speed : 1145 rpm
 Slip : 4.58 %
 Voltage : 575 V
 Rated current : 1.26 A
 Locked rotor current : 7.33 A
 Locked rotor current (I_L/I_n) : 5.8
 No-load current : 0.810 A
 Full load torque : 4.52 lb.ft
 Locked rotor torque : 230 %
 Breakdown torque : 280 %
 Design : B
 Insulation class : F
 Temperature rise : 80 K
 Locked rotor time : 31 s (hot)
 Service factor : 1.15
 Duty cycle : S1
 Ambient temperature : -20°C - +40°C
 Altitude : 1000 m
 Degree of Protection : IP55
 Approximate weight : 39 lb
 Moment of inertia : 0.15970 sq.ft.lb
 Noise level : 49 dB(A)

	D.E.	N.D.E.
Bearings	6205 ZZ	6203 ZZ
Regreasing interval	---	---
Grease amount	---	---

Load	Power factor	Efficiency (%)
100%	0.72	82.5
75%	0.63	82.5
50%	0.50	80.0

Notes:
 Downloaded from <http://dealerselectric.com>
 Generated for Model #00112ET3H145T-S

Performed by

Checked



Dealers Industrial Equipment

No.:

Date: 12-SEP-2016

PERFORMANCE CURVES RELATED TO RATED OUTPUT

Three-phase induction motor - Squirrel cage rotor

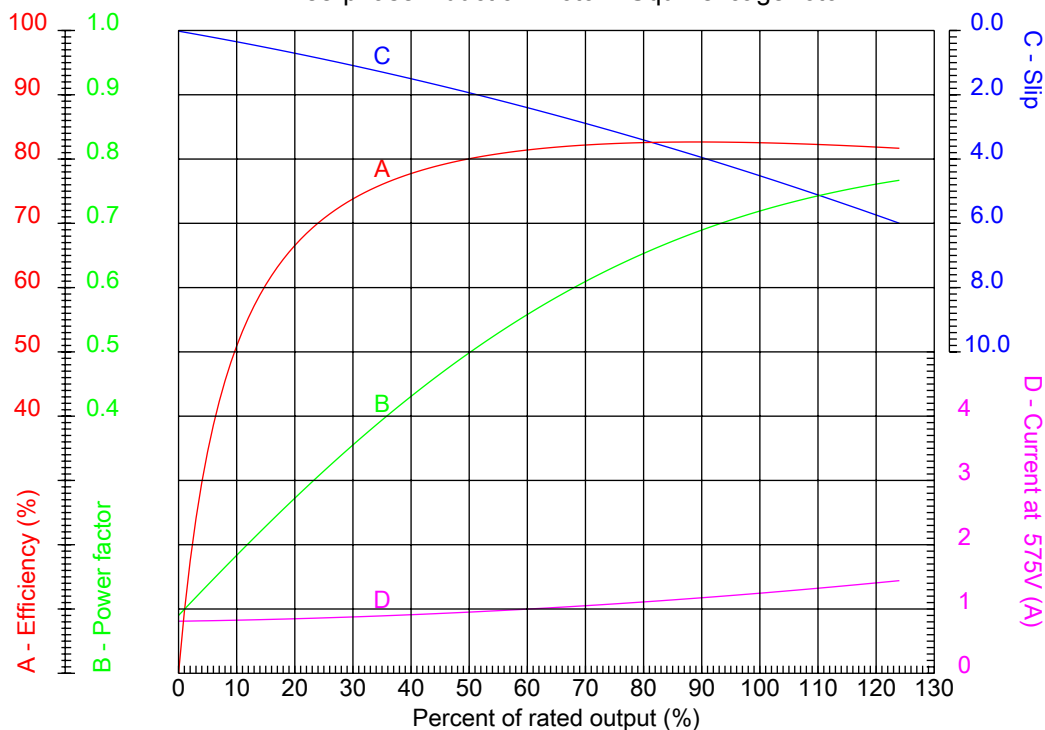

Customer :
Product line : Three Phase: W01 (Rolled Steel) - TEFC - NEMA Premium Efficiency

Frame	: 143/5T	Locked rotor current (I _l /I _n)	: 5.8
Output	: 1 HP	Duty cycle	: S1
Frequency	: 60 Hz	Service factor	: 1.15
Full load speed	: 1145 rpm	Design	: B
Voltage	: 575 V	Locked rotor torque	: 230 %
Rated current	: 1.26 A	Breakdown torque	: 280 %
Insulation class	: F		

Notes:
Downloaded from <http://dealerselectric.com>
Generated for Model #00112ET3H145T-S

Performed by

Checked



Dealers Industrial Equipment

No.:

Date: 12-SEP-2016

CHARACTERISTIC CURVES RELATED TO SPEED

Three-phase induction motor - Squirrel cage rotor

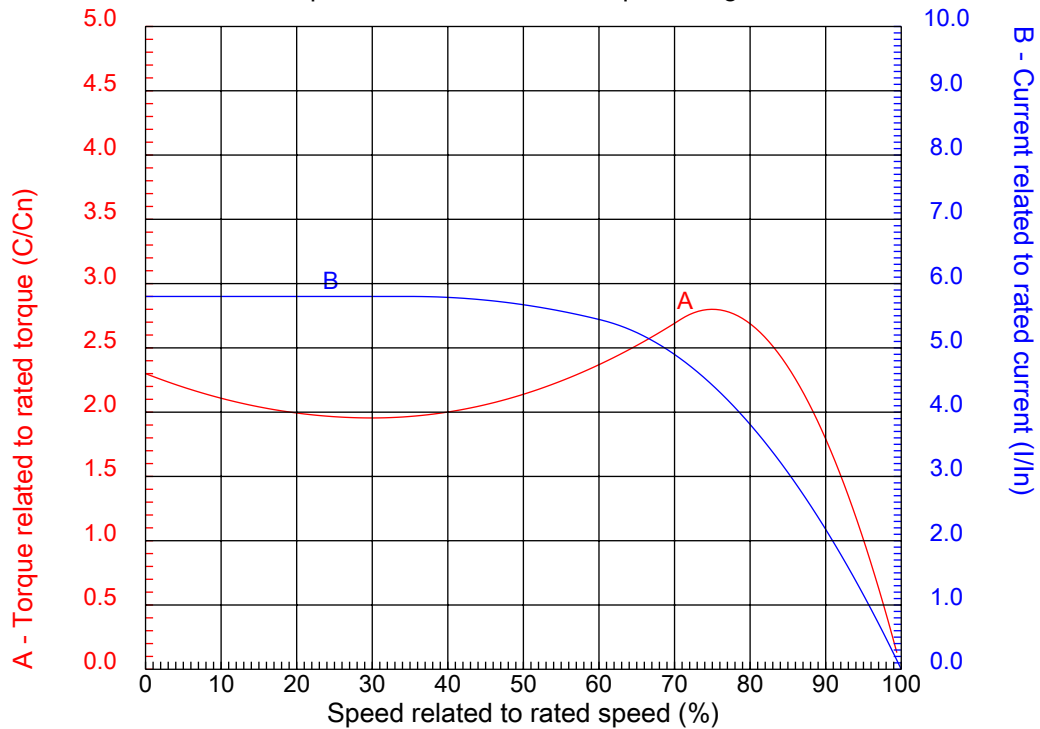

Customer :
Product line : Three Phase: W01 (Rolled Steel) - TEFC - NEMA Premium Efficiency

Frame	: 143/5T	Locked rotor current (I _l /I _n)	: 5.8
Output	: 1 HP	Duty cycle	: S1
Frequency	: 60 Hz	Service factor	: 1.15
Full load speed	: 1145 rpm	Design	: B
Voltage	: 575 V	Locked rotor torque	: 230 %
Rated current	: 1.26 A	Breakdown torque	: 280 %
Insulation class	: F		

Notes:
Downloaded from <http://dealerselectric.com>
Generated for Model #00112ET3H145T-S

Performed by

Checked

1 2 3 4 5 6 7 8

A
B
C
D
E
F

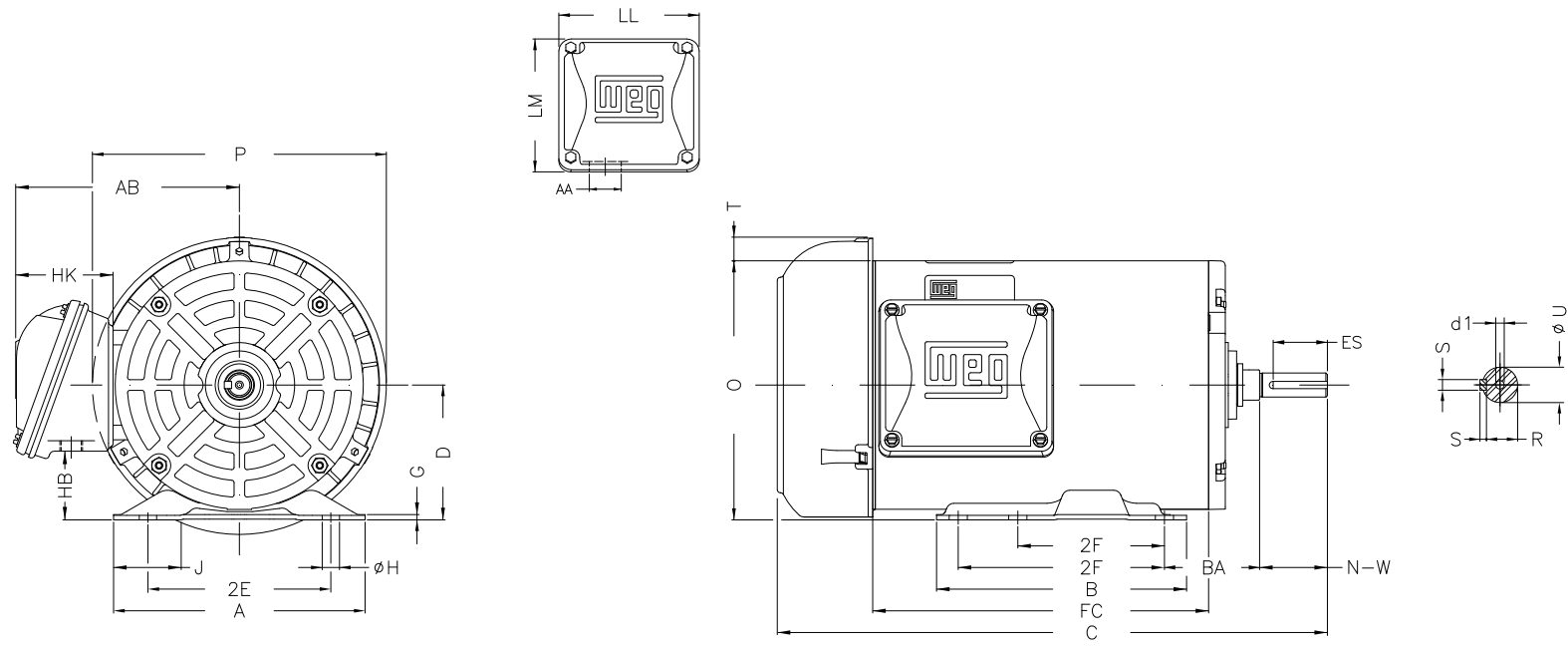

Notes: Downloaded from <http://dealerselectric.com>
Generated for Model #00112ET3H145T-S

Performed by:

Checked:

Customer:

Three Phase: W01 (Rolled Steel) - TEFC - NEMA Premium Efficiency

P	AB	J	2E	A
7.638	5.882	1.732	5.500	6.535
H	G	HB	HK	T
0.343	0.120	1.783	2.638	0.603
O	FC	2F	B	C
6.724	7.874	4.000/5.000	6.496	13.583
BA	N-W	ES	d1	S
2.250	2.250	1.417	A 3.15	0.187
U	AA	depth	R	LL
0.875	1.118"	0.187	0.771	4.543
LM	BB	D	CH	
4.106	0.603	3.500	1.377	

Three-phase induction motor
Frame 143/5T - IP55

12-SEP-2016



1 2 3 4 5 6 7 8

A
B
C
D
E
F

RUN



ONLY FOR START



Notes: Downloaded from http://dealerselectric.com Generated for Model #00112ET3H145T-S		
Performed by:		
Checked:		
Customer:		
Three Phase: W01 (Rolled Steel) - TEFC - NEMA Premium Efficiency		
Three-phase induction motor Frame 143/5T - IP55	12-SEP-2016	