



Dealers Industrial Equipment

No.:

Date: 12-SEP-2016

Customer :

TECHNICAL PROPOSAL

Single-phase induction motor - Squirrel cage rotor

Product line : Single-Phase: Fractional Explosion Proof Motors

Catalog Number : .7518XS1B56

List Price : \$868

Notes:

Downloaded from <http://dealerselectric.com>

Generated for Model #.7518XS1B56

Performed by:

Checked:



Dealers Industrial Equipment

No.:

Date: 12-SEP-2016

DATA SHEET

Single-phase induction motor - Squirrel cage rotor

Customer :
Product line : Single-Phase: Fractional Explosion Proof Motors

Frame : 56
Output : 0.75 HP
Frequency : 60 Hz
Poles : 4
Full load speed : 1725 rpm
Slip : 4.17 %
Voltage : 115/208-230 V
Rated current : 10.4/5.20 A
Locked rotor current : 52.0/26.0 A
Locked rotor current (I_L/I_n) : 5.0
No-load current : 7.20/3.60 A
Full load torque : 2.25 lb.ft
Locked rotor torque : 330 %
Breakdown torque : 260 %
Design : ---
Insulation class : F
Temperature rise : 80 K
Locked rotor time : 11 s (hot)
Service factor : 1.00
Duty cycle : S1
Ambient temperature : -20°C - +50°C
Altitude : 1000 m
Degree of Protection : IP55
Approximate weight : 31 lb
Moment of inertia : 0.02681 sq.ft.lb
Noise level : ---

	D.E.	N.D.E.	Load	Power factor	Efficiency (%)
Bearings	6203 ZZ	6203 ZZ	100%	0.70	69.8
Regreasing interval	---	---	75%	0.62	67.0
Grease amount	---	---	50%	0.51	60.0

Notes:

Downloaded from <http://dealerselectric.com>
Generated for Model #.7518XS1B56

Performed by

Checked



Dealers Industrial Equipment

No.:

Date: 12-SEP-2016

PERFORMANCE CURVES RELATED TO RATED OUTPUT

Single-phase induction motor - Squirrel cage rotor

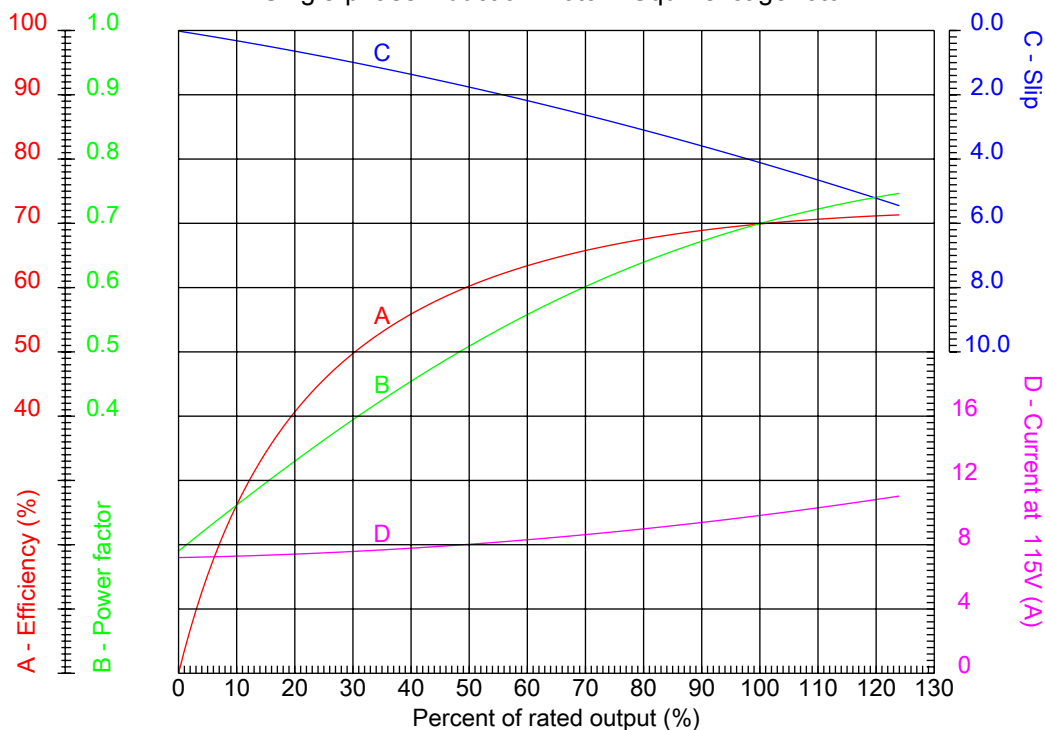

Customer :
 Product line : Single-Phase: Fractional Explosion Proof Motors

Frame	: 56	Locked rotor current (I _l /I _n)	: 5.0
Output	: 0.75 HP	Duty cycle	: S1
Frequency	: 60 Hz	Service factor	: 1.00
Full load speed	: 1725 rpm	Design	: ---
Voltage	: 115/208-230 V	Locked rotor torque	: 330 %
Rated current	: 10.4/5.20 A	Breakdown torque	: 260 %
Insulation class	: F		

Notes:
 Downloaded from <http://dealerselectric.com>
 Generated for Model #.7518XS1B56

Performed by

Checked

1 2 3 4 5 6 7 8

A

B

C

D

E

F

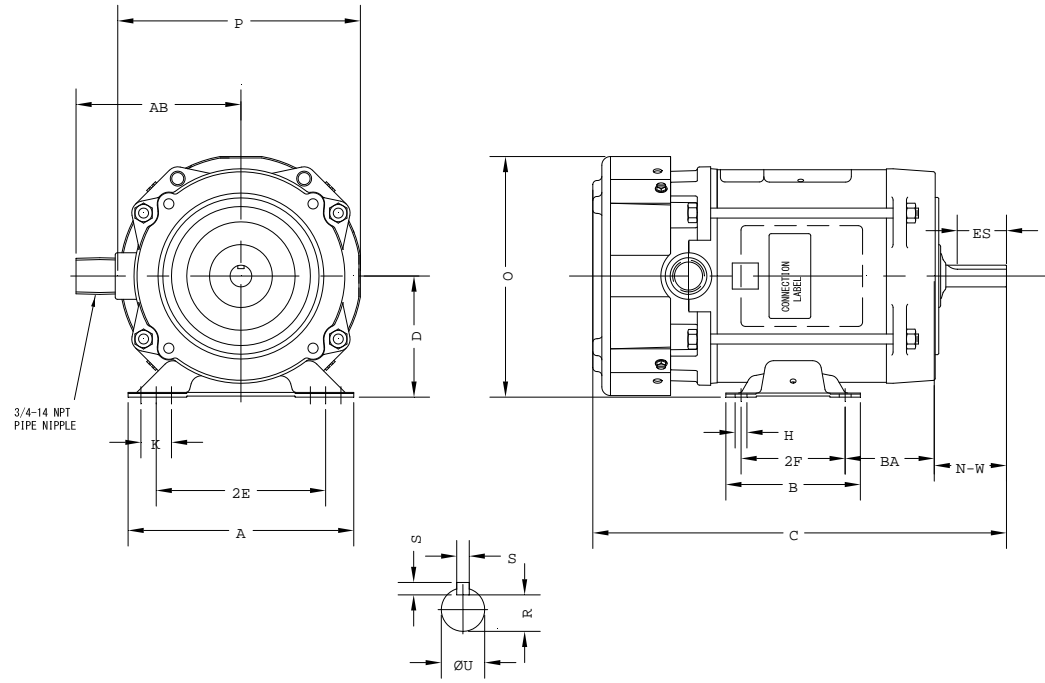

Notes: Downloaded from <http://dealerselectric.com>
Generated for Model #.7518XS1B56

Performed by:

Checked:

Customer:

Single-Phase: Fractional Explosion Proof Motors

2E 4.880	A 6.500	P 6.980	AB 4.500	B 3.880
BA 2.750	U 0.6250	N-W 1.880	ES 1.380	S 0.190
R 0.517	D 3.500	O 6.920	H 0.340	C 13.040
d1 SEM				

Single-phase induction motor
Frame 56 - IP55

12-SEP-2016

