



Dealers Industrial Equipment

No.:

Date: 12-SEP-2016

Customer :

TECHNICAL PROPOSAL

Three-phase induction motor - Squirrel cage rotor

Product line : Three Phase: W01 (Rolled Steel) - TEFC - Standard Efficiency

Catalog Number : .7518ES3E56C-S

List Price : \$332

Notes:

Downloaded from <http://dealerselectric.com>

Generated for Model #.7518ES3E56C-S

Performed by:

Checked:



Dealers Industrial Equipment

No.:

Date: 12-SEP-2016

DATA SHEET Three-phase induction motor - Squirrel cage rotor

Customer :
 Product line : Three Phase: W01 (Rolled Steel) - TEFC - Standard Efficiency

Frame : 56
 Output : 0.75 HP
 Frequency : 60 Hz
 Poles : 4
 Full load speed : 1755 rpm
 Slip : 2.50 %
 Voltage : 208-230/460 V
 Rated current : 2.70-2.44/1.22 A
 Locked rotor current : 16.8/8.42 A
 Locked rotor current (I_L/I_n) : 6.9
 No-load current : 1.80/0.900 A
 Full load torque : 2.21 lb.ft
 Locked rotor torque : 240 %
 Breakdown torque : 300 %
 Design : A
 Insulation class : F
 Temperature rise : 80 K
 Locked rotor time : 17 s (hot)
 Service factor : 1.15
 Duty cycle : S1
 Ambient temperature : -20°C - +40°C
 Altitude : 1000 m
 Degree of Protection : IP55
 Approximate weight : 22 lb
 Moment of inertia : 0.06478 sq.ft.lb
 Noise level : 52 dB(A)

	D.E.	N.D.E.
Bearings	6203 ZZ	6202 ZZ
Regreasing interval	---	---
Grease amount	---	---

Load	Power factor	Efficiency (%)
100%	0.72	78.5
75%	0.61	77.0
50%	0.48	72.0

Notes:
 Downloaded from <http://dealerselectric.com>
 Generated for Model #.7518ES3E56C-S

Performed by

Checked



Dealers Industrial Equipment

No.:

Date: 12-SEP-2016

PERFORMANCE CURVES RELATED TO RATED OUTPUT

Three-phase induction motor - Squirrel cage rotor

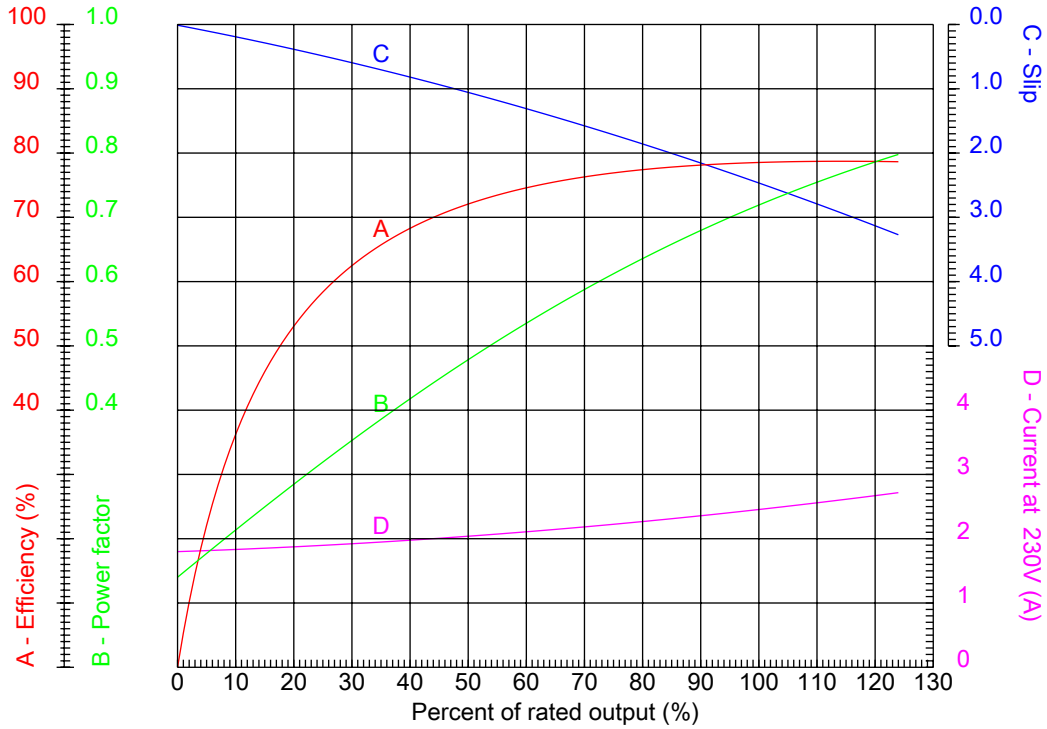

Customer :
 Product line : Three Phase: W01 (Rolled Steel) - TEFC - Standard Efficiency

Frame	: 56	Locked rotor current (I _l /I _n)	: 6.9
Output	: 0.75 HP	Duty cycle	: S1
Frequency	: 60 Hz	Service factor	: 1.15
Full load speed	: 1755 rpm	Design	: A
Voltage	: 208-230/460 V	Locked rotor torque	: 240 %
Rated current	: 2.70-2.44/1.22 A	Breakdown torque	: 300 %
Insulation class	: F		

Notes:
 Downloaded from <http://dealerselectric.com>
 Generated for Model #.7518ES3E56C-S

Performed by

Checked



Dealers Industrial Equipment

No.:

Date: 12-SEP-2016

CHARACTERISTIC CURVES RELATED TO SPEED

Three-phase induction motor - Squirrel cage rotor

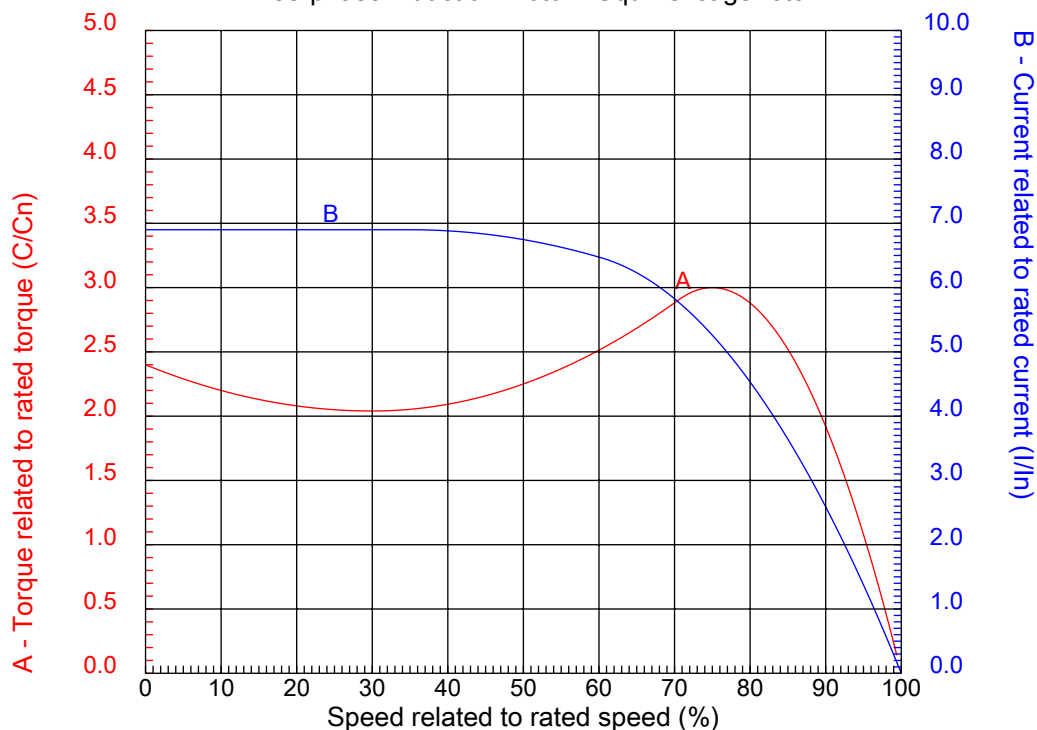

Customer :
Product line : Three Phase: W01 (Rolled Steel) - TEFC - Standard Efficiency

Frame	: 56	Locked rotor current (I _l /I _n)	: 6.9
Output	: 0.75 HP	Duty cycle	: S1
Frequency	: 60 Hz	Service factor	: 1.15
Full load speed	: 1755 rpm	Design	: A
Voltage	: 208-230/460 V	Locked rotor torque	: 240 %
Rated current	: 2.70-2.44/1.22 A	Breakdown torque	: 300 %
Insulation class	: F		

Notes:
Downloaded from <http://dealerselectric.com>
Generated for Model #.7518ES3E56C-S

Performed by

Checked

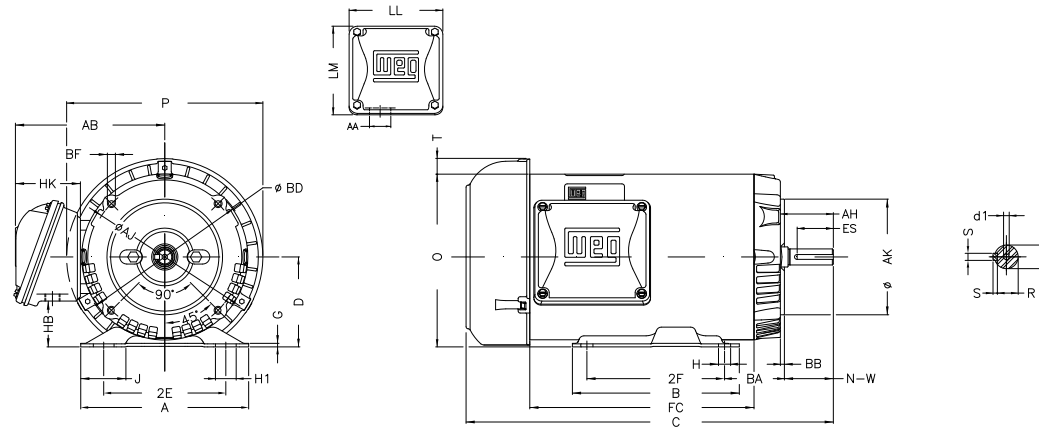

Notes: Downloaded from <http://dealerselectric.com>
Generated for Model #.7518ES3E56C-S

P	AB	J	2E	A
7.638	5.882	1.732	4.874	6.535
H	G	HB	HK	T
0.343	0.120	1.783	2.638	0.603
O	FC	2F	B	C
6.724	6.299	3.000	4.016	11.929
BA	N-W	ES	d1	S
2.750	1.874	1.417	A 3.15	0.187
U	AA	depth	R	LL
0.625	0.881"	0.187	0.517	4.543
LM	D	Flange	AJ	AK
4.106	3.500	FC-149	5.874	4.500
BD	BF	BB	AH	
6.450	UNC 3/8"x16-2B	0.157	2.062	

Performed by:

Checked:

Customer:

Three Phase: W01 (Rolled Steel) - TEFC - Standard Efficiency

Three-phase induction motor
Frame 56 - IP55

12-SEP-2016

