



Dealers Industrial Equipment

No.:

Date: 12-SEP-2016

Customer :

TECHNICAL PROPOSAL

Single-phase induction motor - Squirrel cage rotor

Product line : Single-Phase : NEMA 56 TEFC

Catalog Number : .7518ES1BB56C

List Price : \$370

Notes:

Downloaded from <http://dealerselectric.com>

Generated for Model #.7518ES1BB56C

Performed by:

Checked:



Dealers Industrial Equipment

No.:

Date: 12-SEP-2016

DATA SHEET Single-phase induction motor - Squirrel cage rotor

Customer :
Product line : Single-Phase : NEMA 56 TEFC

Frame : B56
Output : 0.75 HP
Frequency : 60 Hz
Poles : 4
Full load speed : 1745 rpm
Slip : 3.06 %
Voltage : 115/208-230 V
Rated current : 10.6/5.20-5.30 A
Locked rotor current : 65.7/32.9 A
Locked rotor current (I_L/I_n) : 6.2
No-load current : 8.00/4.00 A
Full load torque : 2.23 lb.ft
Locked rotor torque : 300 %
Breakdown torque : 250 %
Design : ---
Insulation class : B
Temperature rise : 80 K
Locked rotor time : 6 s (hot)
Service factor : 1.15 (1.00 at 208V)
Duty cycle : S1
Ambient temperature : -20°C - +40°C
Altitude : 1000 m
Degree of Protection : IP55
Approximate weight : 28 lb
Moment of inertia : 0.09824 sq.ft.lb
Noise level : ---

	D.E.	N.D.E.
Bearings	6203 ZZ	6202 ZZ
Regreasing interval	---	---
Grease amount	---	---

Load	Power factor	Efficiency (%)
100%	0.66	68.5
75%	0.58	66.0
50%	0.47	58.5

Notes:
Downloaded from <http://dealerselectric.com>
Generated for Model #.7518ES1BB56C

Performed by

Checked



Dealers Industrial Equipment

No.:

Date: 12-SEP-2016

PERFORMANCE CURVES RELATED TO RATED OUTPUT

Single-phase induction motor - Squirrel cage rotor

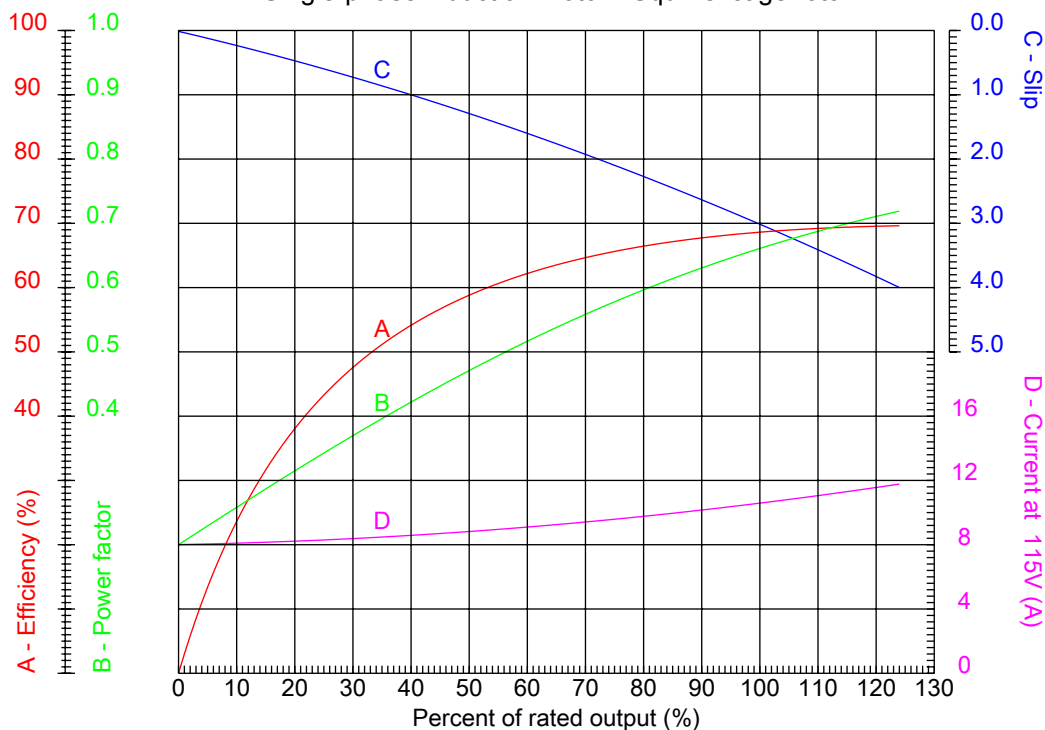

Customer :
 Product line : Single-Phase : NEMA 56 TEFC

Frame : B56	Locked rotor current (I _L /I _n) : 6.2
Output : 0.75 HP	Duty cycle : S1
Frequency : 60 Hz	Service factor : 1.15 (1.00 at 208V)
Full load speed : 1745 rpm	Design : ---
Voltage : 115/208-230 V	Locked rotor torque : 300 %
Rated current : 10.6/5.20-5.30 A	Breakdown torque : 250 %
Insulation class : B	

Notes:
 Downloaded from <http://dealerselectric.com>
 Generated for Model #.7518ES1BB56C

Performed by

Checked

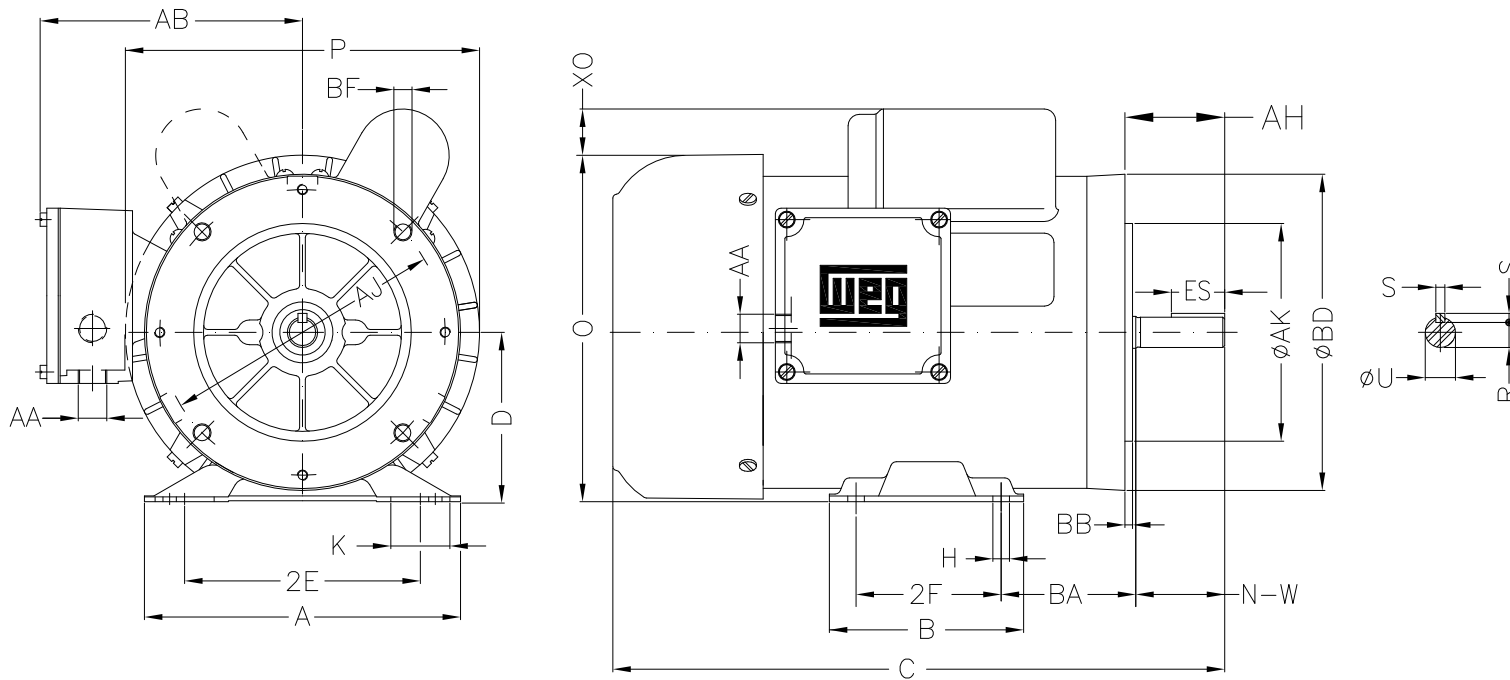

Notes: Downloaded from <http://dealerselectric.com>
Generated for Model #.7518ES1BB56C

Performed by:

Checked:

Customer:

Single-Phase : NEMA 56 TEFC

Single-phase induction motor
Frame B56 - IP55

12-SEP-2016



2E	H	A	2F	B
4.874	0.342	6.535	3.000	4.016
BA	J	P	ES	S
2.750	1.220	7.323	1.102	0.187
depth	N-W	U	R	D
0.187	1.874	0.6250	0.517	3.500
O	XO	C	AA	Flange
7.165	1.063	11.102	2xNPT 1/2"	FC-149
AJ	AK	BD	BF	BB
5.874	4.500	6.535	UNC 3/8"x16-2B	0.157
AH				
2.063				