



Dealers Industrial Equipment

No.:

Date: 12-SEP-2016

Customer :

TECHNICAL PROPOSAL

Single-phase induction motor - Squirrel cage rotor

Product line : Single Phase: W01 (Rolled Steel) - TEFC - Standard Efficiency

Catalog Number : .7518ES1B56CFL-S

List Price : \$370

Notes:

Downloaded from <http://dealerselectric.com>

Generated for Model #.7518ES1B56CFL-S

Performed by:

Checked:



Dealers Industrial Equipment

No.:

Date: 12-SEP-2016

DATA SHEET Single-phase induction motor - Squirrel cage rotor

Customer :
 Product line : Single Phase: W01 (Rolled Steel) - TEFC - Standard Efficiency

Frame : 56
 Output : 0.75 HP
 Frequency : 60 Hz
 Poles : 4
 Full load speed : 1745 rpm
 Slip : 3.06 %
 Voltage : 115/208-230 V
 Rated current : 10.6/5.86-5.30 A
 Locked rotor current : 67.8/33.9 A
 Locked rotor current (I_L/I_n) : 6.4
 No-load current : 8.00/4.00 A
 Full load torque : 2.23 lb.ft
 Locked rotor torque : 300 %
 Breakdown torque : 270 %
 Design : ---
 Insulation class : F
 Temperature rise : 80 K
 Locked rotor time : 10 s (hot)
 Service factor : 1.15
 Duty cycle : S1
 Ambient temperature : -20°C - +40°C
 Altitude : 1000 m
 Degree of Protection : IP55
 Approximate weight : 29 lb
 Moment of inertia : 0.07783 sq.ft.lb
 Noise level : 54 dB(A)

	D.E.	N.D.E.
Bearings	6203 ZZ	6202 ZZ
Regreasing interval	---	---
Grease amount	---	---

Load	Power factor	Efficiency (%)
100%	0.67	68.5
75%	0.58	65.0
50%	0.47	57.0

Notes:
 Downloaded from <http://dealerselectric.com>
 Generated for Model #.7518ES1B56CFL-S

Performed by

Checked



Dealers Industrial Equipment

No.:

Date: 12-SEP-2016

PERFORMANCE CURVES RELATED TO RATED OUTPUT

Single-phase induction motor - Squirrel cage rotor

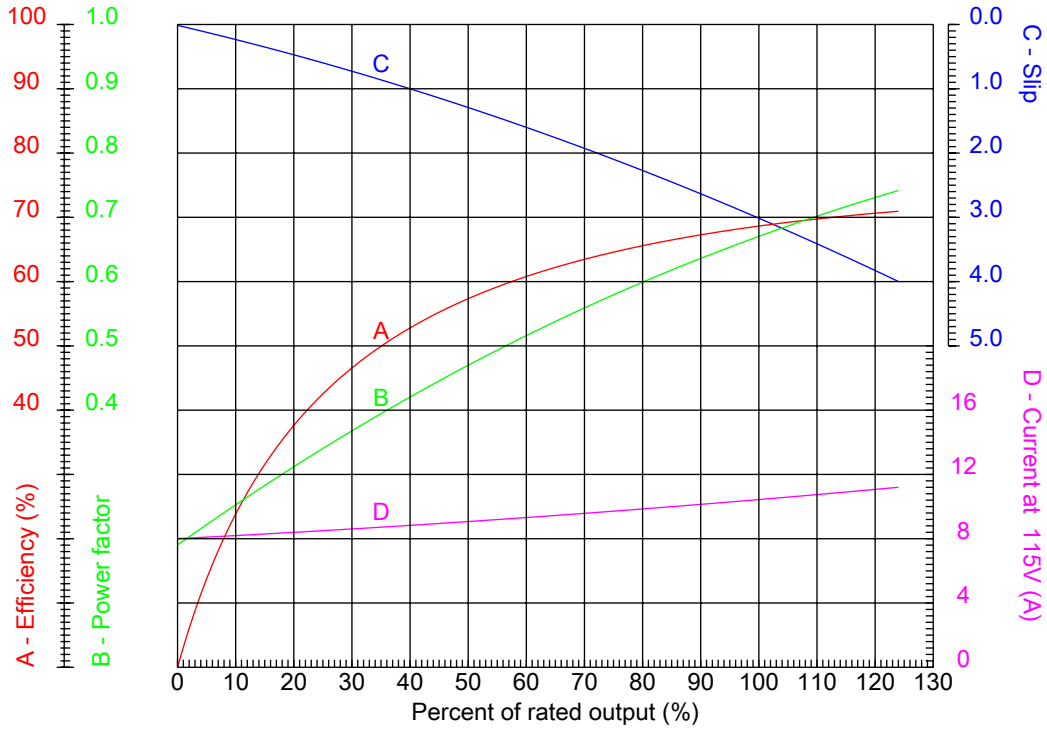

Customer :
 Product line : Single Phase: W01 (Rolled Steel) - TEFC - Standard Efficiency

Frame : 56	Locked rotor current (I _L /I _n) : 6.4
Output : 0.75 HP	Duty cycle : S1
Frequency : 60 Hz	Service factor : 1.15
Full load speed : 1745 rpm	Design : ---
Voltage : 115/208-230 V	Locked rotor torque : 300 %
Rated current : 10.6/5.86-5.30 A	Breakdown torque : 270 %
Insulation class : F	

Notes:
 Downloaded from <http://dealerselectric.com>
 Generated for Model #.7518ES1B56CFL-S

Performed by

Checked

1 2 3 4 5 6 7 8

A

B

C

D

E

F

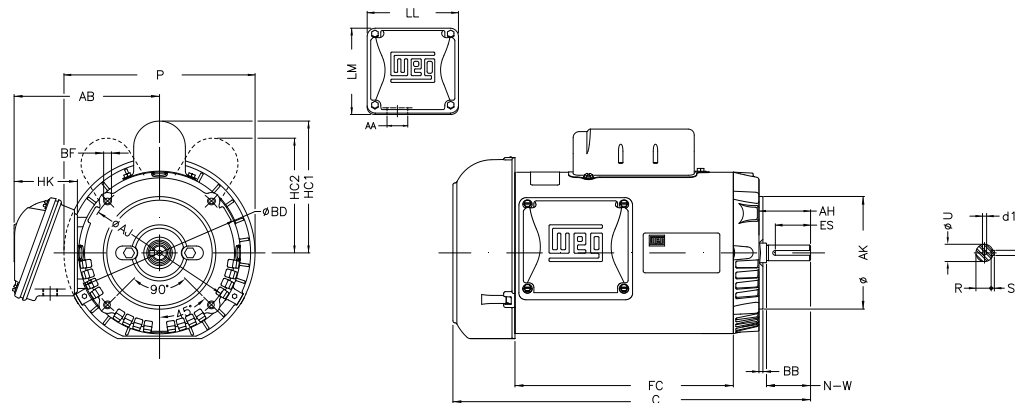

Notes: Downloaded from <http://dealerselectric.com>
Generated for Model #.7518ES1B56CFL-S

Performed by:

Checked:

Customer:

Single Phase: W01 (Rolled Steel) - TEFC - Standard Efficiency

Single-phase induction motor
Frame 56 - IP55

12-SEP-2016



P	AB	HK	FC	C
7.638	5.882	2.638	7.480	13.114
N-W	ES	d1	S	U
1.874	1.417	A 3.15	0.187	0.625
AA	depth	R	LL	LM
0.881"	0.187	0.517	4.543	4.106
CH	HC1	Flange	AJ	AK
1.377	5.122	FC-149	5.874	4.500
BD	BF	BB	AH	
6.450	UNC 3/8"x16-2B	0.157	2.062	