



Dealers Industrial Equipment

No.:

Date: 12-SEP-2016

Customer :

TECHNICAL PROPOSAL

Three-phase induction motor - Squirrel cage rotor

Product line : Jet Pump - NEMA 56 : Three-Phase - Keyed - ODP (IP21)

Catalog Number : .5036OS3EJPR56C

List Price : \$224

Notes:

Downloaded from <http://dealerselectric.com>

Generated for Model #.5036OS3EJPR56C

Performed by:

Checked:



Dealers Industrial Equipment

No.:

Date: 12-SEP-2016

DATA SHEET Three-phase induction motor - Squirrel cage rotor

Customer :
 Product line : Jet Pump - NEMA 56 : Three-Phase - Keyed - ODP (IP21)

Frame : A56
 Output : 0.5 HP
 Frequency : 60 Hz
 Poles : 2
 Full load speed : 3480 rpm
 Slip : 3.33 %
 Voltage : 208-230/460 V
 Rated current : 1.90-1.91/0.957 A
 Locked rotor current : 11.5/5.74 A
 Locked rotor current (I_L/I_n) : 6.0
 No-load current : 1.39/0.693 A
 Full load torque : 0.744 lb.ft
 Locked rotor torque : 250 %
 Breakdown torque : 300 %
 Design : A
 Insulation class : B
 Temperature rise : 80 K
 Locked rotor time : 15 s (hot)
 Service factor : 1.60 (1.00 at 208V)
 Duty cycle : S1
 Ambient temperature : -20°C - +40°C
 Altitude : 1000 m
 Degree of Protection : IP21
 Approximate weight : 24 lb
 Moment of inertia : 0.01946 sq.ft.lb
 Noise level : ---

	D.E.	N.D.E.
Bearings	6203 2RS	6202 2RS
Regreasing interval	---	---
Grease amount	---	---

Load	Power factor	Efficiency (%)
100%	0.77	66.0
75%	0.68	62.5
50%	0.57	55.0

Notes:
 Downloaded from <http://dealerselectric.com>
 Generated for Model #.5036OS3EJPR56C

Performed by

Checked



Dealers Industrial Equipment

No.:

Date: 12-SEP-2016

PERFORMANCE CURVES RELATED TO RATED OUTPUT

Three-phase induction motor - Squirrel cage rotor

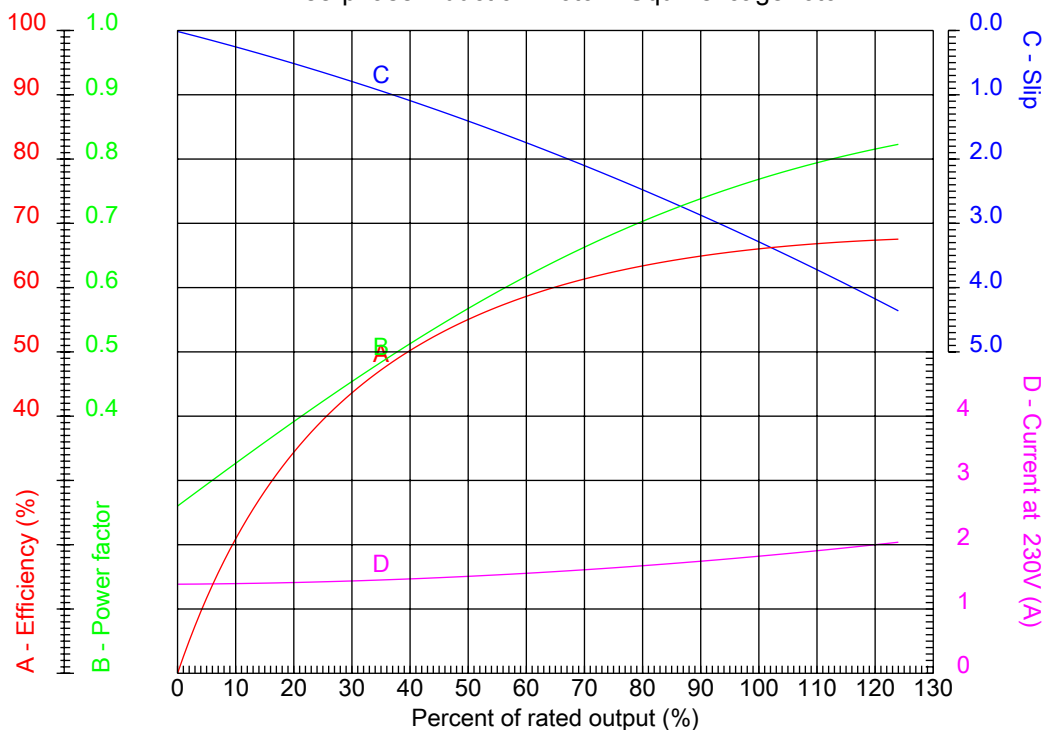

Customer :
 Product line : Jet Pump - NEMA 56 : Three-Phase - Keyed - ODP (IP21)

Frame : A56	Locked rotor current (I _l /I _n) : 6.0
Output : 0.5 HP	Duty cycle : S1
Frequency : 60 Hz	Service factor : 1.60 (1.00 at 208V)
Full load speed : 3480 rpm	Design : A
Voltage : 208-230/460 V	Locked rotor torque : 250 %
Rated current : 1.90-1.91/0.957 A	Breakdown torque : 300 %
Insulation class : B	

Notes:
 Downloaded from <http://dealerselectric.com>
 Generated for Model #.5036OS3EJPR56C

Performed by

Checked



Dealers Industrial Equipment

No.:

Date: 12-SEP-2016

CHARACTERISTIC CURVES RELATED TO SPEED

Three-phase induction motor - Squirrel cage rotor

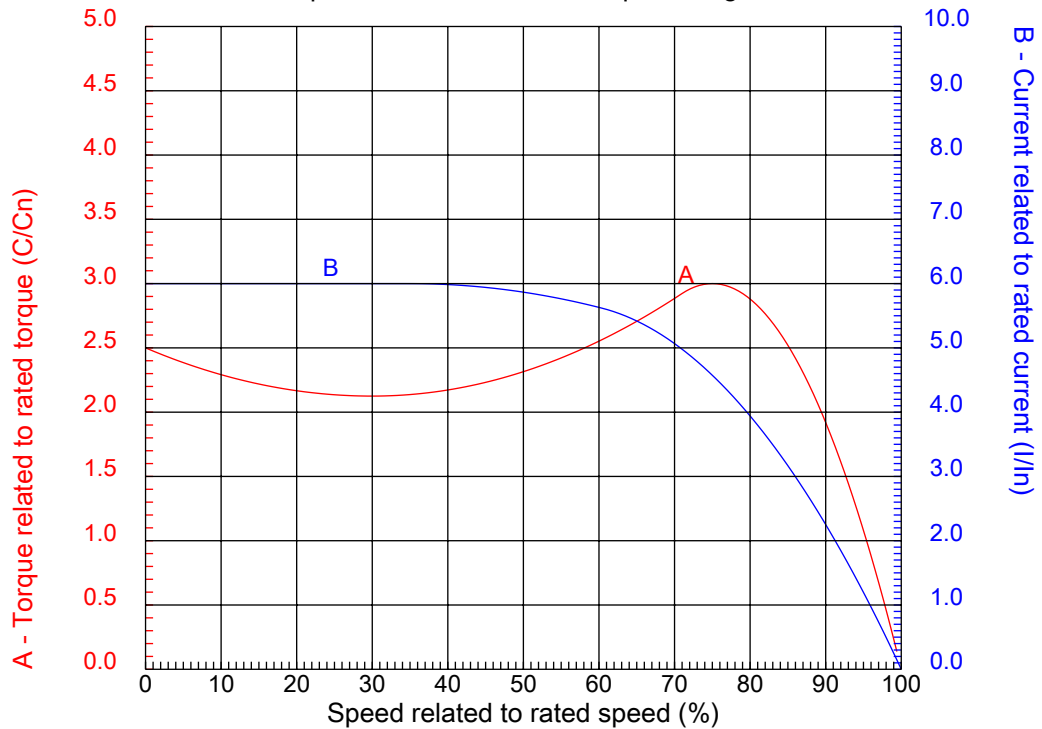

Customer :
Product line : Jet Pump - NEMA 56 : Three-Phase - Keyed - ODP (IP21)

Frame	: A56	Locked rotor current (I _l /I _n)	: 6.0
Output	: 0.5 HP	Duty cycle	: S1
Frequency	: 60 Hz	Service factor	: 1.60 (1.00 at 208V)
Full load speed	: 3480 rpm	Design	: A
Voltage	: 208-230/460 V	Locked rotor torque	: 250 %
Rated current	: 1.90-1.91/0.957 A	Breakdown torque	: 300 %
Insulation class	: B		

Notes:
Downloaded from <http://dealerselectric.com>
Generated for Model #.5036OS3EJPR56C

Performed by

Checked

1 2 3 4 5 6 7 8

A

B

C

D

E

F

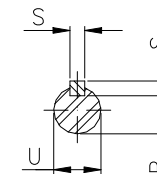
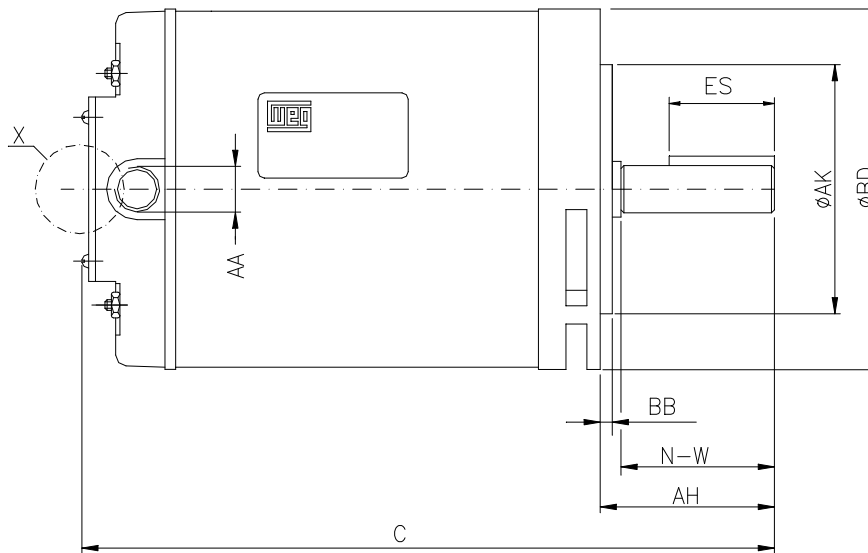
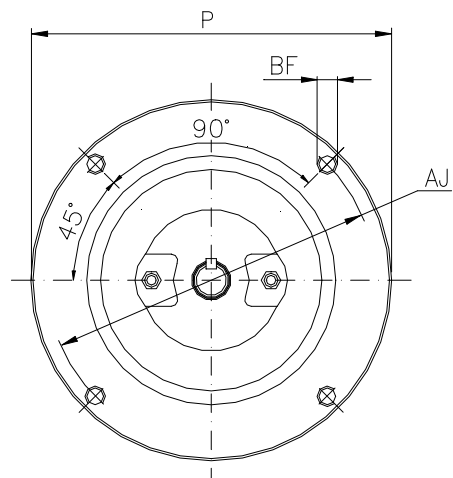

Notes: Downloaded from <http://dealerselectric.com>
Generated for Model #.5036OS3EJPR56C

Performed by:

Checked:

Customer:

Jet Pump - NEMA 56 : Three-Phase - Keyed - ODP (IP21)

C	P	ES	S	N-W
10.315	6.496	1.417	0.187	1.874
U	R	AA	Flange	AJ
0.625	0.517	NPT 1/2"	FC-149	5.874
AK	BD	BF	BB	AH
4.500	6.535	UNC 3/8"x16	0.157	2.063

Three-phase induction motor
Frame A56 - IP21

12-SEP-2016



1 2 3 4 5 6 7 8

A

LOW VOLTAGE

HIGH VOLTAGE

B

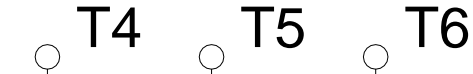
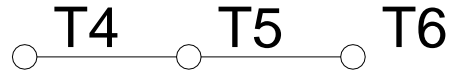

C

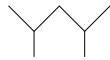

D

E

F

Notes: Downloaded from <http://dealerselectric.com>
 Generated for Model #.5036OS3EJPR56C

Performed by:

Checked:

Customer:

Jet Pump - NEMA 56 : Three-Phase - Keyed - ODP (IP21)

Three-phase induction motor
 Frame A56 - IP21

12-SEP-2016

