



# Dealers Industrial Equipment

No.:

Date: 12-SEP-2016

Customer :

## TECHNICAL PROPOSAL

### Three-phase induction motor - Squirrel cage rotor

Product line : Three-Phase : NEMA 56 Frames - ODP

Catalog Number : .5036OS3EA56

List Price : \$221

#### Notes:

Downloaded from <http://dealerselectric.com>

Generated for Model #.5036OS3EA56

Performed by:

Checked:



# Dealers Industrial Equipment

No.:

Date: 12-SEP-2016

## DATA SHEET Three-phase induction motor - Squirrel cage rotor

Customer :  
Product line : Three-Phase : NEMA 56 Frames - ODP

Frame : A56  
Output : 0.5 HP  
Frequency : 60 Hz  
Poles : 2  
Full load speed : 3480 rpm  
Slip : 3.33 %  
Voltage : 208-230/460 V  
Rated current : 1.85-1.82/0.909 A  
Locked rotor current : 10.9/5.45 A  
Locked rotor current (I<sub>L</sub>/I<sub>n</sub>) : 6.0  
No-load current : 1.39/0.693 A  
Full load torque : 0.744 lb.ft  
Locked rotor torque : 250 %  
Breakdown torque : 300 %  
Design : A  
Insulation class : B  
Temperature rise : 80 K  
Locked rotor time : 15 s (hot)  
Service factor : 1.25 (1.00 at 208V)  
Duty cycle : S1  
Ambient temperature : -20°C - +40°C  
Altitude : 1000 m  
Degree of Protection : IP21  
Approximate weight : 20 lb  
Moment of inertia : 0.01946 sq.ft.lb  
Noise level : ---

	D.E.	N.D.E.
Bearings	6204 ZZ	6203 ZZ
Regreasing interval	---	---
Grease amount	---	---

Load	Power factor	Efficiency (%)
100%	0.77	66.0
75%	0.68	62.5
50%	0.57	55.0

Notes:  
Downloaded from <http://dealerselectric.com>  
Generated for Model #.5036OS3EA56

Performed by

Checked



# Dealers Industrial Equipment

No.:

Date: 12-SEP-2016

## PERFORMANCE CURVES RELATED TO RATED OUTPUT

Three-phase induction motor - Squirrel cage rotor

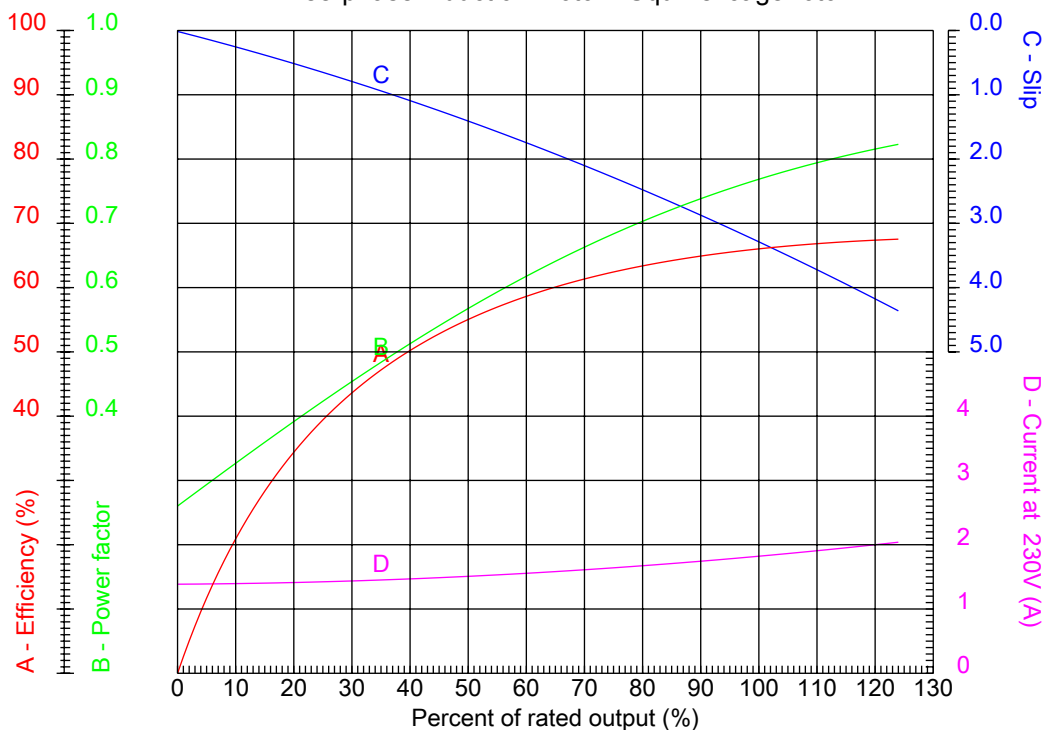

Customer :  
 Product line : Three-Phase : NEMA 56 Frames - ODP

Frame : A56	Locked rotor current (I <sub>L</sub> /I <sub>n</sub> ) : 6.0
Output : 0.5 HP	Duty cycle : S1
Frequency : 60 Hz	Service factor : 1.25 (1.00 at 208V)
Full load speed : 3480 rpm	Design : A
Voltage : 208-230/460 V	Locked rotor torque : 250 %
Rated current : 1.85-1.82/0.909 A	Breakdown torque : 300 %
Insulation class : B	

Notes:  
 Downloaded from <http://dealerselectric.com>  
 Generated for Model #.5036OS3EA56

Performed by

Checked



# Dealers Industrial Equipment

No.:

Date: 12-SEP-2016

## CHARACTERISTIC CURVES RELATED TO SPEED

Three-phase induction motor - Squirrel cage rotor

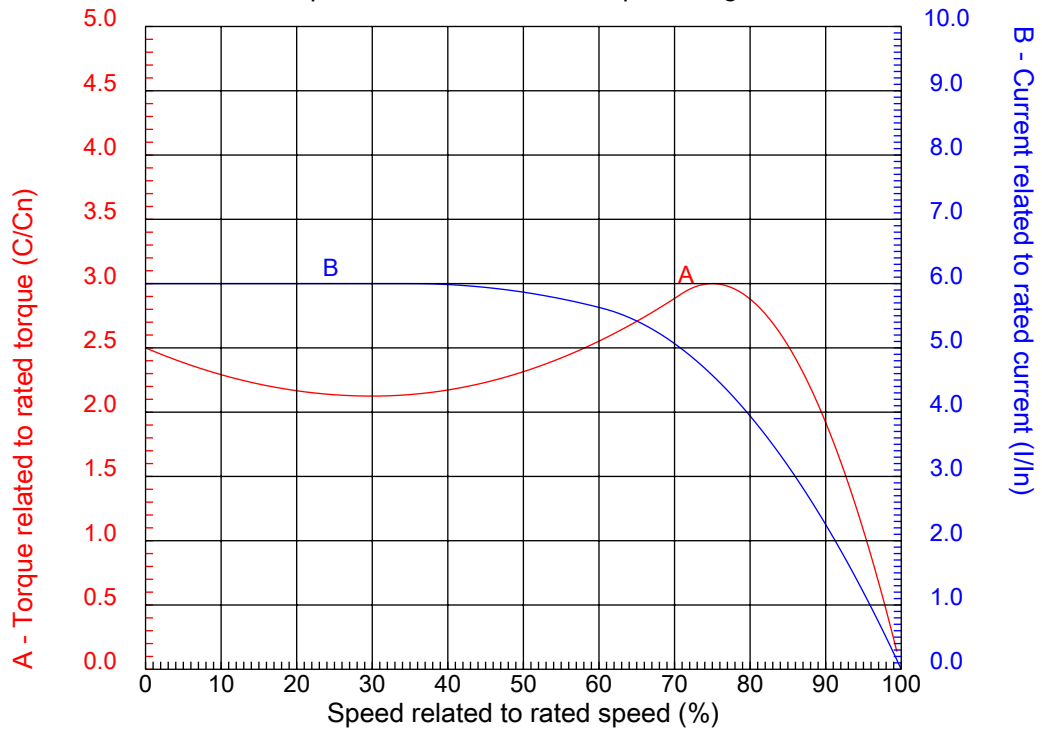

Customer :  
Product line : Three-Phase : NEMA 56 Frames - ODP

Frame	: A56	Locked rotor current (I <sub>l</sub> /I <sub>n</sub> )	: 6.0
Output	: 0.5 HP	Duty cycle	: S1
Frequency	: 60 Hz	Service factor	: 1.25 (1.00 at 208V)
Full load speed	: 3480 rpm	Design	: A
Voltage	: 208-230/460 V	Locked rotor torque	: 250 %
Rated current	: 1.85-1.82/0.909 A	Breakdown torque	: 300 %
Insulation class	: B		

Notes:  
Downloaded from <http://dealerselectric.com>  
Generated for Model #.5036OS3EA56

Performed by

Checked

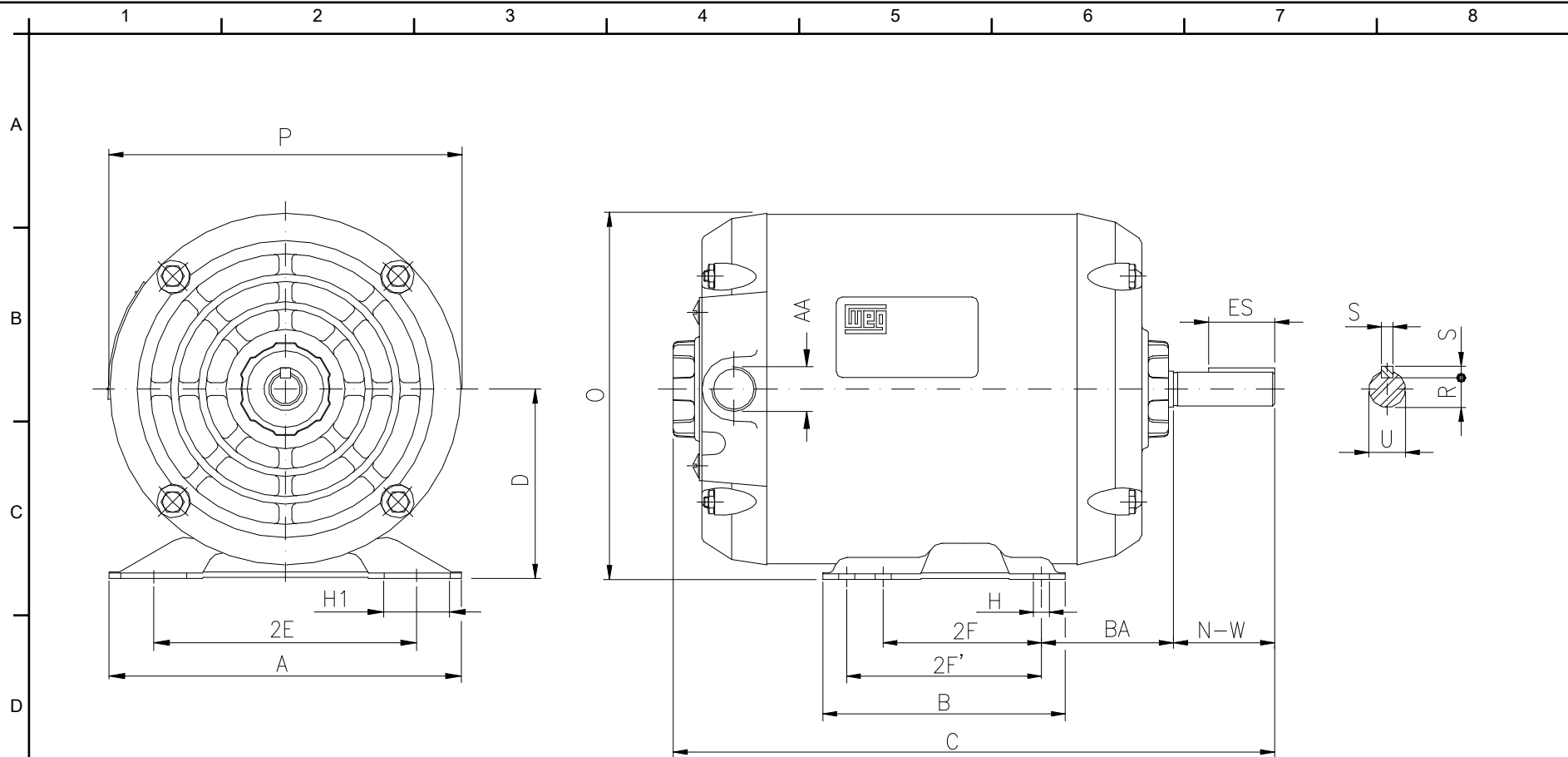

Notes: Downloaded from <http://dealerselectric.com>  
 Generated for Model #.5036OS3EA56

Performed by:

Checked:

Customer:

Three-Phase : NEMA 56 Frames - ODP

Three-phase induction motor  
 Frame A56 - IP21

12-SEP-2016



2E 4.874	H 0.342	A 6.535	2F 3.000	B 6.496
G 3.04	BA 2.750	J 1.220	P 6.496	ES 1.102
S 0.187	N-W 1.874	depth 0.187	U 0.6250	R 0.517
D 3.500	O 6.771	C 10.315	AA NPT 1/2"	

1 2 3 4 5 6 7 8

A

### LOW VOLTAGE

### HIGH VOLTAGE

B

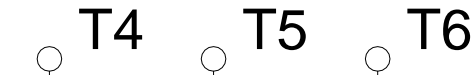

C

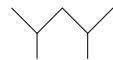

D

E

F

Notes: Downloaded from <http://dealerselectric.com>  
 Generated for Model #.5036OS3EA56

Performed by:

Checked:

Customer:

Three-Phase : NEMA 56 Frames - ODP

Three-phase induction motor  
 Frame A56 - IP21

12-SEP-2016

