



Dealers Industrial Equipment

No.:

Date: 12-SEP-2016

Customer :

TECHNICAL PROPOSAL

Three-phase induction motor - Squirrel cage rotor

Product line : Three-Phase : NEMA 56 Frames - TEFC

Catalog Number : .5036ES3EB56C

List Price : \$282

Notes:

Downloaded from <http://dealerselectric.com>

Generated for Model #.5036ES3EB56C

Performed by:

Checked:



Dealers Industrial Equipment

No.:

Date: 12-SEP-2016

DATA SHEET Three-phase induction motor - Squirrel cage rotor

Customer :
Product line : Three-Phase : NEMA 56 Frames - TEFC

Frame : B56
Output : 0.5 HP
Frequency : 60 Hz
Poles : 2
Full load speed : 3470 rpm
Slip : 3.61 %
Voltage : 208-230/460 V
Rated current : 1.75-1.70/0.850 A
Locked rotor current : 13.6/6.80 A
Locked rotor current (I_L/I_n) : 8.0
No-load current : 1.00/0.500 A
Full load torque : 0.747 lb.ft
Locked rotor torque : 430 %
Breakdown torque : 440 %
Design : A
Insulation class : F
Temperature rise : 80 K
Locked rotor time : 10 s (hot)
Service factor : 1.15 (1.00 at 208V)
Duty cycle : S1
Ambient temperature : -20°C - +40°C
Altitude : 1000 m
Degree of Protection : IP55
Approximate weight : 23 lb
Moment of inertia : 0.03156 sq.ft.lb
Noise level : ---

	D.E.	N.D.E.
Bearings	6203 ZZ	6202 ZZ
Regreasing interval	---	---
Grease amount	---	---

Load	Power factor	Efficiency (%)
100%	0.80	70.0
75%	0.74	66.0
50%	0.64	57.5

Notes:
Downloaded from <http://dealerselectric.com>
Generated for Model #.5036ES3EB56C

Performed by

Checked



Dealers Industrial Equipment

No.:

Date: 12-SEP-2016

PERFORMANCE CURVES RELATED TO RATED OUTPUT Three-phase induction motor - Squirrel cage rotor

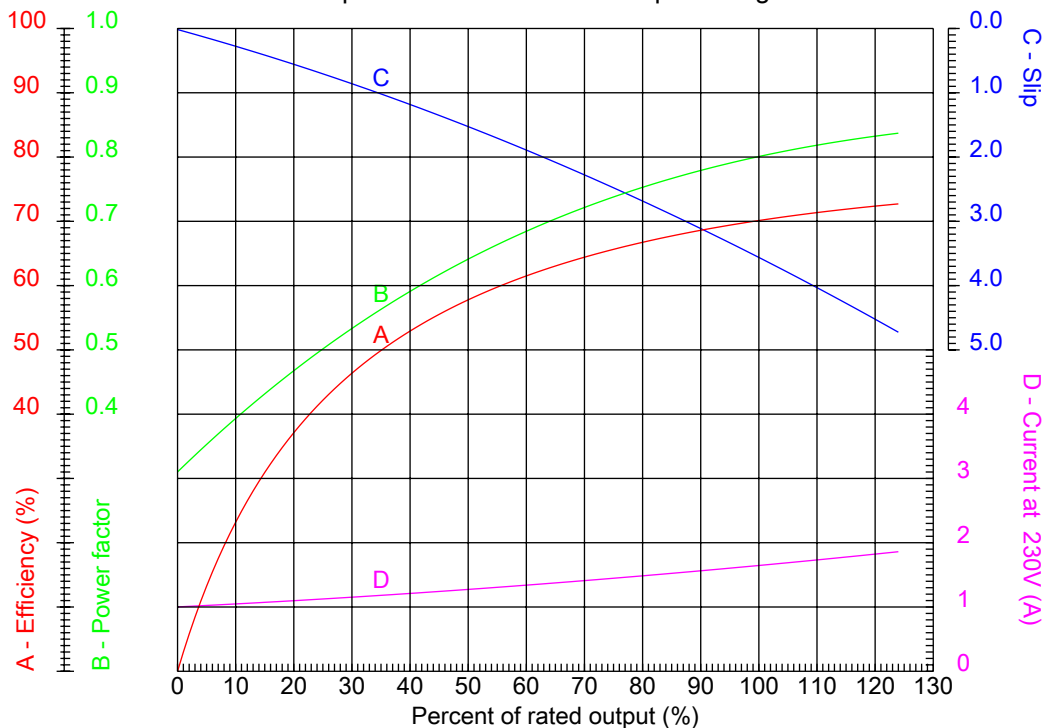

Customer :
 Product line : Three-Phase : NEMA 56 Frames - TEFC

Frame	: B56	Locked rotor current (I _L /I _n)	: 8.0
Output	: 0.5 HP	Duty cycle	: S1
Frequency	: 60 Hz	Service factor	: 1.15 (1.00 at 208V)
Full load speed	: 3470 rpm	Design	: A
Voltage	: 208-230/460 V	Locked rotor torque	: 430 %
Rated current	: 1.75-1.70/0.850 A	Breakdown torque	: 440 %
Insulation class	: F		

Notes:
 Downloaded from <http://dealerselectric.com>
 Generated for Model #.5036ES3EB56C

Performed by

Checked



Dealers Industrial Equipment

No.:

Date: 12-SEP-2016

CHARACTERISTIC CURVES RELATED TO SPEED

Three-phase induction motor - Squirrel cage rotor

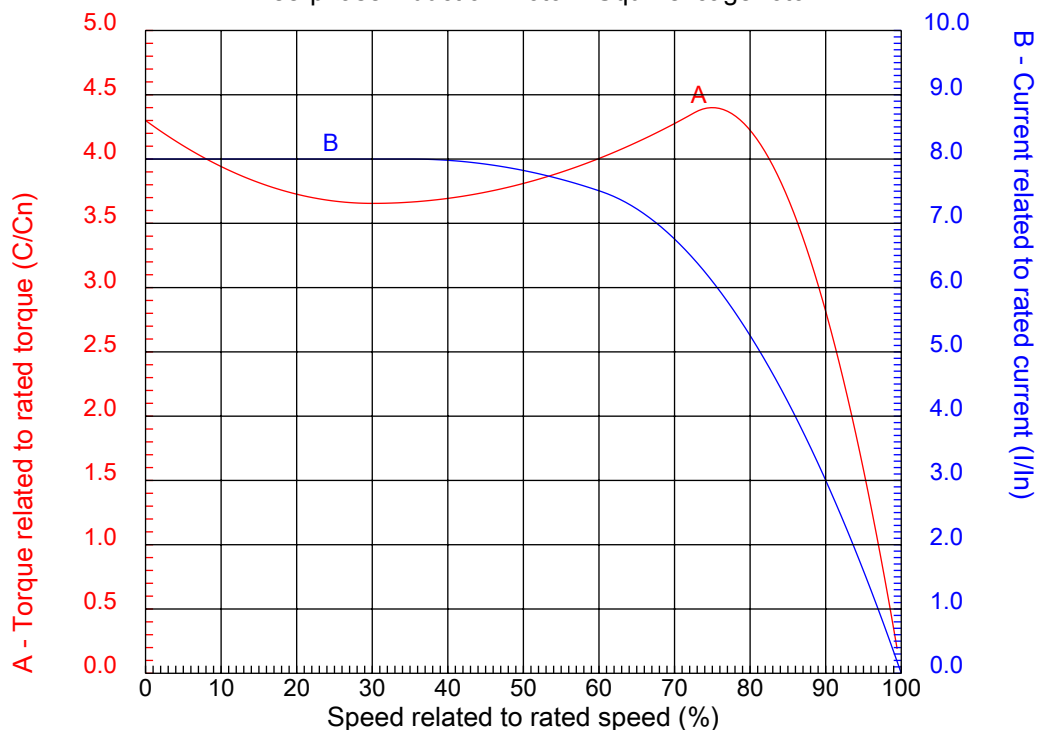

Customer :
Product line : Three-Phase : NEMA 56 Frames - TEFC

Frame	: B56	Locked rotor current (I _l /I _n)	: 8.0
Output	: 0.5 HP	Duty cycle	: S1
Frequency	: 60 Hz	Service factor	: 1.15 (1.00 at 208V)
Full load speed	: 3470 rpm	Design	: A
Voltage	: 208-230/460 V	Locked rotor torque	: 430 %
Rated current	: 1.75-1.70/0.850 A	Breakdown torque	: 440 %
Insulation class	: F		

Notes:
Downloaded from <http://dealerselectric.com>
Generated for Model #.5036ES3EB56C

Performed by

Checked

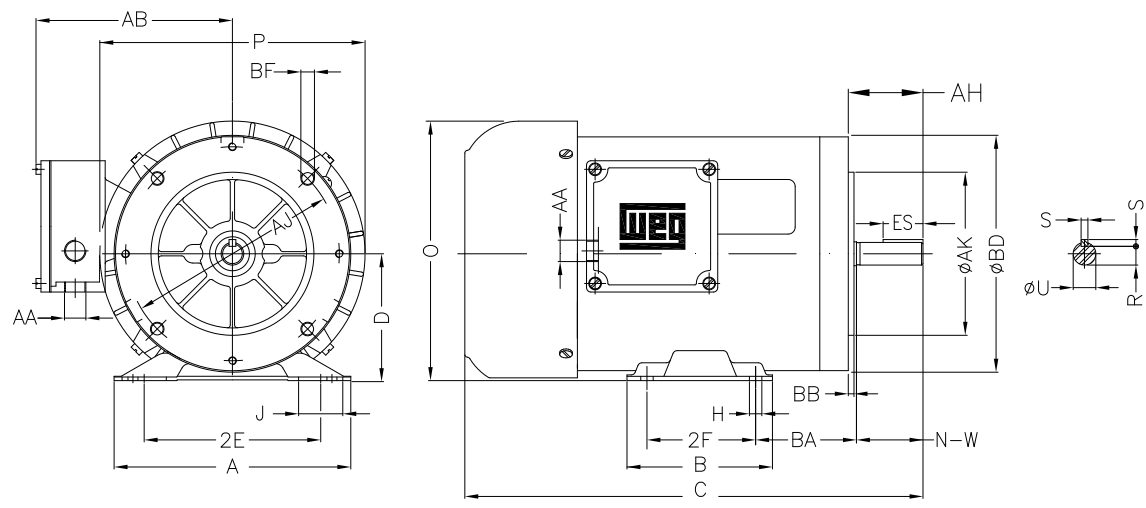

Notes: Downloaded from <http://dealerselectric.com>
 Generated for Model #.5036ES3EB56C

Performed by:

Checked:

Customer:

Three-Phase : NEMA 56 Frames - TEFC

Three-phase induction motor
 Frame B56 - IP55

12-SEP-2016



2E	2F	H	H1	BA
4.874	3.000	0.342	1.220	2.750
A	B	C	D	J
6.535	4.016	11.102	3.500	1.220
O	P	S	ES	R
7.165	7.323	0.187	1.102	0.517
N-W	U	AB	AA	Flange
1.874	0.6250	5.433	2xNPT 1/2"	FC-149
AJ	AK	BD	BF	BB
5.874	4.500	6.535	UNC 3/8"x16-2B	0.157
AH				
2.063				

1 2 3 4 5 6 7 8

A

LOW VOLTAGE

HIGH VOLTAGE

B



C



D

E

F

Notes: Downloaded from <http://dealerselectric.com>
 Generated for Model #.5036ES3EB56C

Performed by:

Checked:

Customer:

Three-Phase : NEMA 56 Frames - TEFC

Three-phase induction motor
 Frame B56 - IP55

12-SEP-2016

