



Dealers Industrial Equipment

No.:

Date: 12-SEP-2016

Customer :

TECHNICAL PROPOSAL

Single-phase induction motor - Squirrel cage rotor

Product line : Single-Phase : NEMA 48 & 56 ODP - Start Capacitor

Catalog Number : .5018OS1BC48

List Price : \$273

Notes:

Downloaded from <http://dealerselectric.com>

Generated for Model #.5018OS1BC48

Performed by:

Checked:



Dealers Industrial Equipment

No.:

Date: 12-SEP-2016

DATA SHEET Single-phase induction motor - Squirrel cage rotor

Customer :
Product line : Single-Phase : NEMA 48 & 56 ODP - Start Capacitor

Frame : C48
Output : 0.5 HP
Frequency : 60 Hz
Poles : 4
Full load speed : 1730 rpm
Slip : 3.89 %
Voltage : 115/208-230 V
Rated current : 8.50/4.10-4.25 A
Locked rotor current : 45.9/23.0 A
Locked rotor current (I_L/I_n) : 5.4
No-load current : 6.80/3.40 A
Full load torque : 1.50 lb.ft
Locked rotor torque : 330 %
Breakdown torque : 240 %
Design : ---
Insulation class : B
Temperature rise : 80 K
Locked rotor time : 6 s (hot)
Service factor : 1.25 (1.00 at 208V)
Duty cycle : S1
Ambient temperature : -20°C - +40°C
Altitude : 1000 m
Degree of Protection : IP21
Approximate weight : 24 lb
Moment of inertia : 0.04817 sq.ft.lb
Noise level : ---

	D.E.	N.D.E.
Bearings	6203 ZZ	6202 ZZ
Regreasing interval	---	---
Grease amount	---	---

Load	Power factor	Efficiency (%)
100%	0.61	61.7
75%	0.52	59.0
50%	0.43	53.0

Notes:
Downloaded from <http://dealerselectric.com>
Generated for Model #.5018OS1BC48

Performed by

Checked



Dealers Industrial Equipment

No.:

Date: 12-SEP-2016

PERFORMANCE CURVES RELATED TO RATED OUTPUT

Single-phase induction motor - Squirrel cage rotor

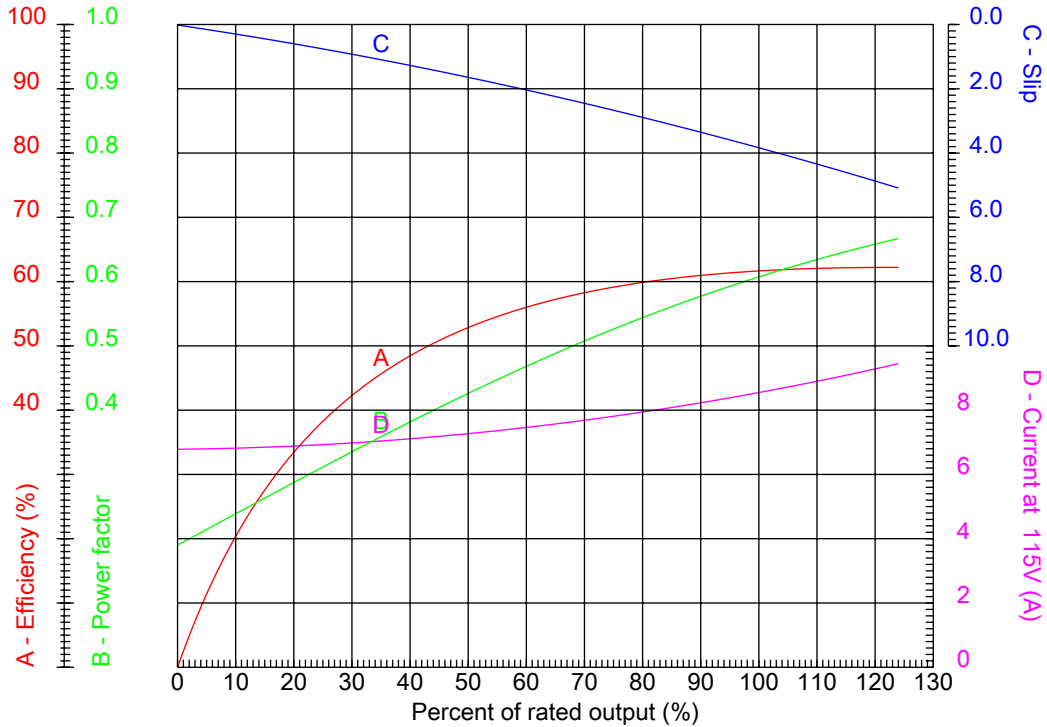

Customer :
 Product line : Single-Phase : NEMA 48 & 56 ODP - Start Capacitor

Frame : C48	Locked rotor current (I _L /I _n) : 5.4
Output : 0.5 HP	Duty cycle : S1
Frequency : 60 Hz	Service factor : 1.25 (1.00 at 208V)
Full load speed : 1730 rpm	Design : ---
Voltage : 115/208-230 V	Locked rotor torque : 330 %
Rated current : 8.50/4.10-4.25 A	Breakdown torque : 240 %
Insulation class : B	

Notes:
 Downloaded from <http://dealerselectric.com>
 Generated for Model #.5018OS1BC48

Performed by

Checked

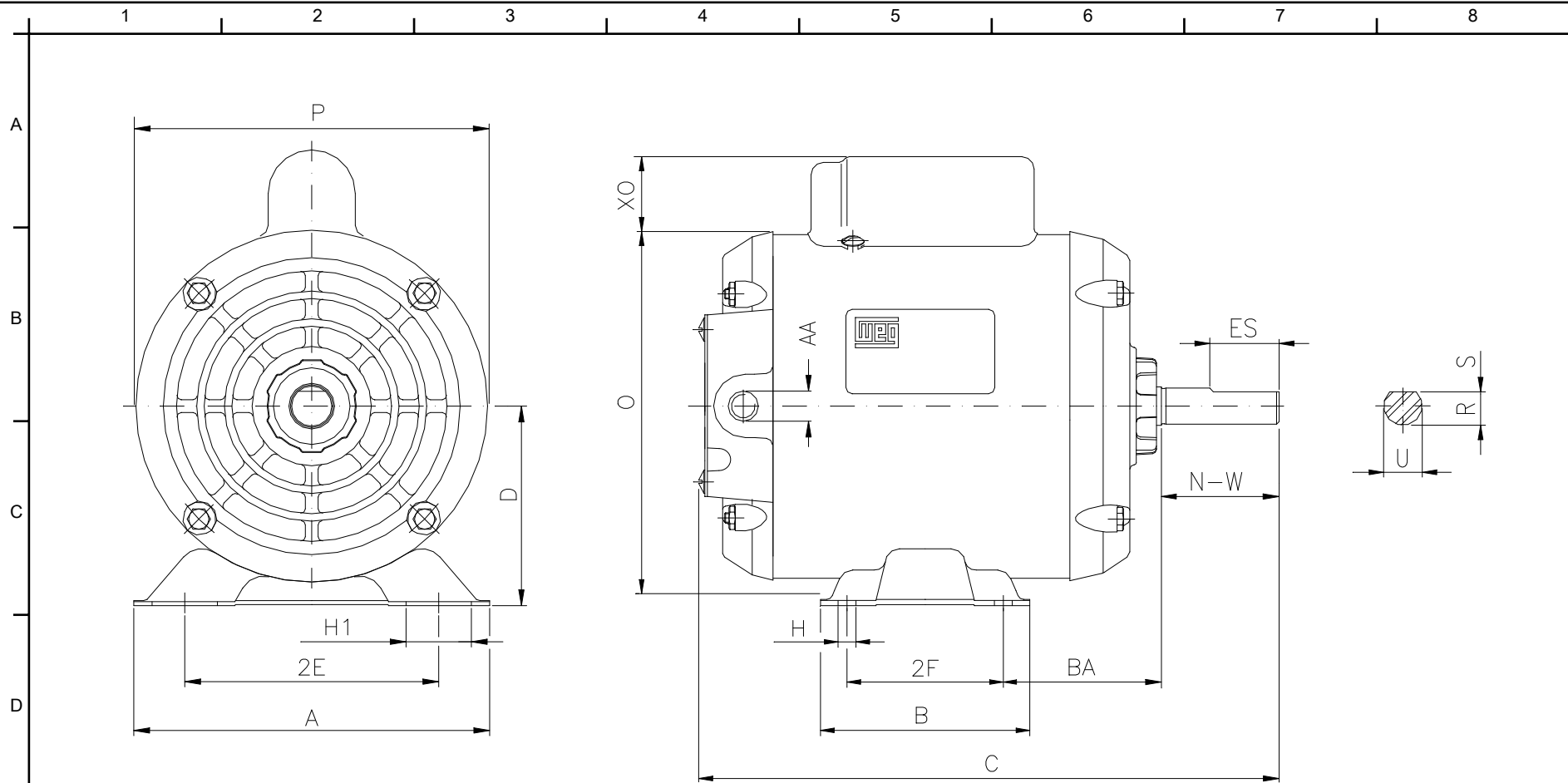

Notes: Downloaded from <http://dealerselectric.com>
 Generated for Model #.5018OS1BC48

Performed by:

Checked:

Customer:

Single-Phase : NEMA 48 & 56 ODP - Start Capacitor

2E 4.236	2F 2.748	H 0.342	H1 31	BA 2.500
A 6.142	B 3.543	C 10.197	D 3.000	O 5.905
XO 0.000	P 5.708	ES 1.260	N-W 1.500	U 0.5000
R 0.453	AA NPT 1/2"	AH 1.689		

Single-phase induction motor
 Frame C48 - IP21

12-SEP-2016

