



Dealers Industrial Equipment

No.:

Date: 12-SEP-2016

Customer :

TECHNICAL PROPOSAL

Three-phase induction motor - Squirrel cage rotor

Product line : Three-Phase : NEMA 56 Frames - ODP

Catalog Number : .5012OS3EB56C

List Price : \$328

Notes:

Downloaded from <http://dealerselectric.com>

Generated for Model #.5012OS3EB56C

Performed by:

Checked:



Dealers Industrial Equipment

No.:

Date: 12-SEP-2016

DATA SHEET Three-phase induction motor - Squirrel cage rotor

Customer :
Product line : Three-Phase : NEMA 56 Frames - ODP

Frame : B56
Output : 0.5 HP
Frequency : 60 Hz
Poles : 6
Full load speed : 1140 rpm
Slip : 5.00 %
Voltage : 208-230/460 V
Rated current : 2.00-2.00/1.00 A
Locked rotor current : 9.00/4.50 A
Locked rotor current (I_L/I_n) : 4.5
No-load current : 1.60/0.800 A
Full load torque : 2.27 lb.ft
Locked rotor torque : 250 %
Breakdown torque : 270 %
Design : A
Insulation class : B
Temperature rise : 80 K
Locked rotor time : 15 s (hot)
Service factor : 1.25 (1.00 at 208V)
Duty cycle : S1
Ambient temperature : -20°C - +40°C
Altitude : 1000 m
Degree of Protection : IP21
Approximate weight : 26 lb
Moment of inertia : 0.07119 sq.ft.lb
Noise level : ---

	D.E.	N.D.E.
Bearings	6204 ZZ	6203 ZZ
Regreasing interval	---	---
Grease amount	---	---

Load	Power factor	Efficiency (%)
100%	0.65	68.0
75%	0.55	67.5
50%	0.44	59.0

Notes:
Downloaded from <http://dealerselectric.com>
Generated for Model #.5012OS3EB56C

Performed by

Checked



Dealers Industrial Equipment

No.:

Date: 12-SEP-2016

PERFORMANCE CURVES RELATED TO RATED OUTPUT

Three-phase induction motor - Squirrel cage rotor

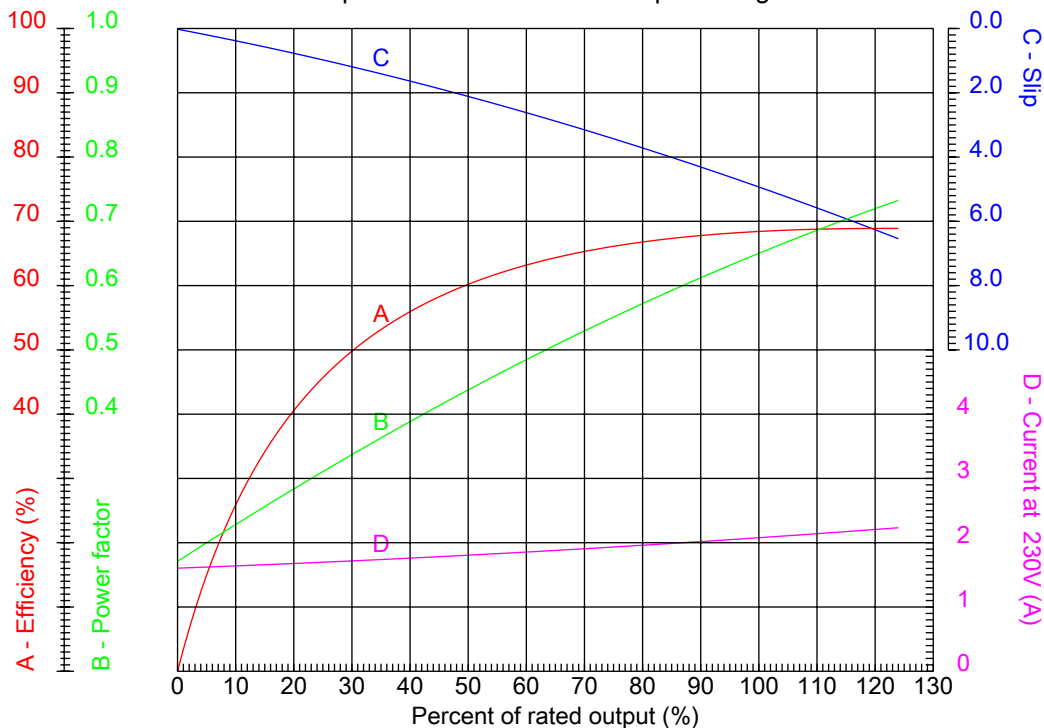

Customer :
 Product line : Three-Phase : NEMA 56 Frames - ODP

Frame	: B56	Locked rotor current (I _L /I _n)	: 4.5
Output	: 0.5 HP	Duty cycle	: S1
Frequency	: 60 Hz	Service factor	: 1.25 (1.00 at 208V)
Full load speed	: 1140 rpm	Design	: A
Voltage	: 208-230/460 V	Locked rotor torque	: 250 %
Rated current	: 2.00-2.00/1.00 A	Breakdown torque	: 270 %
Insulation class	: B		

Notes:
 Downloaded from <http://dealerselectric.com>
 Generated for Model #.5012OS3EB56C

Performed by

Checked



Dealers Industrial Equipment

No.:

Date: 12-SEP-2016

CHARACTERISTIC CURVES RELATED TO SPEED

Three-phase induction motor - Squirrel cage rotor

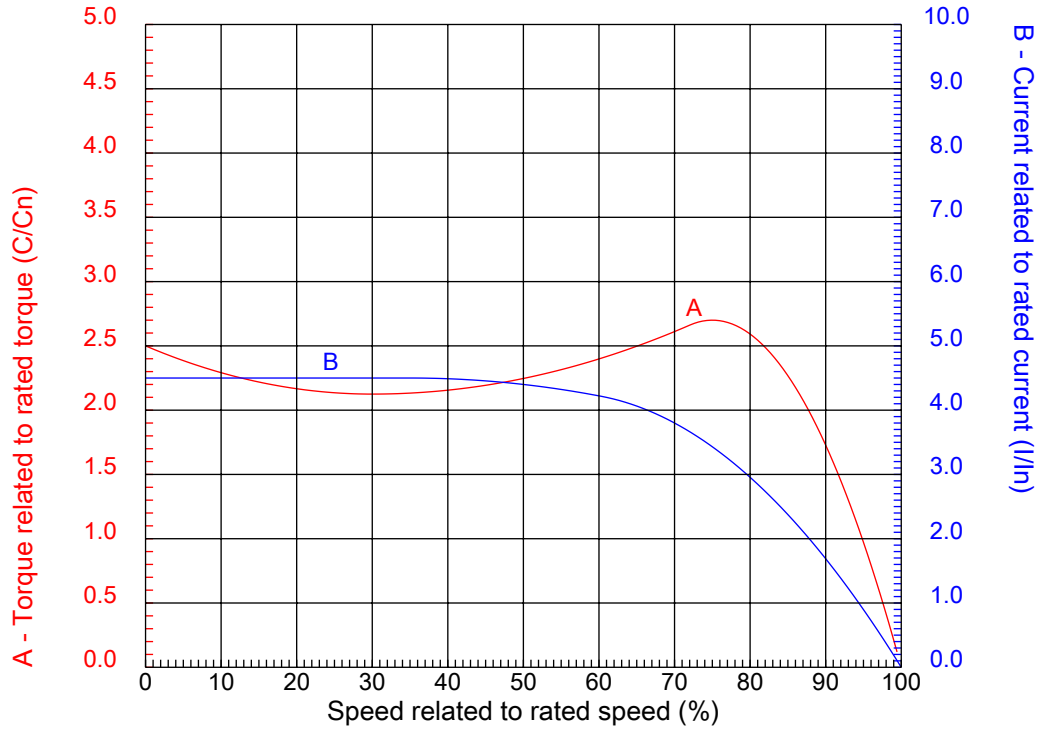

Customer :
Product line : Three-Phase : NEMA 56 Frames - ODP

Frame	: B56	Locked rotor current (I _l /I _n)	: 4.5
Output	: 0.5 HP	Duty cycle	: S1
Frequency	: 60 Hz	Service factor	: 1.25 (1.00 at 208V)
Full load speed	: 1140 rpm	Design	: A
Voltage	: 208-230/460 V	Locked rotor torque	: 250 %
Rated current	: 2.00-2.00/1.00 A	Breakdown torque	: 270 %
Insulation class	: B		

Notes:
Downloaded from <http://dealerselectric.com>
Generated for Model #.5012OS3EB56C

Performed by

Checked

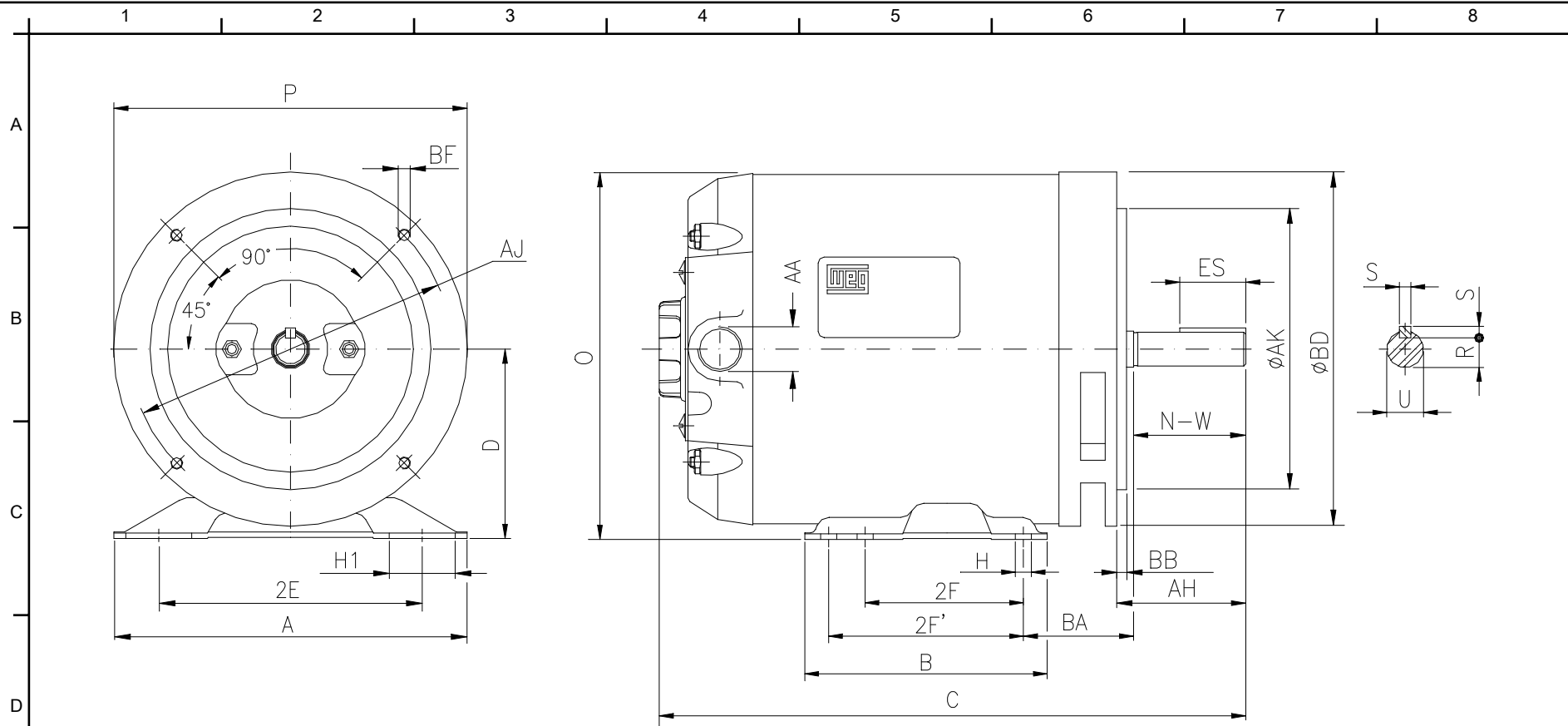

Notes: Downloaded from <http://dealerselectric.com>
 Generated for Model #.5012OS3EB56C

Performed by:

Checked:

Customer:

Three-Phase : NEMA 56 Frames - ODP

2E 4.874	H 0.342	A 6.535	2F 3.000	B 4.016
BA 2.750	J 1.220	P 6.457	ES 1.102	S 0.187
N-W 1.874	depth 0.187	U 0.6250	R 0.517	d1 A 3,15
D 3.500	O 6.732	C 11.102	AA NPT 1/2"	Flange FC-149
AJ 5.874	AK 4.500	BD 6.500	BF UNC 3/8"x16-2B	BB 0.157

Three-phase induction motor
 Frame B56 - IP21

12-SEP-2016



1 2 3 4 5 6 7 8

A

LOW VOLTAGE

HIGH VOLTAGE

B

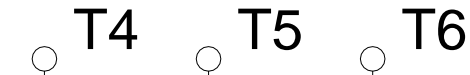
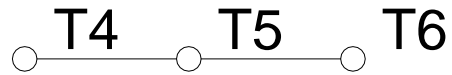

C

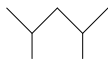
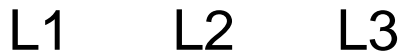

D

E

F

Notes: Downloaded from <http://dealerselectric.com>
 Generated for Model #.5012OS3EB56C

Performed by:

Checked:

Customer:

Three-Phase : NEMA 56 Frames - ODP

Three-phase induction motor
 Frame B56 - IP21

12-SEP-2016

