



Dealers Industrial Equipment

No.:

Date: 12-SEP-2016

Customer :

TECHNICAL PROPOSAL

Three-phase induction motor - Squirrel cage rotor

Product line : Three-Phase: Fractional Explosion Proof Motors

Catalog Number : .3336XS3E56

List Price : \$650

Notes:

Downloaded from <http://dealerselectric.com>

Generated for Model #.3336XS3E56

Performed by:

Checked:



Dealers Industrial Equipment

No.:

Date: 12-SEP-2016

DATA SHEET Three-phase induction motor - Squirrel cage rotor

Customer :
 Product line : Three-Phase: Fractional Explosion Proof Motors

Frame : 56
 Output : 0.33 HP
 Frequency : 60 Hz
 Poles : 2
 Full load speed : 3450 rpm
 Slip : 4.17 %
 Voltage : 208-230/460 V
 Rated current : 1.15-1.04/0.522 A
 Locked rotor current : 6.47/3.24 A
 Locked rotor current (I_L/I_n) : 6.2
 No-load current : 0.800/0.400 A
 Full load torque : 0.496 lb.ft
 Locked rotor torque : 240 %
 Breakdown torque : 350 %
 Design : A
 Insulation class : F
 Temperature rise : 80 K
 Locked rotor time : 13 s (hot)
 Service factor : 1.00
 Duty cycle : S1
 Ambient temperature : -20°C - +50°C
 Altitude : 1000 m
 Degree of Protection : IP55
 Approximate weight : 18 lb
 Moment of inertia : 0.00759 sq.ft.lb
 Noise level : ---

	D.E.	N.D.E.
Bearings	6203 ZZ	6203 ZZ
Regreasing interval	---	---
Grease amount	---	---

Load	Power factor	Efficiency (%)
100%	0.80	75.1
75%	0.72	74.0
50%	0.59	69.0

Notes:
 Downloaded from <http://dealerselectric.com>
 Generated for Model #.3336XS3E56

Performed by

Checked



Dealers Industrial Equipment

No.:

Date: 12-SEP-2016

PERFORMANCE CURVES RELATED TO RATED OUTPUT

Three-phase induction motor - Squirrel cage rotor

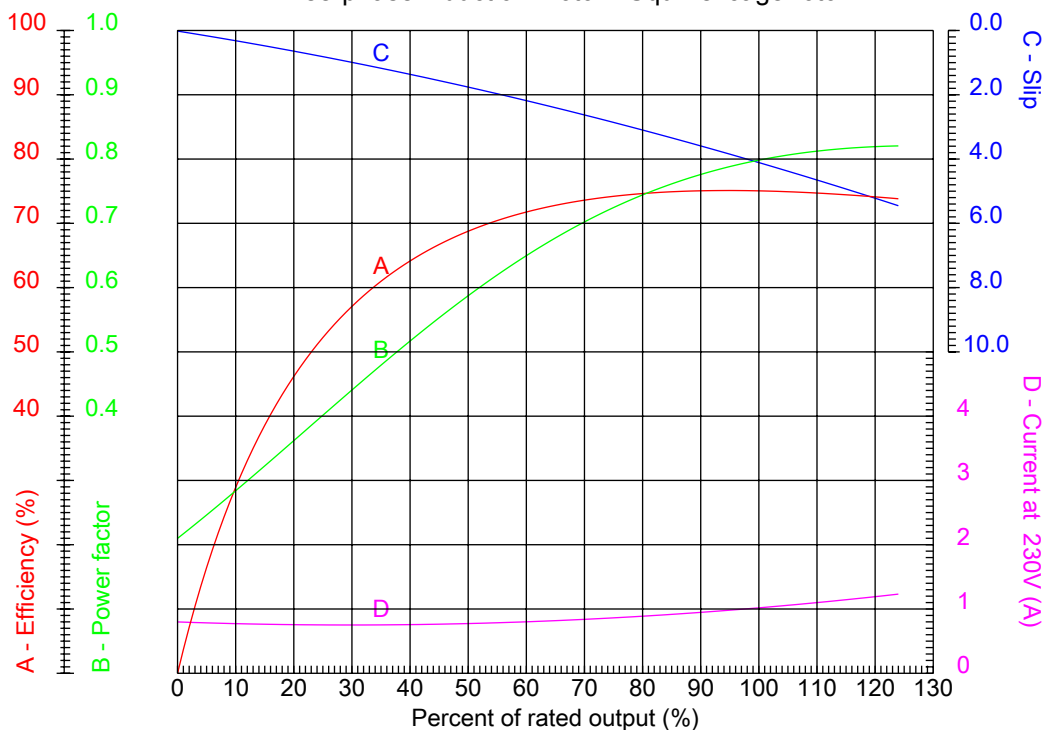

Customer :
 Product line : Three-Phase: Fractional Explosion Proof Motors

Frame	: 56	Locked rotor current (I _L /I _n)	: 6.2
Output	: 0.33 HP	Duty cycle	: S1
Frequency	: 60 Hz	Service factor	: 1.00
Full load speed	: 3450 rpm	Design	: A
Voltage	: 208-230/460 V	Locked rotor torque	: 240 %
Rated current	: 1.15-1.04/0.522 A	Breakdown torque	: 350 %
Insulation class	: F		

Notes:
 Downloaded from <http://dealerselectric.com>
 Generated for Model #.3336XS3E56

Performed by

Checked



Dealers Industrial Equipment

No.:

Date: 12-SEP-2016

CHARACTERISTIC CURVES RELATED TO SPEED

Three-phase induction motor - Squirrel cage rotor

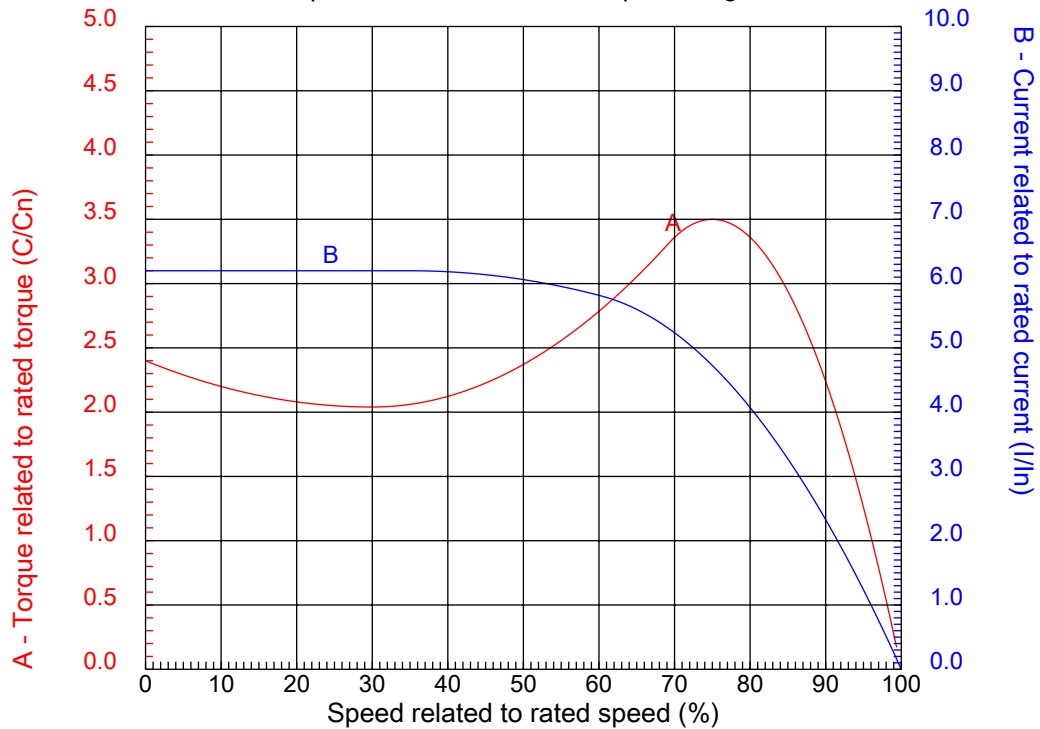

Customer :
Product line : Three-Phase: Fractional Explosion Proof Motors

Frame	: 56	Locked rotor current (I _l /I _n)	: 6.2
Output	: 0.33 HP	Duty cycle	: S1
Frequency	: 60 Hz	Service factor	: 1.00
Full load speed	: 3450 rpm	Design	: A
Voltage	: 208-230/460 V	Locked rotor torque	: 240 %
Rated current	: 1.15-1.04/0.522 A	Breakdown torque	: 350 %
Insulation class	: F		

Notes:
Downloaded from <http://dealerselectric.com>
Generated for Model #.3336XS3E56

Performed by

Checked

1 2 3 4 5 6 7 8

A

B

C

D

E

F

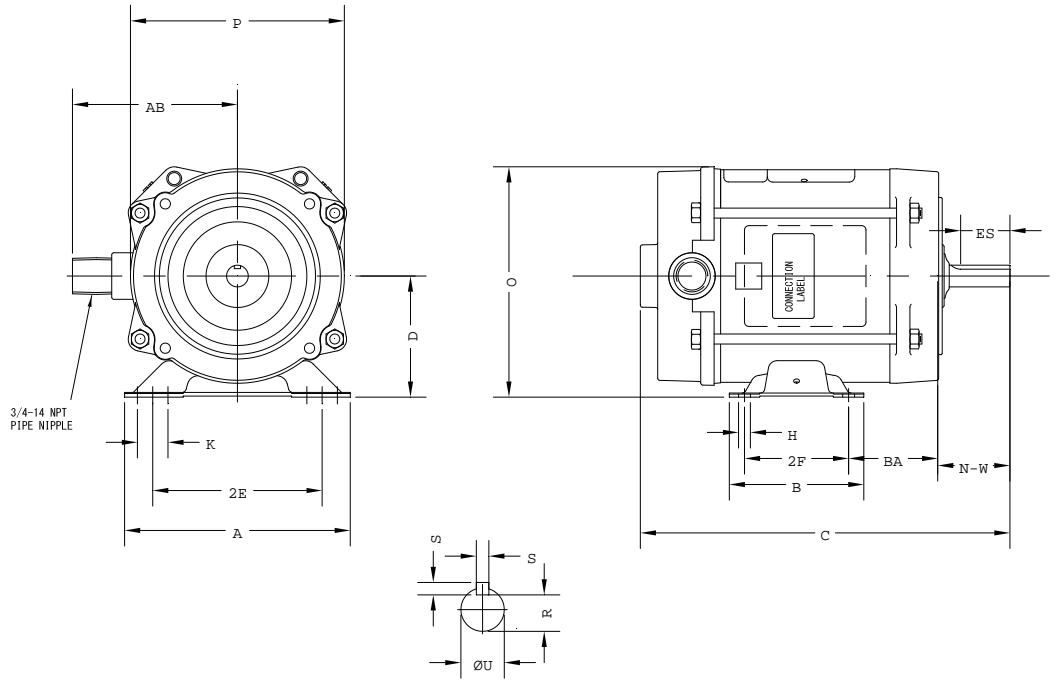

Notes: Downloaded from <http://dealerselectric.com>
Generated for Model #.3336XS3E56

Performed by:

Checked:

Customer:

Three-Phase: Fractional Explosion Proof Motors

2E	A	P	B	BA
4.880	6.500	6.980	3.880	2.750
U	N-W	ES	S	R
0.6250	1.880	1.380	0.190	0.517
D	O	H	C	d1
3.500	6.920	0.340	10.520	SEM

Three-phase induction motor
Frame 56 - IP55

12-SEP-2016

