



Dealers Industrial Equipment

No.:

Date: 12-SEP-2016

Customer :

TECHNICAL PROPOSAL

Single-phase induction motor - Squirrel cage rotor

Product line : Single Phase: W01 (Rolled Steel) - TEFC - Standard Efficiency

Catalog Number : .2536ES1BW56C-S

List Price : \$280

Notes:

Downloaded from <http://dealerselectric.com>

Generated for Model #.2536ES1BW56C-S

Performed by:

Checked:



Dealers Industrial Equipment

No.:

Date: 12-SEP-2016

DATA SHEET

Single-phase induction motor - Squirrel cage rotor

Customer :
Product line : Single Phase: W01 (Rolled Steel) - TEFC - Standard Efficiency

Frame : W56
Output : 0.25 HP
Frequency : 60 Hz
Poles : 2
Full load speed : 3485 rpm
Slip : 3.19 %
Voltage : 115/208-230 V
Rated current : 4.20/2.32-2.10 A
Locked rotor current : 27.7/13.8 A
Locked rotor current (I_L/I_n) : 6.6
No-load current : 3.20/1.60 A
Full load torque : 0.372 lb.ft
Locked rotor torque : 290 %
Breakdown torque : 300 %
Design : ---
Insulation class : F
Temperature rise : 80 K
Locked rotor time : 11 s (hot)
Service factor : 1.15 (1.00 at 208V)
Duty cycle : S1
Ambient temperature : -20°C - +40°C
Altitude : 1000 m
Degree of Protection : IP55
Approximate weight : 17 lb
Moment of inertia : 0.01471 sq.ft.lb
Noise level : 66 dB(A)

	D.E.	N.D.E.	Load	Power factor	Efficiency (%)
Bearings	6203 ZZ	6202 ZZ	100%	0.74	50.0
Regreasing interval	---	---	75%	0.68	44.0
Grease amount	---	---	50%	0.60	35.0

Notes:

Downloaded from <http://dealerselectric.com>
Generated for Model #.2536ES1BW56C-S

Performed by

Checked



Dealers Industrial Equipment

No.:

Date: 12-SEP-2016

PERFORMANCE CURVES RELATED TO RATED OUTPUT

Single-phase induction motor - Squirrel cage rotor

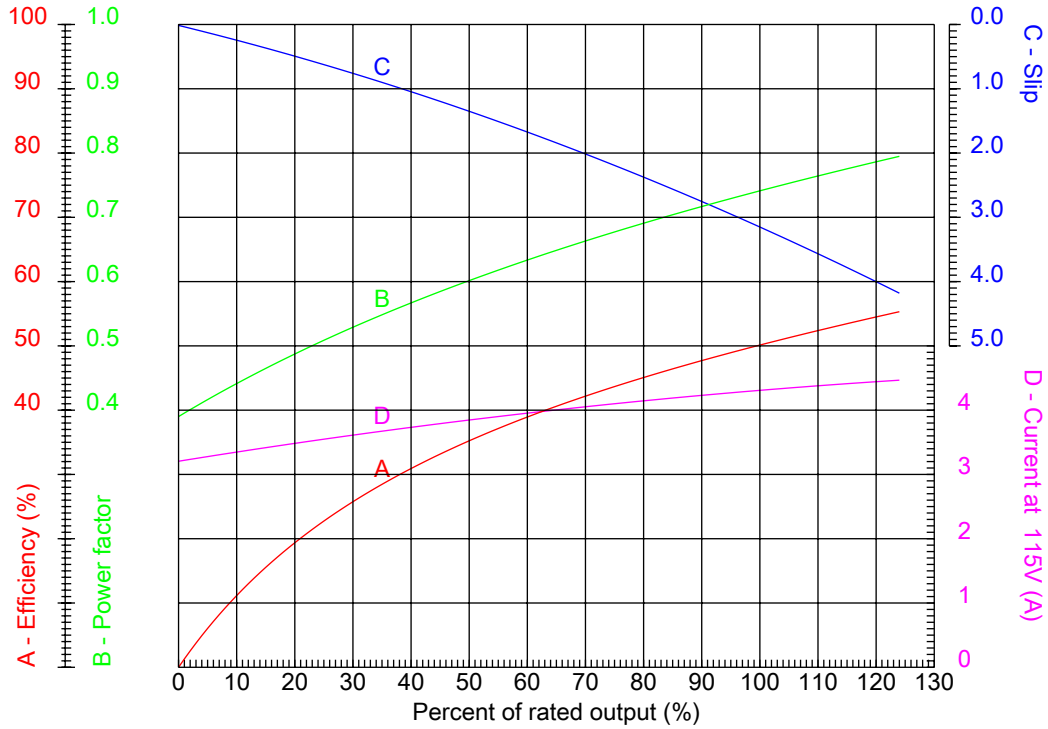

Customer :
 Product line : Single Phase: W01 (Rolled Steel) - TEFC - Standard Efficiency

Frame	: W56	Locked rotor current (I _l /I _n)	: 6.6
Output	: 0.25 HP	Duty cycle	: S1
Frequency	: 60 Hz	Service factor	: 1.15 (1.00 at 208V)
Full load speed	: 3485 rpm	Design	: ---
Voltage	: 115/208-230 V	Locked rotor torque	: 290 %
Rated current	: 4.20/2.32-2.10 A	Breakdown torque	: 300 %
Insulation class	: F		

Notes:
 Downloaded from <http://dealerselectric.com>
 Generated for Model #.2536ES1BW56C-S

Performed by

Checked

1 2 3 4 5 6 7 8

A

B

C

D

E

F

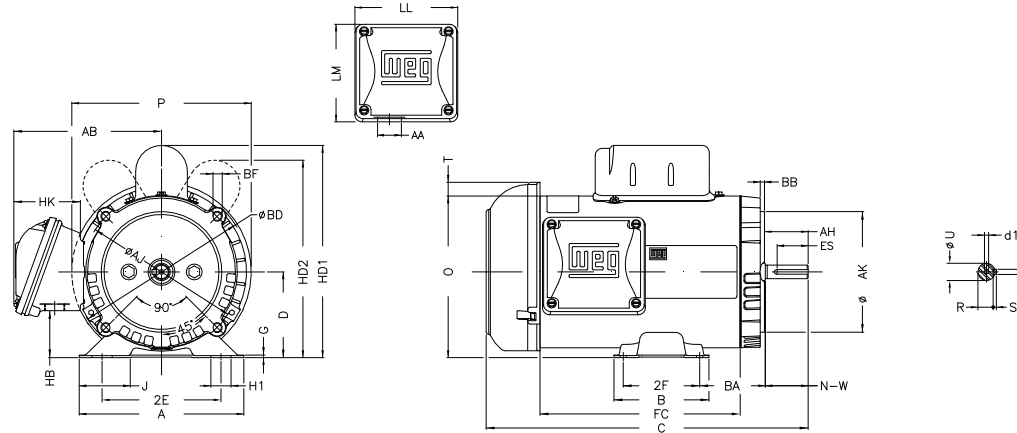

Notes: Downloaded from <http://dealerselectric.com>
Generated for Model #.2536ES1BW56C-S

Performed by:

Checked:

Customer:

Single Phase: W01 (Rolled Steel) - TEFC - Standard Efficiency

Single-phase induction motor
Frame W56 - IP55

12-SEP-2016



P	AB	J	2E	A
6.693	5.520	1.620	4.874	6.535
H	G	HB	HK	XO
0.343	0.075	2.055	2.650	0.524
O	FC	2F	B	C
6.330	5.906	3.000	4.016	10.713
BA	N-W	ES	d1	S
2.750	1.874	1.417	A 3,15	0.187
U	AA	depth	R	LL
0.625	0.881"	0.187	0.517	3.835
LM	D	CH	HD'	HC1
3.697	3.500	1.417	8.189	4.717
Flange	AJ	AK	BD	BF
FC-149	5.874	4.500	6.470	UNC 3/8"x16-2B
BB	AH			
0.157	2.063			