



Dealers Industrial Equipment

No.:

Date: 12-SEP-2016

Customer :

TECHNICAL PROPOSAL

Three-phase induction motor - Squirrel cage rotor

Product line : Three-Phase : NEMA 56 Frames - ODP

Catalog Number : .2512OS3EA56C

List Price : \$275

Notes:

Downloaded from <http://dealerselectric.com>

Generated for Model #.2512OS3EA56C

Performed by:

Checked:



Dealers Industrial Equipment

No.:

Date: 12-SEP-2016

DATA SHEET Three-phase induction motor - Squirrel cage rotor

Customer :
Product line : Three-Phase : NEMA 56 Frames - ODP

Frame : A56
Output : 0.25 HP
Frequency : 60 Hz
Poles : 6
Full load speed : 1150 rpm
Slip : 4.17 %
Voltage : 208-230/460 V
Rated current : 1.33-1.50/0.750 A
Locked rotor current : 5.70/2.85 A
Locked rotor current (I_L/I_n) : 3.8
No-load current : 1.40/0.700 A
Full load torque : 1.13 lb.ft
Locked rotor torque : 280 %
Breakdown torque : 310 %
Design : A
Insulation class : B
Temperature rise : 80 K
Locked rotor time : 15 s (hot)
Service factor : 1.35 (1.00 at 208V)
Duty cycle : S1
Ambient temperature : -20°C - +40°C
Altitude : 1000 m
Degree of Protection : IP21
Approximate weight : 18 lb
Moment of inertia : 0.04556 sq.ft.lb
Noise level : ---

	D.E.	N.D.E.
Bearings	6204 ZZ	6203 ZZ
Regreasing interval	---	---
Grease amount	---	---

Load	Power factor	Efficiency (%)
100%	0.59	55.0
75%	0.52	50.0
50%	0.43	40.0

Notes:
Downloaded from <http://dealerselectric.com>
Generated for Model #.2512OS3EA56C

Performed by

Checked



Dealers Industrial Equipment

No.:

Date: 12-SEP-2016

PERFORMANCE CURVES RELATED TO RATED OUTPUT

Three-phase induction motor - Squirrel cage rotor

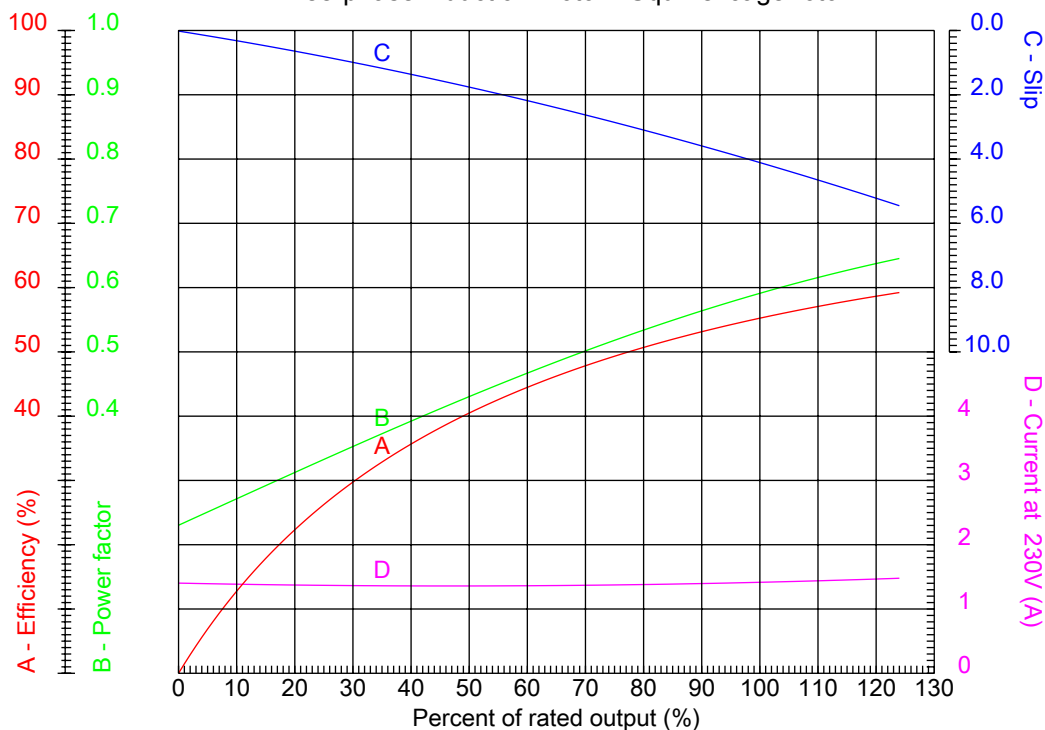

Customer :
 Product line : Three-Phase : NEMA 56 Frames - ODP

Frame	: A56	Locked rotor current (I _L /I _n)	: 3.8
Output	: 0.25 HP	Duty cycle	: S1
Frequency	: 60 Hz	Service factor	: 1.35 (1.00 at 208V)
Full load speed	: 1150 rpm	Design	: A
Voltage	: 208-230/460 V	Locked rotor torque	: 280 %
Rated current	: 1.33-1.50/0.750 A	Breakdown torque	: 310 %
Insulation class	: B		

Notes:
 Downloaded from <http://dealerselectric.com>
 Generated for Model #.2512OS3EA56C

Performed by

Checked



Dealers Industrial Equipment

No.:

Date: 12-SEP-2016

CHARACTERISTIC CURVES RELATED TO SPEED

Three-phase induction motor - Squirrel cage rotor

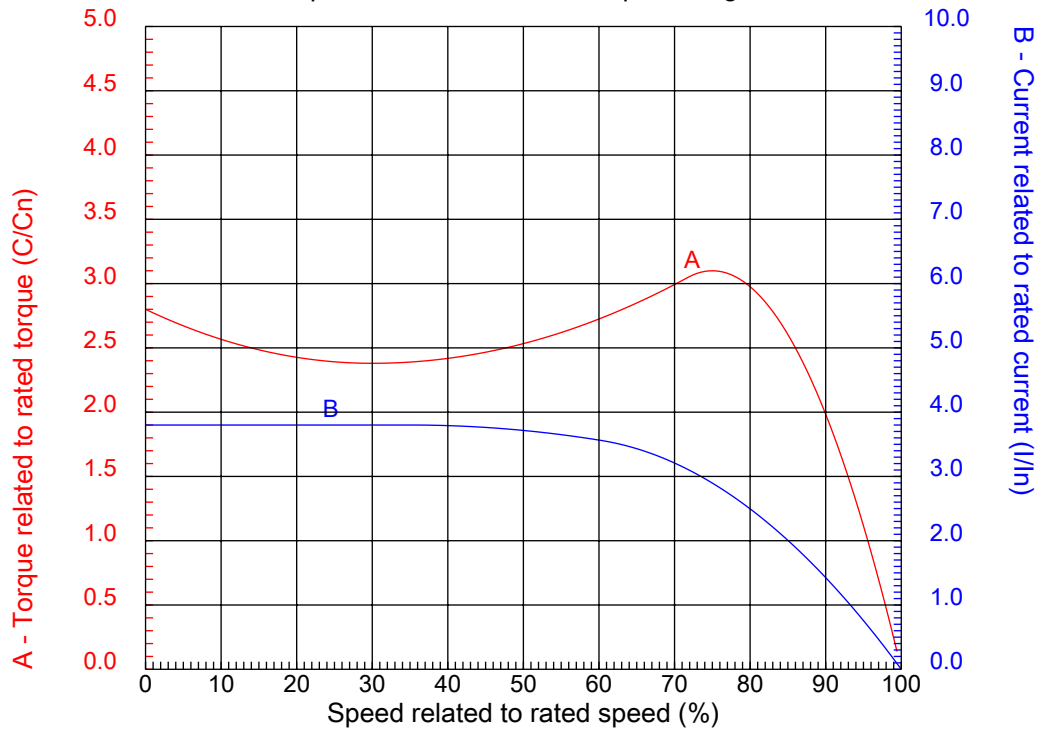

Customer :
Product line : Three-Phase : NEMA 56 Frames - ODP

Frame	: A56	Locked rotor current (I _l /I _n)	: 3.8
Output	: 0.25 HP	Duty cycle	: S1
Frequency	: 60 Hz	Service factor	: 1.35 (1.00 at 208V)
Full load speed	: 1150 rpm	Design	: A
Voltage	: 208-230/460 V	Locked rotor torque	: 280 %
Rated current	: 1.33-1.50/0.750 A	Breakdown torque	: 310 %
Insulation class	: B		

Notes:
Downloaded from <http://dealerselectric.com>
Generated for Model #.2512OS3EA56C

Performed by

Checked

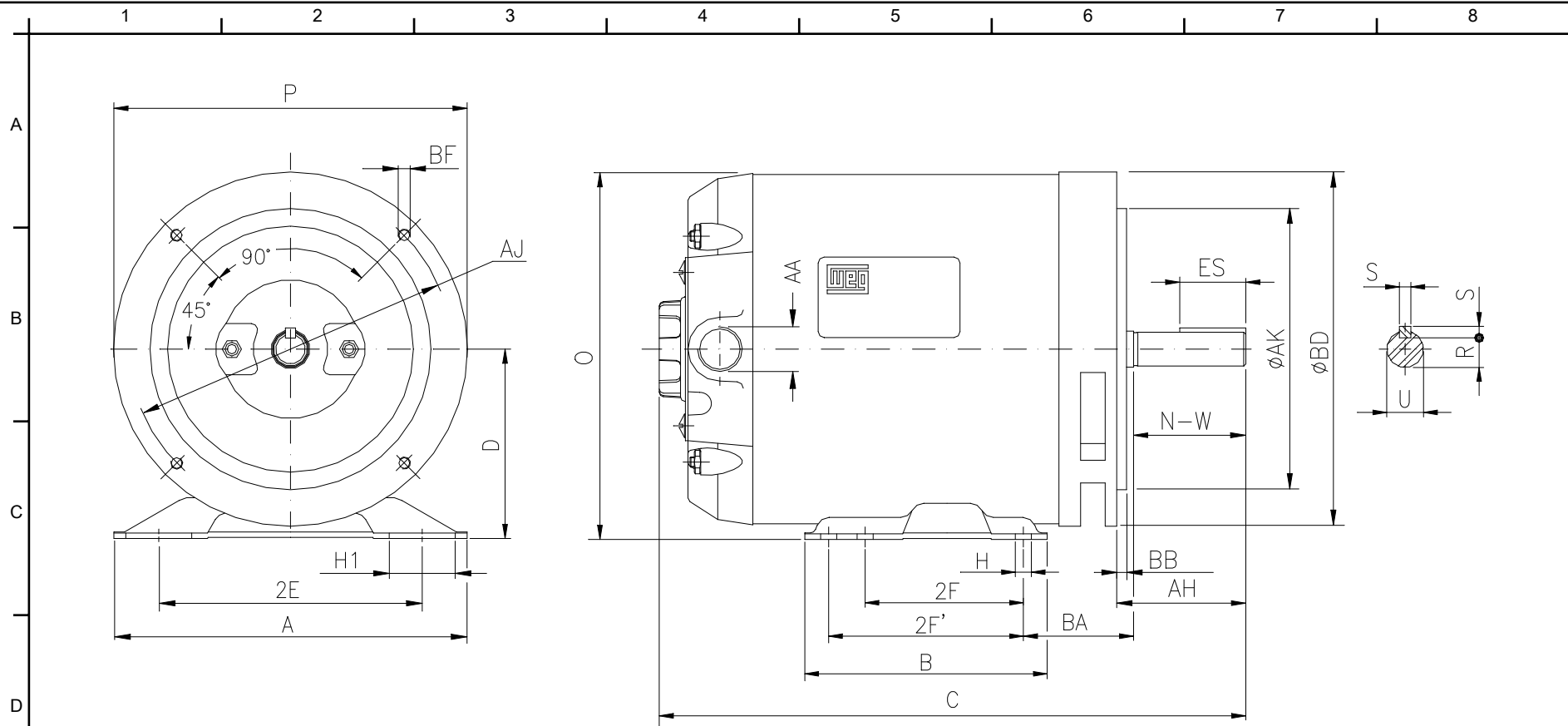

Notes: Downloaded from <http://dealerselectric.com>
 Generated for Model #.2512OS3EA56C

Performed by:

Checked:

Customer:

Three-Phase : NEMA 56 Frames - ODP

Three-phase induction motor
 Frame A56 - IP21

12-SEP-2016



2E 4.874	H 0.342	A 6.535	2F 3.000	B 6.496
G 3.04	BA 2.750	J 1.220	P 6.496	ES 1.102
S 0.187	N-W 1.874	depth 0.187	U 0.6250	R 0.517
D 3.500	O 6.771	C 10.315	AA NPT 1/2"	Flange FC-149
AJ 5.874	AK 4.500	BD 6.535	BF UNC 3/8"x16-2B	BB 0.157

1 2 3 4 5 6 7 8

A

LOW VOLTAGE

HIGH VOLTAGE

B



C



D

E

F

Notes: Downloaded from <http://dealerselectric.com>
 Generated for Model #.2512OS3EA56C

Performed by:

Checked:

Customer:

Three-Phase : NEMA 56 Frames - ODP

Three-phase induction motor
 Frame A56 - IP21

12-SEP-2016

