



Dealers Industrial Equipment

No.:

Date: 12-SEP-2016

Customer :

TECHNICAL PROPOSAL

Three-phase induction motor - Squirrel cage rotor

Product line : Three-Phase : IEC Tru-Metric - TEFC (IP55) - Aluminum Frame

Catalog Number : .1809EP3WAL80

List Price : \$540

Notes:

Downloaded from <http://dealerselectric.com>

Generated for Model #.1809EP3WAL80

Performed by:

Checked:



Dealers Industrial Equipment

No.:

Date: 12-SEP-2016

DATA SHEET Three-phase induction motor - Squirrel cage rotor

Customer :
 Product line : Three-Phase : IEC Tru-Metric - TEFC (IP55) - Aluminum Frame

Frame : 80
 Output : 0.25 HP
 Frequency : 60 Hz
 Poles : 8
 Full load speed : 860 rpm
 Slip : 4.44 %
 Voltage : 460 V
 Rated current : 0.799 A
 Locked rotor current : 2.64 A
 Locked rotor current (I_L/I_n) : 3.3
 No-load current : 0.810 A
 Full load torque : 1.51 lb.ft
 Locked rotor torque : 200 %
 Breakdown torque : 240 %
 Design : ---
 Insulation class : F
 Temperature rise : 80 K
 Locked rotor time : 8 s (hot)
 Service factor : 1.15
 Duty cycle : S1
 Ambient temperature : -20°C - +40°C
 Altitude : 1000 m
 Degree of Protection : IP55
 Approximate weight : 25 lb
 Moment of inertia : 0.05743 sq.ft.lb
 Noise level : 46 dB(A)

	D.E.	N.D.E.
Bearings	6204 ZZ	6203 ZZ
Regreasing interval	---	---
Grease amount	---	---

Load	Power factor	Efficiency (%)
100%	0.56	50.5
75%	0.48	43.3
50%	0.40	34.6

Notes:
 Downloaded from <http://dealerselectric.com>
 Generated for Model #.1809EP3WAL80

Performed by

Checked



Dealers Industrial Equipment

No.:

Date: 12-SEP-2016

PERFORMANCE CURVES RELATED TO RATED OUTPUT

Three-phase induction motor - Squirrel cage rotor

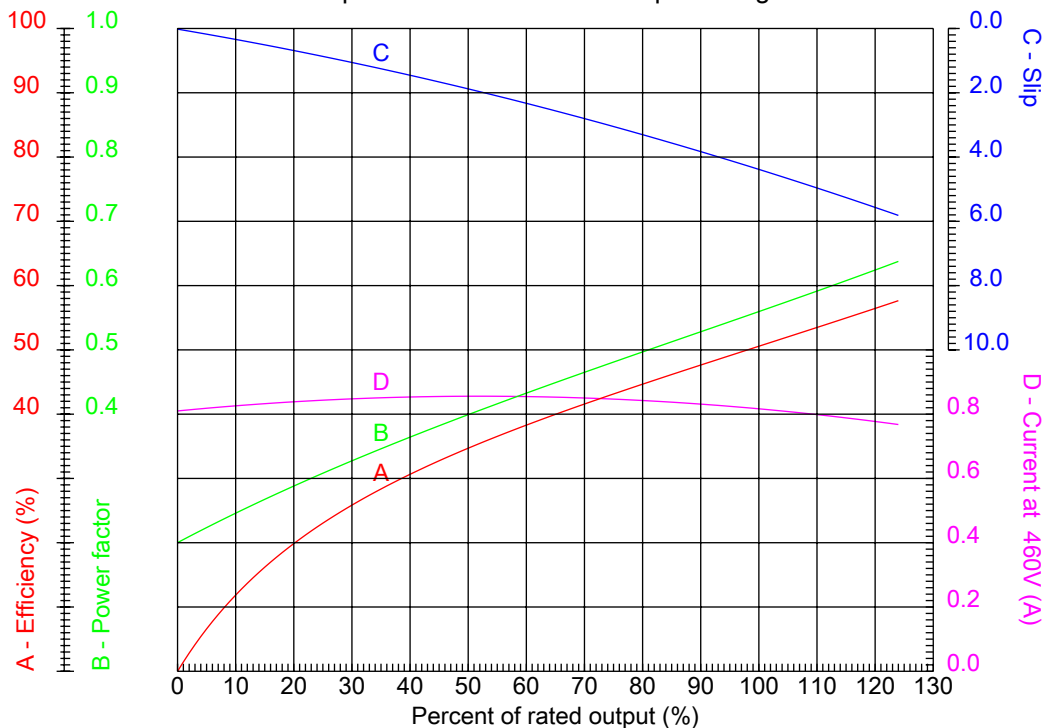

Customer :
 Product line : Three-Phase : IEC Tru-Metric - TEFC (IP55) - Aluminum Frame

Frame	: 80	Locked rotor current (I _L /I _n)	: 3.3
Output	: 0.25 HP	Duty cycle	: S1
Frequency	: 60 Hz	Service factor	: 1.15
Full load speed	: 860 rpm	Design	: ---
Voltage	: 460 V	Locked rotor torque	: 200 %
Rated current	: 0.799 A	Breakdown torque	: 240 %
Insulation class	: F		

Notes:
 Downloaded from <http://dealerselectric.com>
 Generated for Model #.1809EP3WAL80

Performed by

Checked



Dealers Industrial Equipment

No.:

Date: 12-SEP-2016

CHARACTERISTIC CURVES RELATED TO SPEED

Three-phase induction motor - Squirrel cage rotor

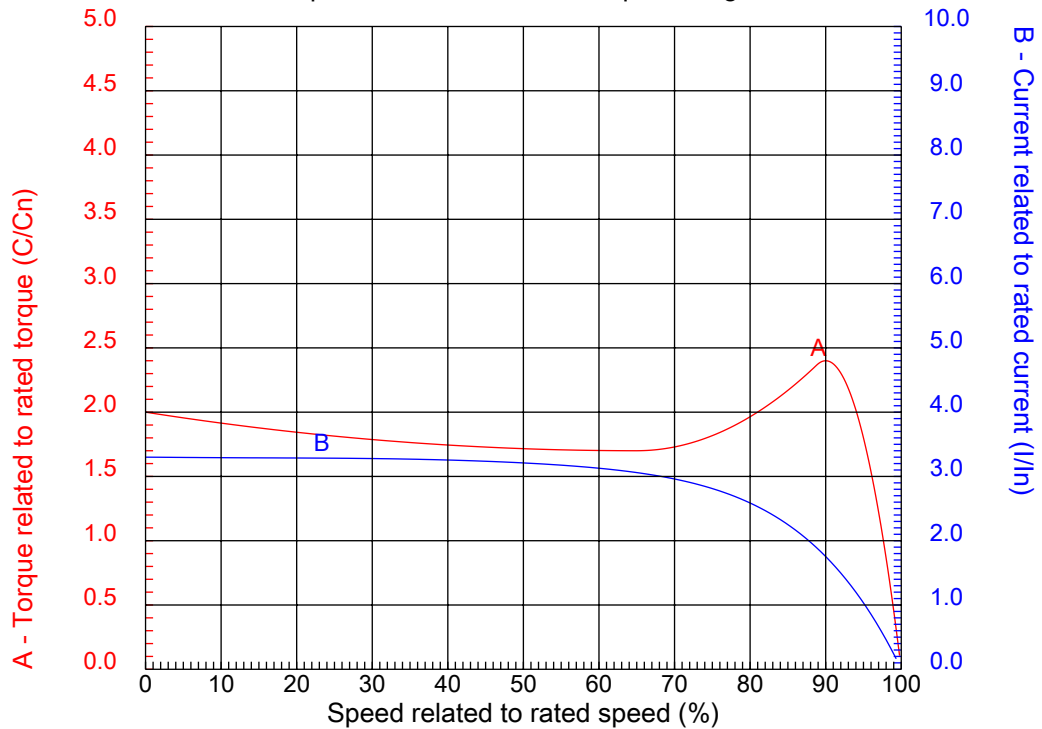

Customer :
Product line : Three-Phase : IEC Tru-Metric - TEFC (IP55) - Aluminum Frame

Frame	: 80	Locked rotor current (I _l /I _n)	: 3.3
Output	: 0.25 HP	Duty cycle	: S1
Frequency	: 60 Hz	Service factor	: 1.15
Full load speed	: 860 rpm	Design	: ---
Voltage	: 460 V	Locked rotor torque	: 200 %
Rated current	: 0.799 A	Breakdown torque	: 240 %
Insulation class	: F		

Notes:
Downloaded from <http://dealerselectric.com>
Generated for Model #.1809EP3WAL80

Performed by

Checked

1 2 3 4 5 6 7 8

A
B
C
D
E
F

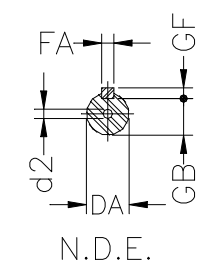
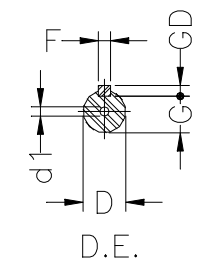
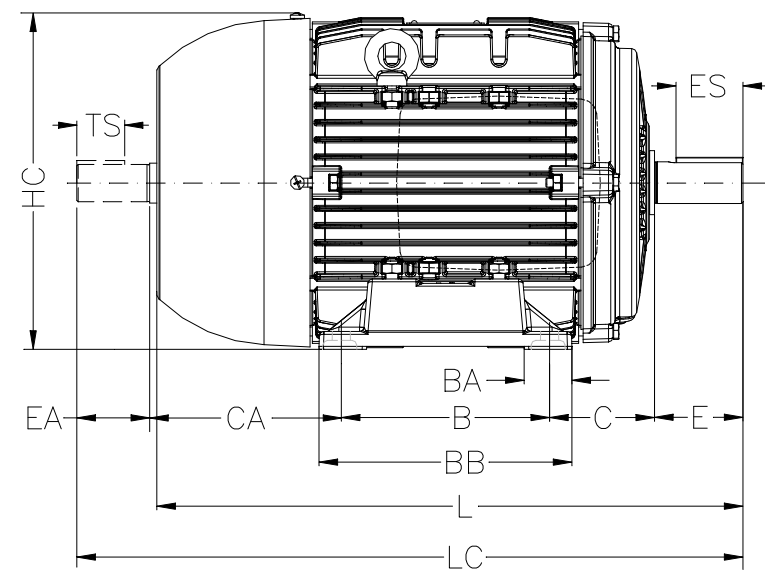
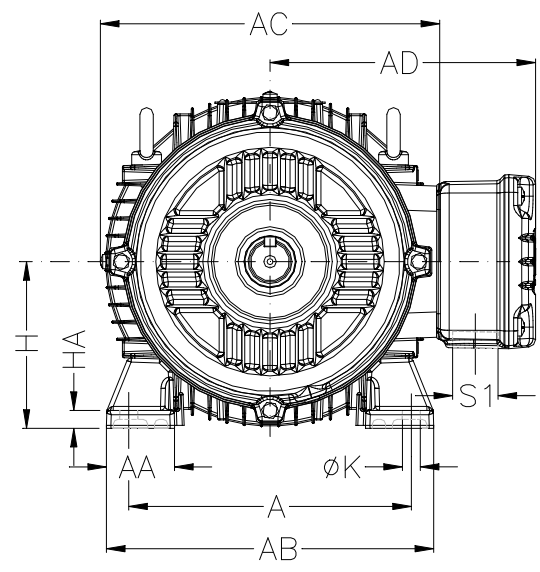

Notes: Downloaded from <http://dealerselectric.com>
Generated for Model #.1809EP3WAL80

A	AA	AB	AC	AD
125	32	155	159	135.5
B	BA	BB	C	CA
100	28	124	50	93
D	E	ES	F	G
19j6	40	28	6	15.5
GD	DA	EA	TS	FA
6	14j6	30	18	5
GB	GF	H	HA	HC
11	5	80	8	157
HD	K	L	LC	S1
210	10	276	313	NPT 3/4"
d1	d2			
DM6	DM4			

Performed by:

Checked:

Customer:

Three-Phase : IEC Tru-Metric - TEFC (IP55) - Aluminum Frame

Three-phase induction motor
Frame 80 - IP55

12-SEP-2016

