

1 2 3 4 5 6 7 8

A

B

C

D

E

F

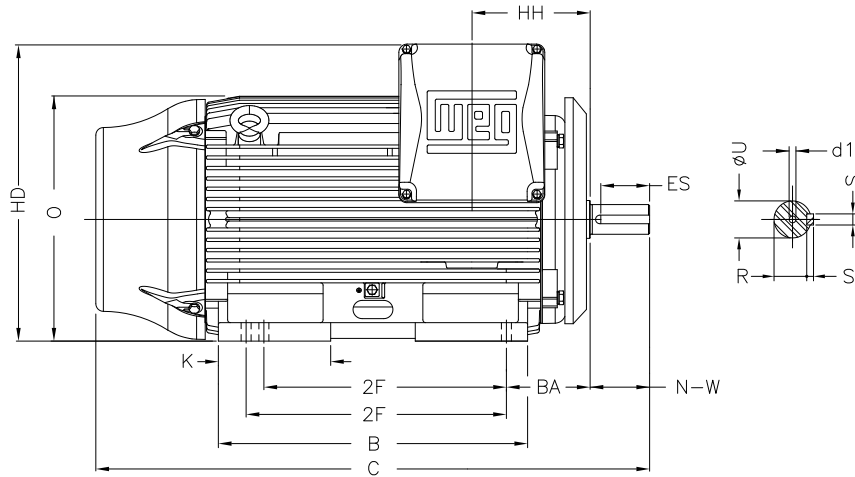
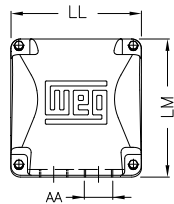
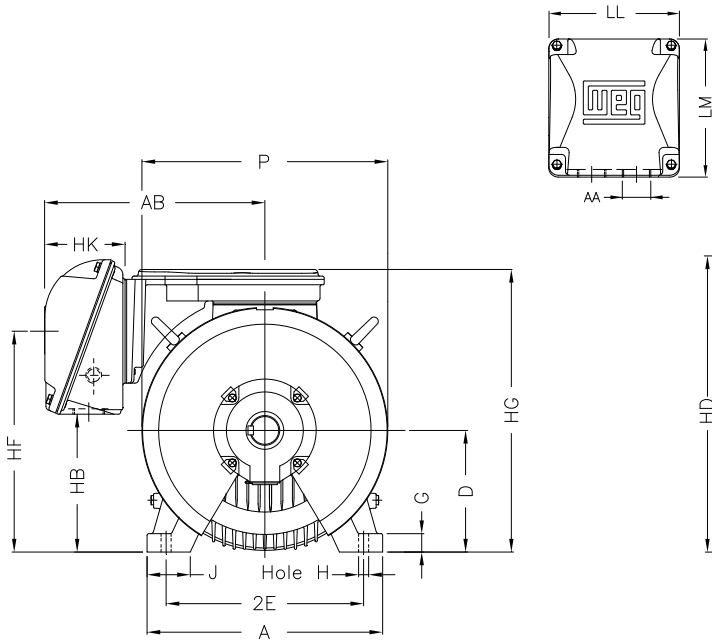

Notes: Downloaded from <http://dealerselectric.com>
Generated for Model #75018ET3G588/9-W22

2E 23.000	J 5.512	A 29.528	P 28.977	AB 27.440
2F 28.000/32.000	K 13.030	B 37.980	BA 10.000	U 3.875
N-W 11.625	ES 8.661	S 1.000	R 3.312	depth 1.000
D 14.500	G 2.492	HB 16.338	O 28.985	HD 37.755
HF 26.182	HG 35.236	HH 13.346	HK 11.417	EV 2.756
H 1.181	C 69.381	LL 18.110	LM 21.417	AA 2xNPT 4"
d1 DUNC 7/8"-9				

Performed by:

Checked:

Customer:

W22 NEMA Premium - Ball Bearings

Three-phase induction motor
Frame 588/9T - IP55

29-SEP-2016

