

1 2 3 4 5 6 7 8

A
B
C
D
E
F

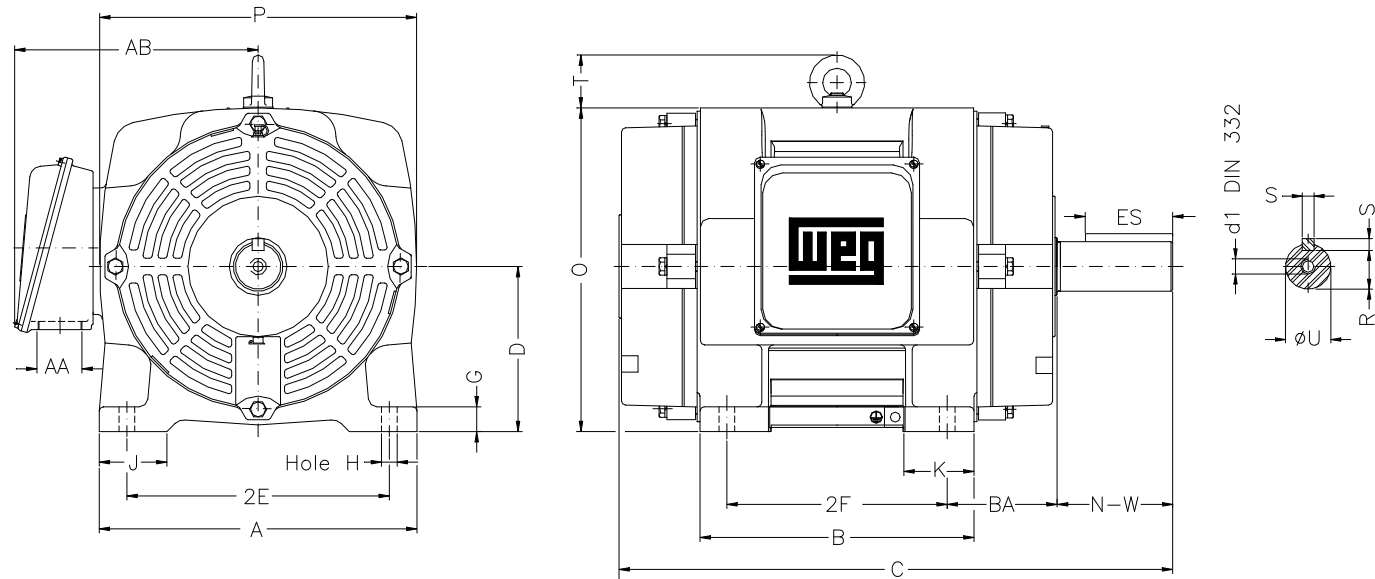

Notes: Downloaded from <http://dealerselectric.com>
Generated for Model #50036OP3G447/9TS

Performed by:

Checked:

Customer:

ODP – Open Induction Motors – High Efficiency

2E 18.000	A 21.929	2F 20.000/25.000	B 28.898	BA 7.500
J 3.937	K 10.47	P 22.126	ES 3.000	depth 0.625
S 0.625	D 11.000	N-W 4.750	G 1.811	U 2.375
O 22.441	T 3.543	R 2.019	H 0.807	AB 23.464
C 44.567	AA 2xNPT 3"	d1 DUNC 3/4"-10		

Three-phase induction motor
Frame 447/9TS - IP23

29-SEP-2016

