

1 2 3 4 5 6 7 8

A

B

C

D

E

F

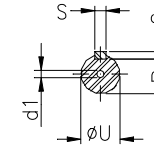
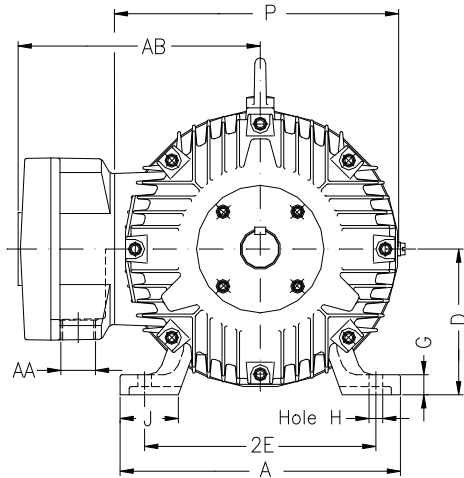

Notes: Downloaded from <http://dealerselectric.com>  
Generated for Model #50018XP3G586/7

Performed by:

Checked:

Customer:

Three-Phase : Explosion Proof - High Efficiency

Three-phase induction motor  
Frame 586/7T - IP54

29-SEP-2016



2E 23.000	A 29.528	2F 22.000/25.000	B 29.921	BA 10.00
J 5.236	K 7.874	P 30.709	ES 8.661	depth 1.000
S 1.000	N-W 11.625	U 3.875	R 3.312	AB 25.787
D 14.500	G 2.492	O 30.428	H 1.181	C 61.389
AA 2xNPT 3"	d1 DUNC 7/8"-9	d2 DUNC 3/4"-10	T 4.291	