

1 2 3 4 5 6 7 8

A
B
C
D
E
F

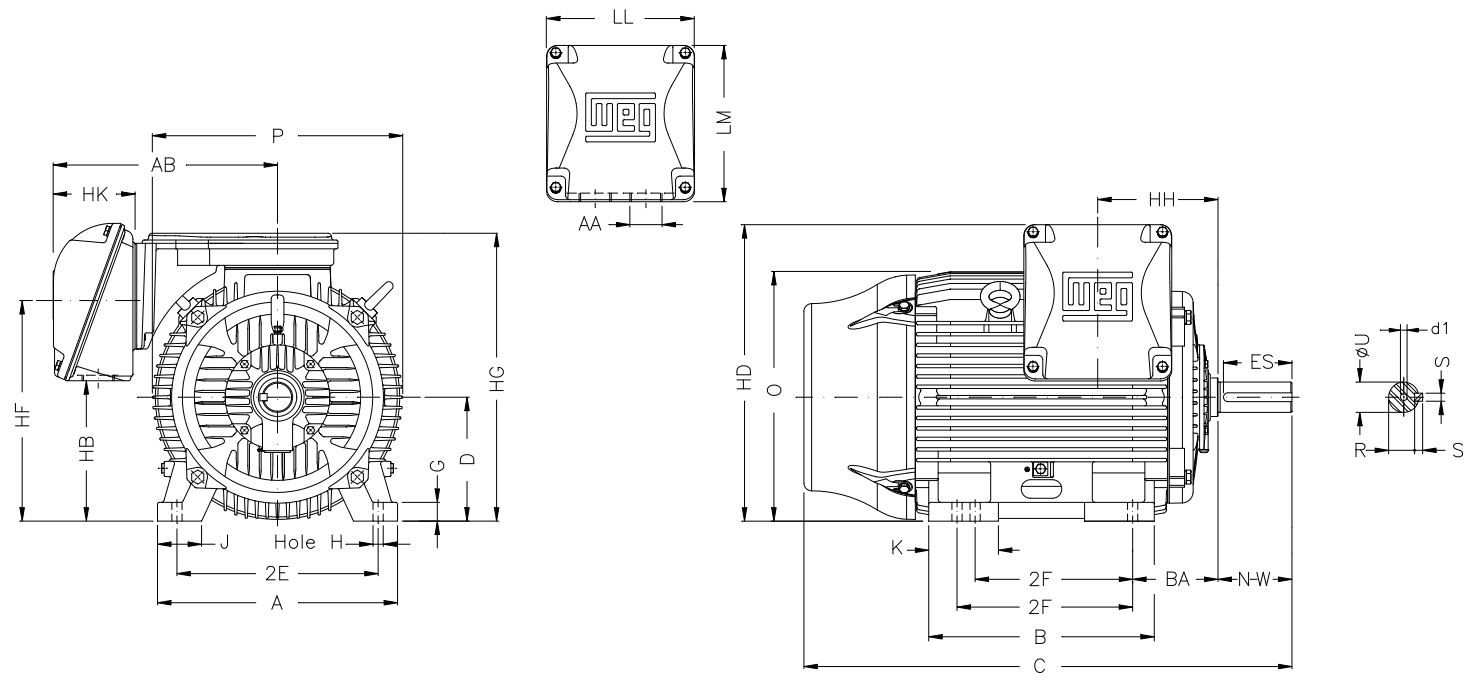

Notes: Downloaded from <http://dealerselectric.com>
Generated for Model #50012EP3GKD580Z-W22

2E 23.000	J 5.512	A 29.528	P 28.977	AB 23.189
2F 22.000/25.000	K 9.055	B 29.921	BA 10.000	U 4.375
N-W 11.625	ES 8.661	S 1.000	R 3.816	depth 1.000
D 14.500	G 2.492	HB 18.575	O 28.985	HD 35.740
HF 26.732	HG 35.236	HH 13.346	HK 8.661	H 1.181
C 61.902	LL 15.906	LM 17.165	AA 2xNPT 3"	d1 DUNC 7/8"-9
d2 DUNC 3/4"-10				

Performed by:	
Checked:	
Customer:	
Three-Phase: W22 Crusher Duty TEFC (IP55)	
Three-phase induction motor Frame 586/7Z - IP55	29-SEP-2016

