

1 2 3 4 5 6 7 8

A

B

C

D

E

F

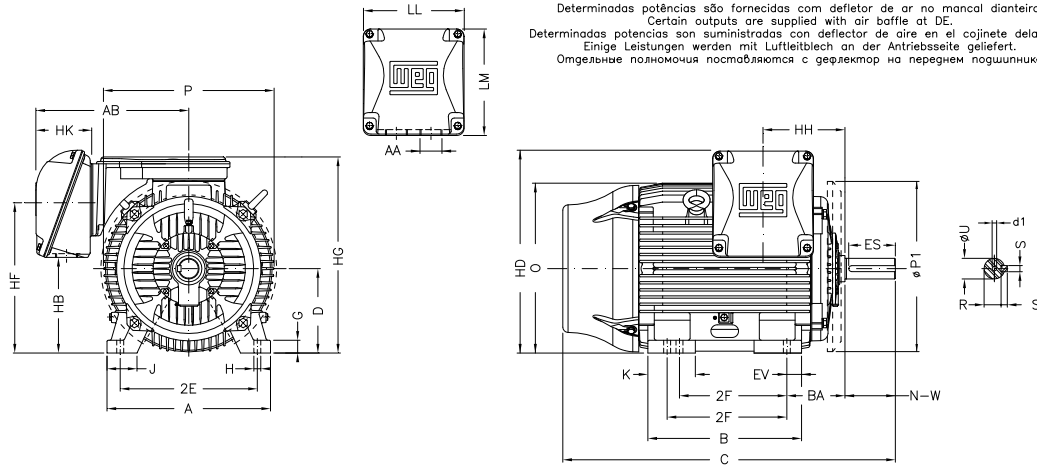

Notes: Downloaded from <http://dealerselectric.com>  
 Generated for Model #40012ET3G586/7-W22

2E 23.000	J 5.512	A 29.528	P 28.977	AB 23.189
2F 22.000/25.000	K 9.055	B 29.921	BA 10.000	U 3.875
N-W 11.625	ES 8.661	S 1.000	R 3.312	depth 1.000
D 14.500	G 2.492	HB 18.575	O 28.985	HD 35.740
HF 26.732	HG 35.236	HH 13.346	HK 8.661	EV 2.559
H 1.181	C 61.902	LL 15.906	LM 17.165	AA 2xNPT 3"
d1 DUNC 7/8"-9				

Performed by:	
Checked:	
Customer:	
W22 NEMA Premium - Ball Bearings	
Three-phase induction motor Frame 586/7T - IP55	29-SEP-2016

