

1 2 3 4 5 6 7 8

A

B

C

D

E

F

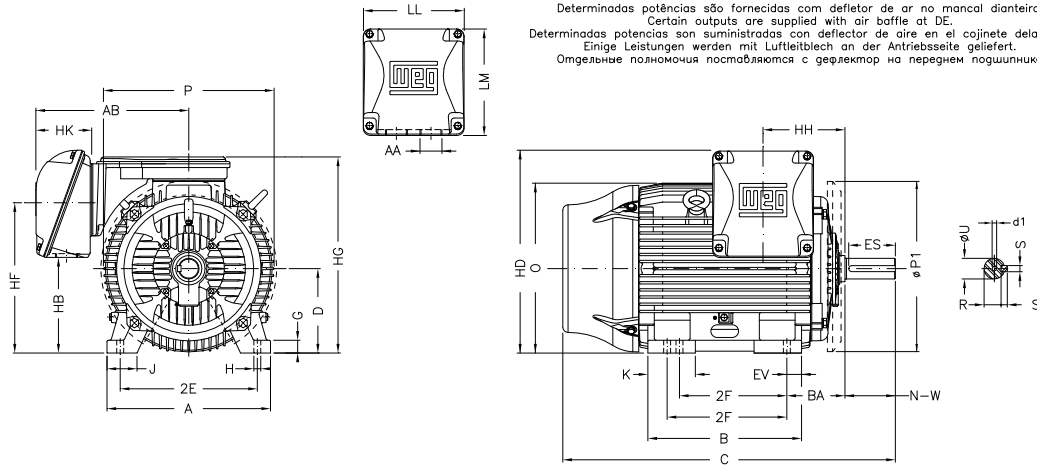

Determinadas potências são fornecidas com defletor de ar no mancal dianteiro.
 Certain outputs are supplied with air baffle at DE.
 Determinadas potencias son suministradas con deflector de aire en el cojinete delantero.
 Einige Leistungen werden mit Luftblech an der Antriebsseite geliefert.
 Отдельные полнomoчия поставляются с дефлектор на переднем подшипнике.

Notes: Downloaded from <http://dealerselectric.com>
 Generated for Model #40012ET3G449T-W22

2E 18.000	J 3.937	A 21.929	P 25.866	AB 23.720
2F 20.000/25.000	K 11.688	B 31.535	BA 7.500	U 3.375
N-W 8.500	ES 7.087	S 0.875	R 2.880	depth 0.875
D 11.000	G 1.630	HB 11.535	O 23.874	HD 30.708
HF 20.551	HG 28.185	HH 11.870	HK 8.661	EV 2.638
H 0.810	C 57.181	LL 15.906	LM 17.165	AA 2xNPT 3"
d1 DUNC 3/4"-10				

Performed by:	
Checked:	
Customer:	
W22 NEMA Premium - Ball Bearings	
Three-phase induction motor Frame L447/9T - IP55	29-SEP-2016

