

1 2 3 4 5 6 7 8

A

B

C

D

E

F

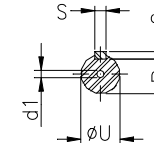
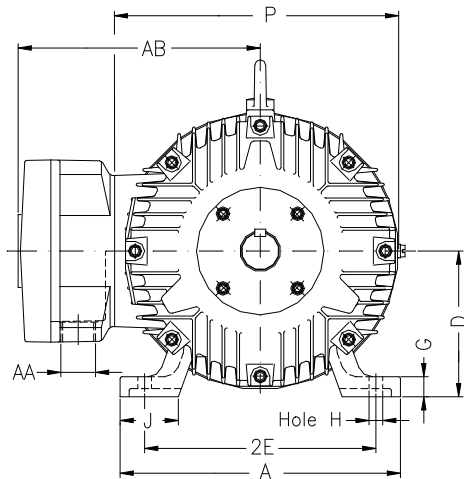

Notes: Downloaded from <http://dealerselectric.com>
Generated for Model #35018XT3G449T

Performed by:

Checked:

Customer:

Three-Phase : Explosion Proof - NEMA Premium

Three-phase induction motor
Frame 449T - IP55

29-SEP-2016



2E 18.000	A 21.929	2F 25.000	B 32.126	BA 7.500
J 3.937	K 7.104	P 24.016	ES 7.087	depth 0.875
S 0.875	N-W 8.500	U 3.375	R 2.880	AB 20.984
D 11.000	G 1.630	O 23.622	T 3.543	H 0.807
C 54.996	AA 2xNPT 3"	d1 DUNC 3/4"-10	d2 DUNC 3/4"-10	