

1 2 3 4 5 6 7 8

A

B

C

D

E

F

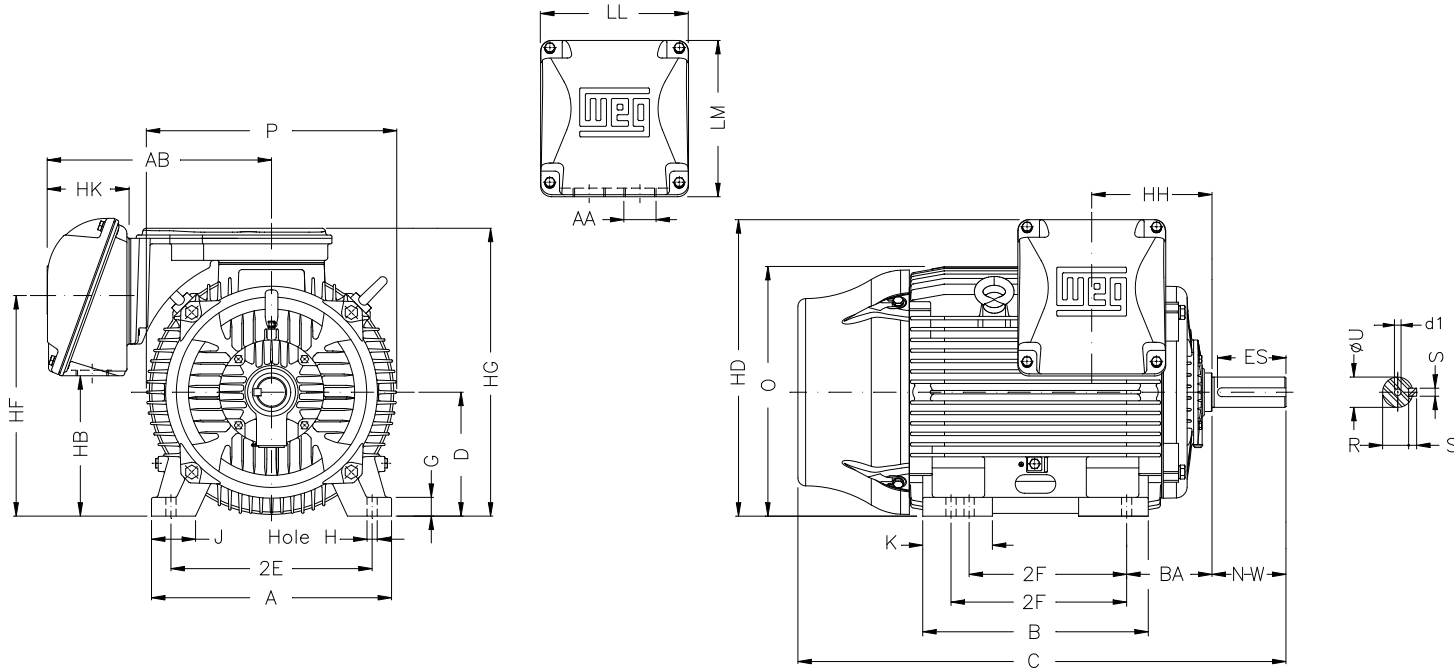

Notes: Downloaded from <http://dealerselectric.com>
Generated for Model #35018ET3GRB449T-W22

2E 18.000	J 3.937	A 21.929	P 23.583	AB 20.559
2F 20.000/25.000	K 11.772	B 31.535	BA 7.500	U 3.375
N-W 8.500	ES 7.087	S 0.875	R 2.880	depth 0.875
D 11.000	G 1.630	HB 12.488	O 22.795	HD 27.527
HF 20.724	HG 26.830	HH 11.811	HK 6.929	EV 1.929
H 0.810	C 56.338	LL 14.921	LM 15.039	AA 2xNPT 3"
d1 DUNC 3/4"-10				

Performed by:

Checked:

Customer:

W22 NEMA Premium - Roller Bearings

Three-phase induction motor
Frame 447/9T - IP55

29-SEP-2016

